



SURGIPROVE

SURGICAL SUPPLIERS

surgical/medical instruments



+923307020002



surgiprove@gmail.com



www.surgiprove.com



OUR BIG IDEA

Get top-quality surgical equipment delivered worldwide at unbeatable prices from our company...! We guaranty A grade quality with every purchase.



EQUIPMENT OVERVIEW

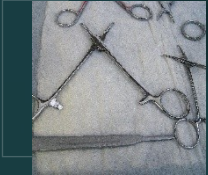

SURGICAL

All types of surgical equipment at unbeatable price

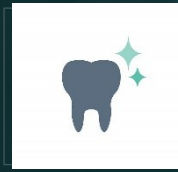

DENTAL

Also work in dental instruments with best quality

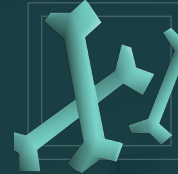

ORTHOPEDICS

We also deal with orthopedics instruments and implants.



VETERINARY

Reliable tools for compassionate pet care.



BEAUTY

Empowering beauty professionals with quality tools

Success

THE MARKET

CUSTOMER SEGMENTATION

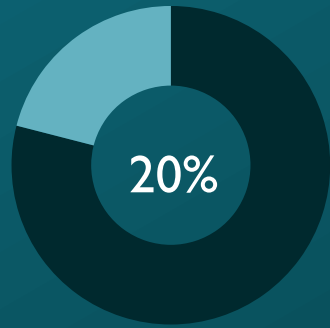

Orthopedic

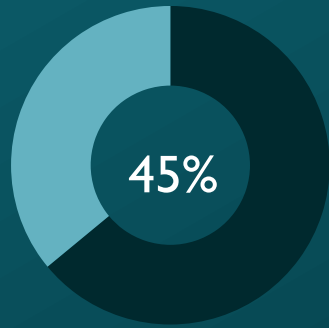

General surgery

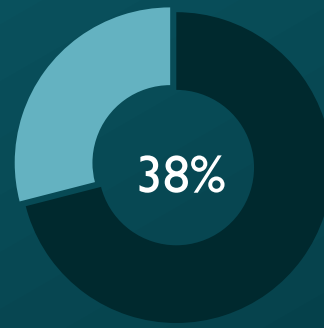

Dental

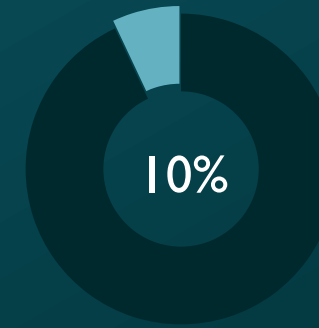

Veterinary

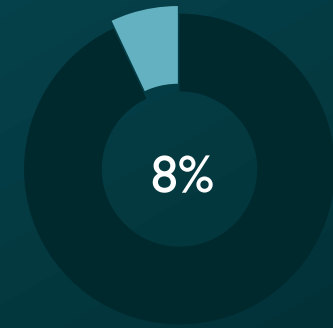

Beauty

Services	YR 1	GROWTH	YR 2	YR 3
Orthopedics instruments	\$230,880	10%	\$253,968	\$279,364
General surgery	\$506,160	8%	\$546,652	\$601,317
Dental equipment	\$44,400	10%	\$48,840	\$53,724
Veterinary	\$115,440	7%	\$123,520	\$132,166
Beauty equipment	\$35,520	5%	\$37,296	\$39,160
TOTAL	\$888,000*	\$70000	\$1,010,276	\$1,105,731

OUR SERVICES



Extended Office Hours

24 Hours available



Pediatric and Family Medical Services

'Trusted medical care for every stage of life'



In-house Delivery

Delivering surgical equipments for a healthier tomorrow.



Call-in Available

"Let us help you find the right equipment for your facility- contact us now"



Surplus Medical Supplies

"Gently used surgical equipment for sale- certified and tested"

IN-DEMAND SERVICES



General Surgery

- Essential tools for modern surgeons.
- Empowering surgeons with top-tier equipment for exceptional patient outcomes.
- High-demand equipment for precise procedures..



Ortho spine

- Precision Ortho Spine solutions for optimal patient care.
- Transforming spine surgery with innovative, in-demand equipment for superior outcomes.
- High-performance equipment for Ortho Spine specialists.



Neurosurgery

- Advanced neurosurgery equipment for delicate procedures.
- Innovative Neurosurgery Solutions, illuminating the path to better outcomes.
- Expert care for the most complex cases, trusted Neurosurgery equipment for superior results.

SALES FORECAST

3 YEAR SALES FORECAST

3 YEAR SALES SUMMARY	YR1	YR2	YR3
TOTAL SALES	\$888,000	\$1,065,600	\$1,278,720
TOTAL COGS	\$634,824	\$666,565	\$699,893
NET PROFIT	\$253,176	\$549,600	\$578,827

Annual Sales & Gross Profit

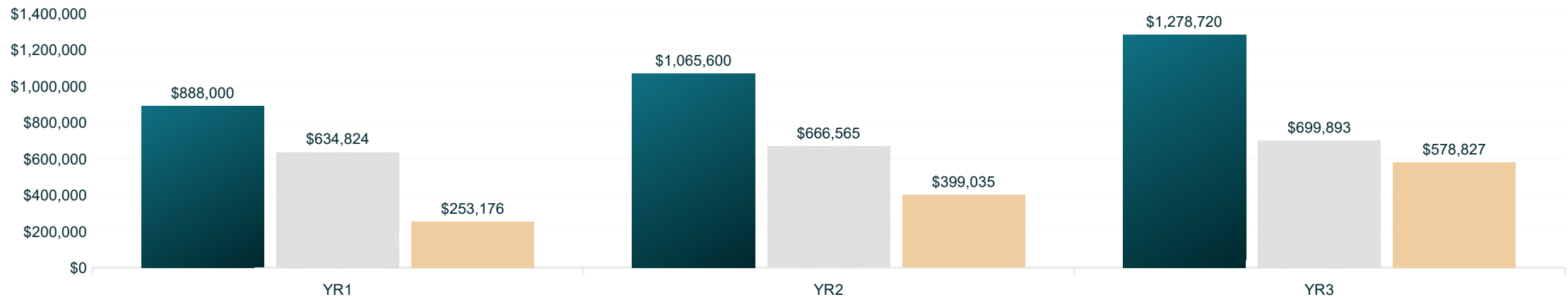



DIAGNOSTIC SET

DIAGNOSTIC SET

(ENT COMPLETE) ✓

101-0001

Consisting of Battery Handle (without battery)

3 Ear specula, 1 Nasal specula, 2 Laryngeal mirrors with holder

1 tongue depressor holder, 1 Bulb



OTOSCOPE
SET

OTOSCOPE SET

101-0002

Consisting of Battery Handel (without battery) 3 Ear Specula, 1Bulb

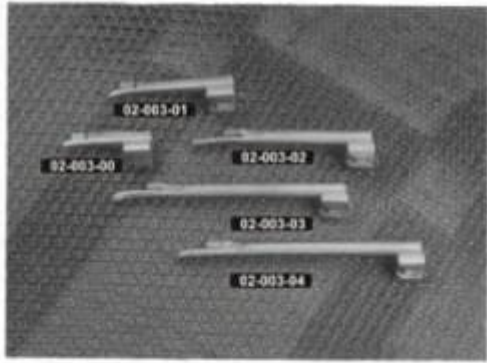

MILLER

MILLER

101-0003

Laryngoscope Set

CATHETER FORCEPS & LARYNGOSCOPE

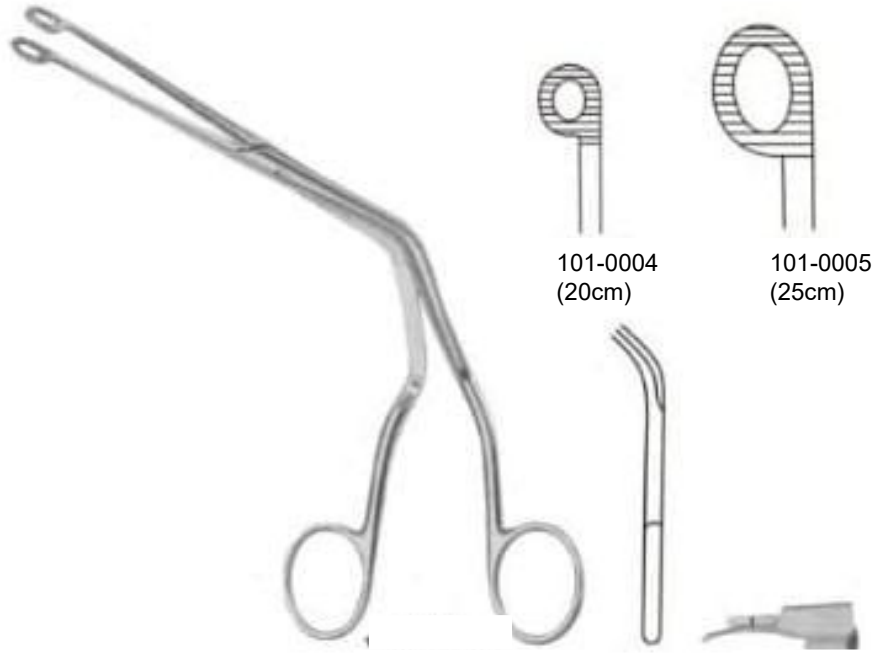

101-0004
(20cm)

101-0005
(25cm)

Magill
101-0004to101-0005

101-0007

101-0008

101-0009

101-00010

101-00011



McIntosh laryngoscope Set
101-0006

McIntosh

SURGICAL HANDLES



NO.3L 102-0001
ERGONOMIC NO.7 102-0002
NO.7 102-0003

102-0004
102-0005
102-0006

 +923307020002

 surgiprove@gmail.com

 www.surgiprove.com

SURGICAL HANDLES

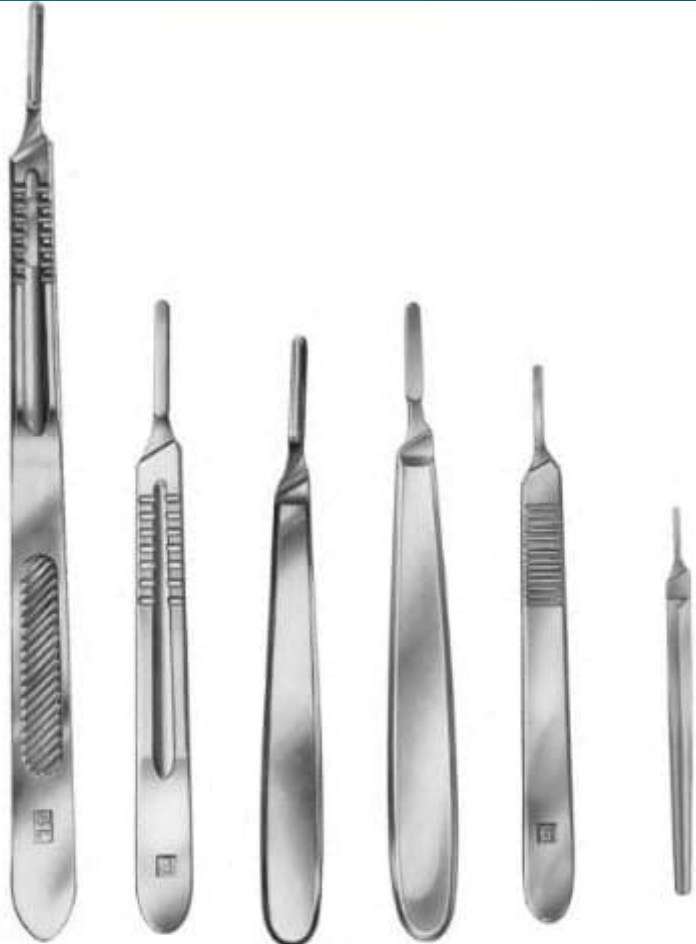

NO.4L 102-0007
NO.4 102-0008
NO.10 102-0009
NO.9 102-0010
NO.3 102-0011

BARRON 102-0012
For 'B.P.' types blades for use
with NO'S 10,11,12 &15 blades
135mm (5.1/4")

SCISSORS

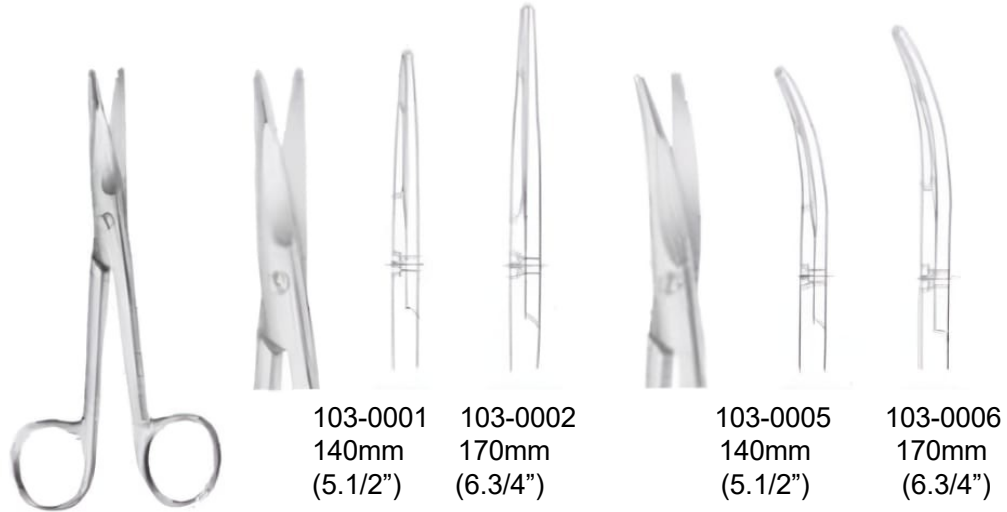

MAYO
Straight, beveled blades

103-0001 140mm (5.1/2")	103-0002 170mm (6.3/4")	103-0005 140mm (5.1/2")	103-0006 170mm (6.3/4")
103-0003 190mm (7.1/2")	103-0004 215mm (8.1/2")	103-0007 190mm (7.1/2")	103-0008 215mm (8.1/2")

Curved on flat, beveled blades

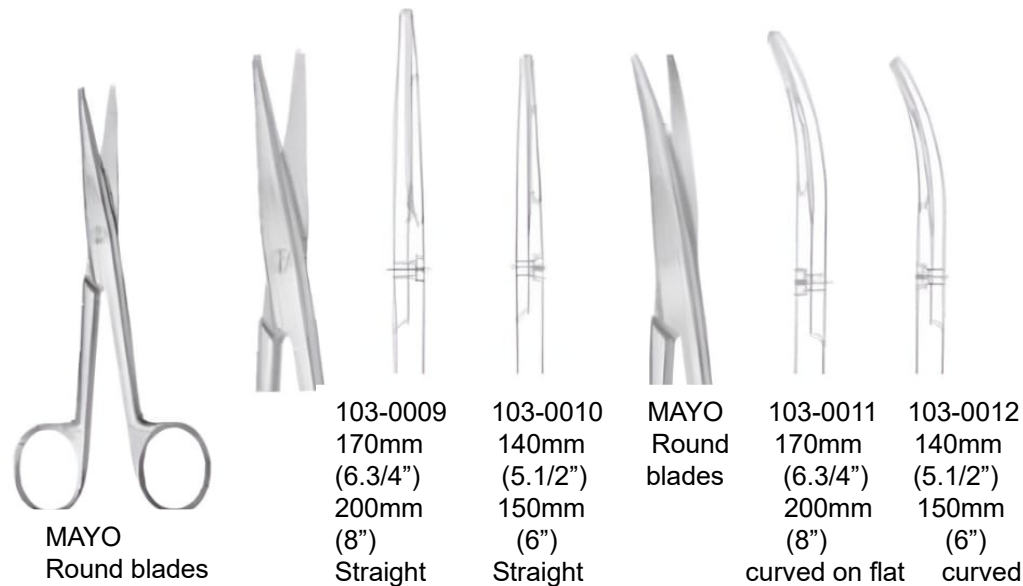

MAYO
Round blades

103-0009 170mm (6.3/4")	103-0010 140mm (5.1/2")	MAYO Round blades	103-0011 170mm (6.3/4")	103-0012 140mm (5.1/2")
200mm (8")	150mm (6")		200mm (8")	150mm (6")
Straight	Straight		curved on flat	curved on flat

SCISSORS

Curved on flat, blunt points

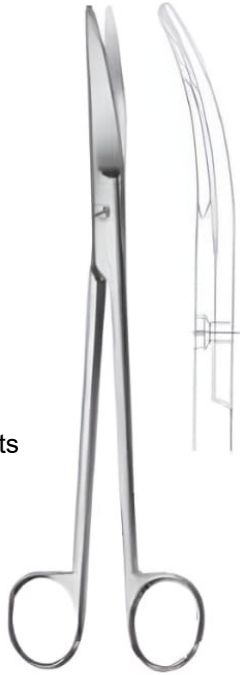

MAYO HARRINGTON
103-0013
225MM(9")

Straight, blunt points



MAYO HARRINGTON
103-0014
225mm (9")



MAYO
(STILLE)



103-0015
170mm
(6.3/4")
Straight

103-0016
150mm
(6")
Straight



103-0017
170mm
(6.3/4")
Curved on flat

103-0018
150mm
(6")
Curved on flat



+923307020002



surgiprove@gmail.com



www.surgiprove.com

SCISSORS



METZENBAUM



METZENBAUM

Straight, blunt points
103-0019 115mm (4.1/2")
103-0020 145mm (5.3/4")
103-0021 180mm (7")
103-0022 220mm (8")

METZENBAUM (NELSON)

Straight
103-0023 230mm (9")
103-0024 250mm (10")



METZENBAUM

Curved on flat, blunt points
103-0025 115mm (4.1/2")
103-0026 145mm (5.3/4")
103-0027 180mm (7")
103-0028 200mm (8")

METZENBAUM (NELSON)

Curved on flat
103-0029 230mm (9")
103-0030 250mm (10")



DRESSING

Straight, blunt/ blunt points
103-0031 125mm (5")
103-0032 145mm (5.3/4")
103-0033 150mm (6")
103-0034 180mm (7")
103-0035 200mm (8")



DRESSING

Straight, sharp/ blunt points
103-0036 125mm (5")
103-0037 145mm (5.3/4")
103-0038 150mm (6")
103-0039 180mm (7")
103-0040 200mm (8")



DRESSING

Straight, Sharp/ Sharp points
103-0041 125mm (5")
103-0042 145mm (5.3/4")
103-0043 150mm (6")
103-0044 180mm (7")
103-0045 200mm (8")



SCISSORS



CRAFOORD
103-0046
305mm (12")
Straight



LLOYD DAVIS RECTAL
blunt points, flat blades
103-0047 255mm(10")
Curved on flat
103-0048 255mm (10")
Straight

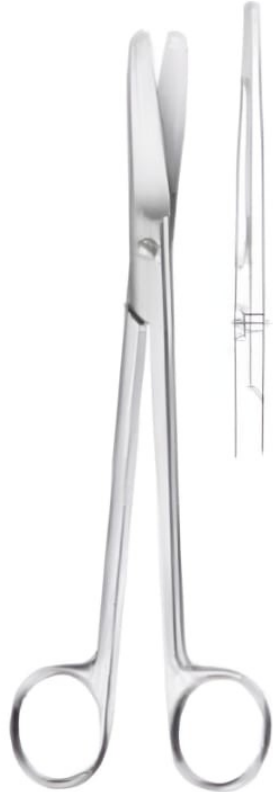

UTERINE
103-0049
230mm(9")
Straight, blunt
points



UTERINE
Curved on flat, blunt points
103-0050 200mm
(8")
103-0051 230mm
(9")

SCISSORS



**BRAUN STADTLER
EPISIOTOMY** angled
Blades.
103-0052
145mm (5.3/4")
103-0053
200mm (8")



**AMERICAN PATTERN
UMBILICAL** angled
Blades.
103-0054
100mm
(4")



HEGEMANN'S DELICATE
190mm (7.1/2")

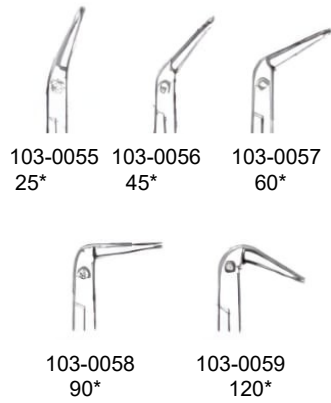

KLINER
103-0060
110mm (4.1/2")
Straight, sharp points
103-0061
110mm (4.1/2")
Curved on flat, blunt
points



AUFRICHT
150mm (6") Light weight
103-0062 Straight
103-0063 curved on flat

DELICATE SCISSORS



IRIS
110mm (4.1/2")
Sharp points

103-0064
Straight
103-0065
curved on flat



IRIS
110mm (4.1/2")
Round blades
Sharp points

103-0066
Straight
103-0067
Curved on flat



IRIS
103-0068 90mm
(3.1/2")
Curved on flat,
lightweight sharp points.



STRABISMUS

103-0069 110mm
(4.1/2") Straight
103-0070 110mm
(4.1/2")
Curved on flat



HEYMAN TURBINECTOMY
103-0071 185MM (7.1/4")
Angled shanks blunt points

DELICATE & ORAL SCISSORS



STEVENS TENOTOMY
110mm (4.1/4")



103-0072
Straight,
Sharp points



103-0073
Curved on flat
Sharp points



103-0074
Straight,
blunt points



103-0075
Curved on flat
blunt points



**SCHUKNECHT
WIRE CUTTING**
103-0076 125mm (5")



WOOD TONSILS
190mm (7.1/2")

103-0077
Curved on flat
sharpened
outer edge, blunt



WHEELER TONSILS
103-0078 250mm (8")
Curved on flat



WILSON TONSIL
103-0079 180mm (7")
Straight

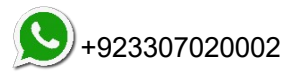

+923307020002



surgiprove@gmail.com



www.surgiprove.com

SCISSORS

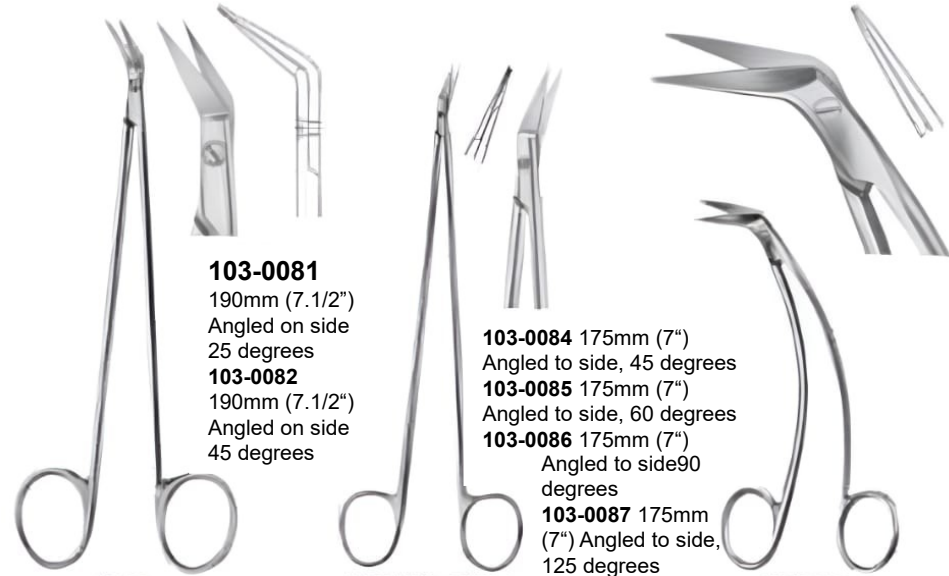

103-0081
190mm (7.1/2")
Angled on side
25 degrees
103-0082
190mm (7.1/2")
Angled on side
45 degrees

103-0084 175mm (7")
Angled to side, 45 degrees
103-0085 175mm (7")
Angled to side, 60 degrees
103-0086 175mm (7")
Angled to side 90
degrees
103-0087 175mm
(7") Angled to side,
125 degrees

FAVALORO 103-0088 150mm (6")
Shanks curved, Blades angled to side

POTTS
103-0080 190mm
(7.1/2")
Angled on flat 45
degrees

HEDGEMAN (DIETRICH)
103-0083 175mm (7")
Angled to side, 25 degrees



DOYEN ABDOMINAL
103-0089 180mm(7")
Curved, blunt points



DOYEN ABDOMINAL
103-0090 180mm(7")
Straight, blunt points



DOYEN ABDOMINAL
103-0091 210mm(8.1/4")
one blade with hook end



COUNTER SCISSORS
103-0092 210mm (8.1/4")

SCISSORS



REYNOLDS
Curved on flat,
tapered points

103-0093 145mm
(5.3/4")
103-0094 180mm
(7")

103-0095 115mm(4.1/2")
103-0096 140mm(5.1/2")
103-0097 180mm (7")
103-0098 200mm (8")
103-0099 235mm (9.1/4")



LISTER BANDAGEz



SCHUMACHER UMBILICAL
103-0100 155mm (6")

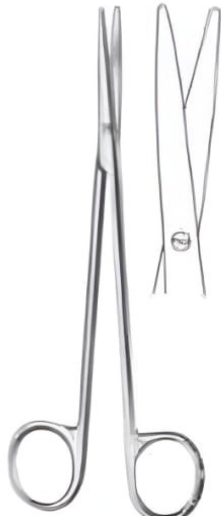

MCINDOE SCISSORS
103-0101 180mm(7")
Straight

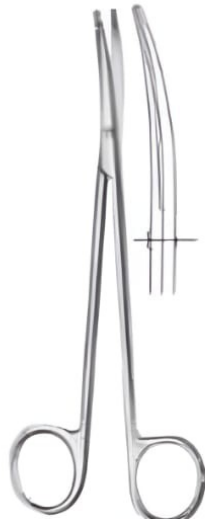

MCINODE SCISSORS
103-0102 180mm(7")
Curved

SERRATED DISSECTING FORCEPS



CANADIAN
straight
104-0001
130mm(5.1/8")
104-0002
150mm (6")



**DISSECTING
FORCEPS**
Turn over end
104-0003 125mm (5")
104-0004 150mm (6")
104-0005 180mm (7")
104-0006 200mm (8")
104-0007 250mm (10")



**DISSECTING
FORCEPS**
Block end
104-0008 125mm(5")
104-0009 150mm(6")
104-0010 180mm(7")
104-0011 200mm(8")
104-0012 250mm(10")



**DISSECTING
FORCEPS**



104-0013
150mm
(6")



104-0014
180mm
(7")



104-0015
200mm
(8")



**DISSECTING
FORCEPS**



104-0016
115mm
(4.1/2")



104-0017
130mm
(5.1/8")



104-0019
160mm
(6.1/4")



**DISSECTING
FORCEPS**
Round points



104-0021
115mm
(4.1/2")



104-0022
130mm
(5.1/8")



104-0023
150mm
(6")



104-0024
160mm
(6.1/4")



104-0025
180mm
(7")



104-0026
200mm
(8")



104-0027
250mm
(10")



104-0028
300mm
(12")

SERRATED DISSECTING FORCEPS



RAMSEY
104-00029
180mm(7")



BONNEY
104-0030
180mm(7")



BICKFORD
104-0031
225mm(9")



MAINGOT
INTESTINAL
Fenestrated grip
104-0032
280mm(11")



ST MARKS
104-0033
290mm(11.1/2")



EMMET
104-00034
200mm(8")

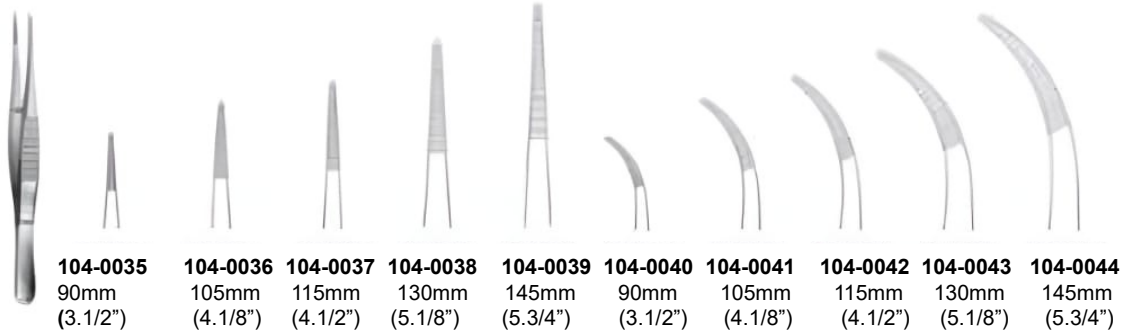

DELICATE DISSECTING FORCEPS

MACINDOE
104-0045
150mm(6")

WAUGH
104-0046
200mm(8")

WAUGH

104-0047
150mm(6")
104-0048
180mm(7")

ADSON

104-0049
125mm(6")
Fine
104-0050
125mm(5")
Standard
104-0051
190mm(7.1/2")

CAIRNS(DOTT)

104-0052
215mm(8.1/2")
Medium jaw
2mm wide

104-0053
180mm(7")
Fine jaw
1mm wide

DELICATE DISSECTING FORCEPS



TREVES
½ teeth

- 104-0054**
125mm(5")
- 104-0055**
150mm(6")
- 104-0056**
180mm(7")
- 104-0057**
200mm(8")
- 104-0058**
250mm(10")



LANE
½ teeth

- 104-0059**
125mm(5")
- 104-0060**
145mm(5.3/4")
- 104-0061**
180mm(7")
- LANE**
2/3 TEETH
- 104-0062**
145mm(5.3/4")
- 104-0063**
180mm(7")



DISSECTING FORCEPS

- 104-0064**
150mm(6") 2/3 teeth
- 104-0065**
150mm(6") ¾ teeth



WAUGH
½ teeth

- 104-0066**
200mm(8")
- 104-0067**
180mm(7")
- 104-0068**
150mm(6")



ADSON
½ teeth

- 104-0069**
125mm(5") Fine
- 104-0070**
125mm(5")
Standard
- 104-0071**
190mm(7.1/2")



ADSON
Bayont
½ teeth

- 104-0072**
190mm
(7.1/2")



JEFFERSON
½ teeth

- 104-0073**
180mm(7")



ADSON-BROWN
7/7 teeth



- 104-0074**
125mm
(5")



PENNYBACKER
¾ teeth
104-0075 160mm(6.1/2")



+923307020002



surgiprove@gmail.com



www.surgiprove.com

TOOTHED DISSECTING FORCEPS

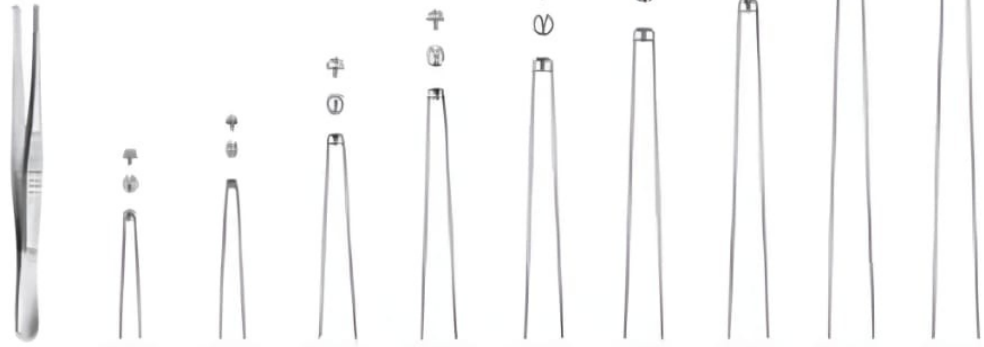

104-0076	104-0077	104-0078	104-0079	104-0080	104-0081	104-0082	104-0083	104-0084
105mm	115mm	130mm	150mm	160mm	180mm	200mm	250mm	300mm
(4.1/8")	(4.1/2")	(5.1/8")	(6")	(6.1/4")	(7")	(8")	(10")	(12")

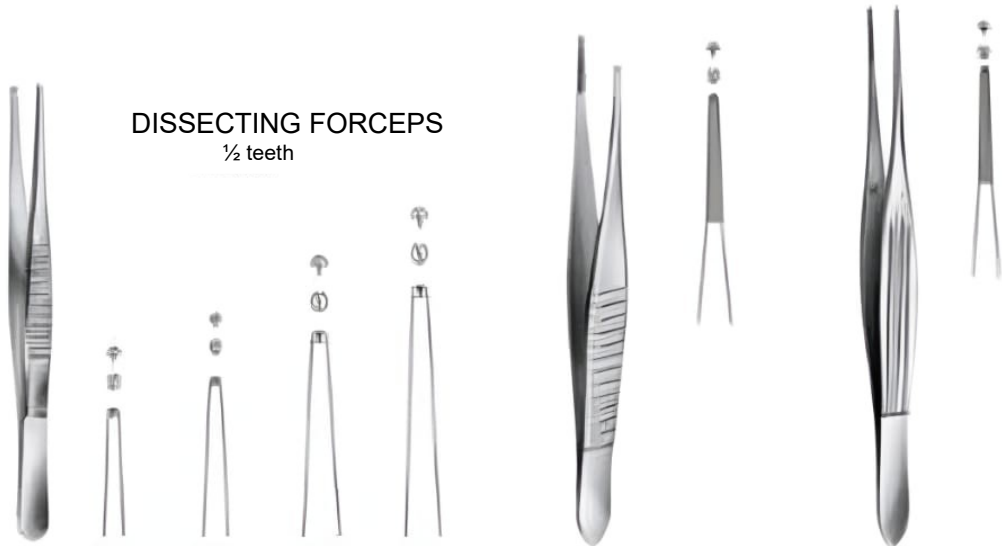

104-0085	104-0086	104-0087	104-0088
115mm	130mm	145mm	160mm
(4.1/2")	(5.1/8")	(5.3/4")	(6.1/4")

GILLIES
104-0089
150mm(6")
1/2 teeth

MICINDOE
104-0090
150mm(6")
1/2 teeth

TOOTHED DISSECTING FORCEPS

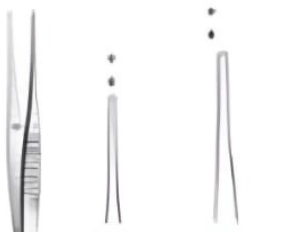

104-0091 104-0094

SILCOCK
½ teeth

104-0092
100mm(4")
104-0093
110mm(4.3/8")

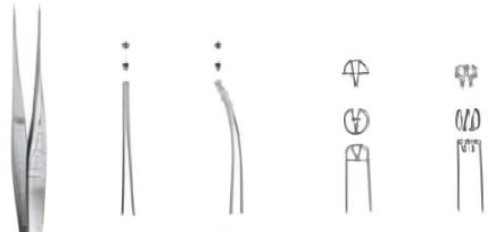

104-0095 104-0098 104-0099 104-0100

FINE
½ teeth
104-0096
100mm(4")
104-0097
100mm(4")



RAMSEY
180mm(7")



BONNY
½ teeth

104-0101
180mm(7")



BICKFORD
½ teeth

104-0102
255mm(9")



CANADIAN
2/3 teeth

104-0103
140mm(5.1/2")

104-0104
150mm(6")

TOOTHED DISSECTING FORCEPS



ST MARKS
1/2 teeth

104-0105
290mm(11.1/2")



**JACKSON
BURROWS**
1/2 teeth

104-0107
140mm(5.1/2")

OFFICER
4/5 teeth

104-0106
150mm(6")



MUSTARDE
Combined, double hooked jaw
104-0108
150mm(6")



RUSSIAN
With circular jaw

104-0109
150mm(6")
104-0110
200mm (8")
104-0111
250mm(10")



**NELSON LUNG
ADHESION**

104-0112
230mm(9")

SPLINTER FORCEPS



**104-0113
ARTHURE**
140mm(5.1/2")



**104-0114
FEILCHENFEL**
70mm(3")
90mm(3.1/2")
115mm(4.1/2")



**104-0115
HUNTER**
105mm
(4.1/8")



**DENIS BROWNE
104-0016**
190mm(7.1/2")



MICRO SOFT TOUCH RING TIP
104-0117
150mm(6")
104-0118
185mm(7.1/4")
104-0119
210mm(8.1/4")
104-0120
230mm(9")
104-0121
250mm(10")



Troeltsch (wild)
104-0122
110mm(4.1/2")



**TUDICHUM
104-0124**
65mm

TROELTSCH(Wilde)
104-0123
120mm(4.3/4")

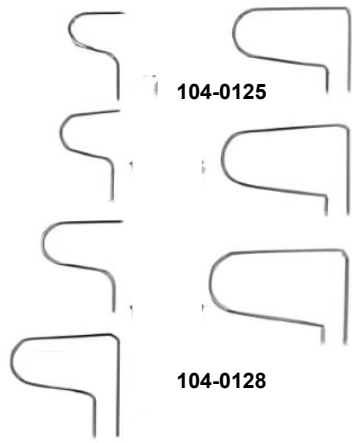

104-0125

104-0126

104-0127

104-0128

DISSECTING & LIGATURE FORCEPS



LIGATURE FORCEPS
105-0001
95mm(3.3/4")
Straight, smooth jaw



MICRO ADSON
105-0002
140mm(5.1/2")

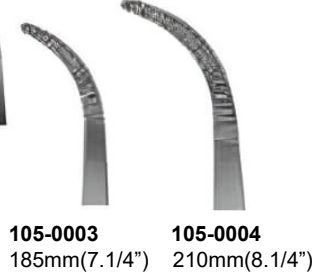

105-0003 185mm(7.1/4")
105-0004 210mm(8.1/4")

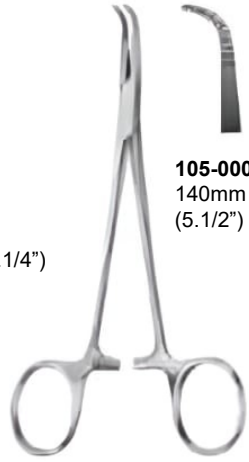

BABY ADSON

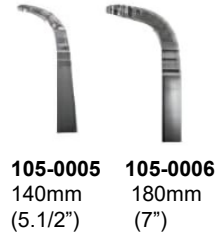

105-0005 140mm
(5.1/2")
105-0006 180mm
(7")



FINE CURVED
DISSECTING FORCEPS

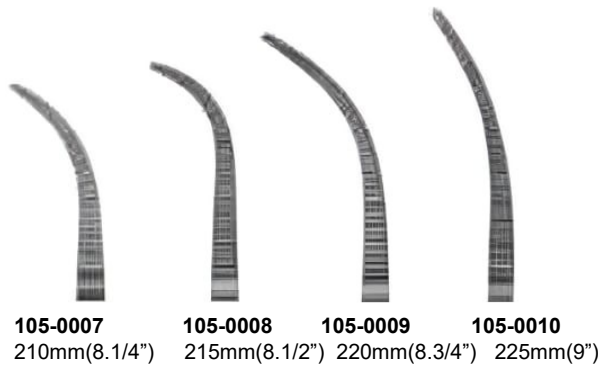

105-0007 210mm(8.1/4")
105-0008 215mm(8.1/2")
105-0009 220mm(8.3/4")
105-0010 225mm(9")

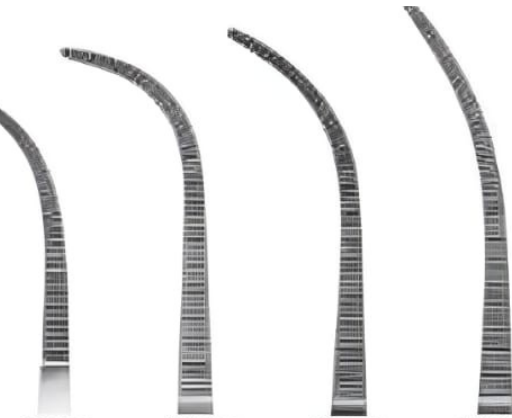

105-0011 225mm(9")
105-0012 295mm(11.3/4")
105-0013 295mm(11.3/4")
105-0014 300mm(12")



S. SHAPED DELICATE

DISSECTING & LIGATURE FORCEPS



MIXTER
105-0015
200mm
(8")



LAWRENCE
105-0016
270mm
(10.3/4")

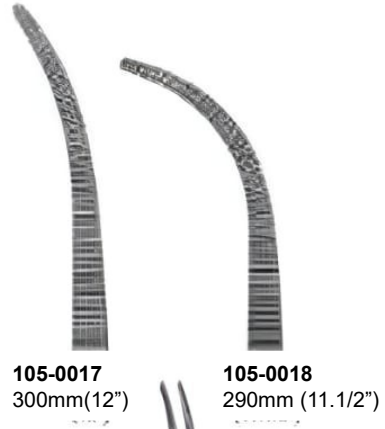

105-0017
300mm(12")

105-0018
290mm (11.1/2")



TISSUE FORCEPS



RUTHERFORD MORISON
105-0019 150mm(6")
 6/7 teeth



STILES(ALLIS-THOMAS)
105-0020 200mm(8")
 6/7 teeth

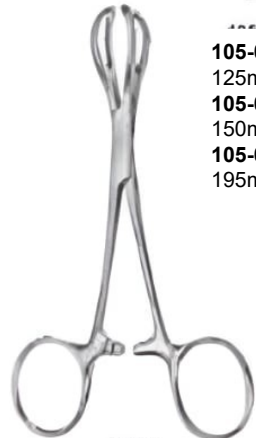

LANE 1/2 teeth fenestrated

105-0021
 125mm(6")
105-0022
 150mm(6")
105-0023
 195mm(7.3/4")



BABCOCK
105-0024 165mm(6.1/2")



BABCOCK 105-0025
 200mm (8") Extra light



BABCOCK
105-0025 230mm(9")

TISSUE FORCEPS



105-0032

105-0033

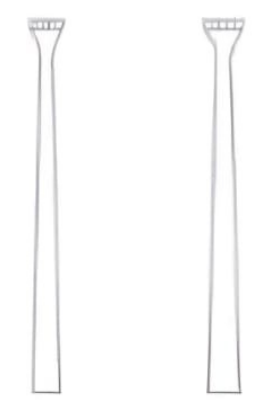

AMERICAN PATTERN ALLIS 105-0034 105mm

ALLIS
150mm (6")
105-0027 2/3 teeth
105-0028 3/4 teeth
105-0029 4/5 teeth
105-0030 5/6 teeth
105-0031 6/7 teeth

JUD-ALLIS
105-0035 195mm
(7.3/4") light
pattern, 3/4 teeth

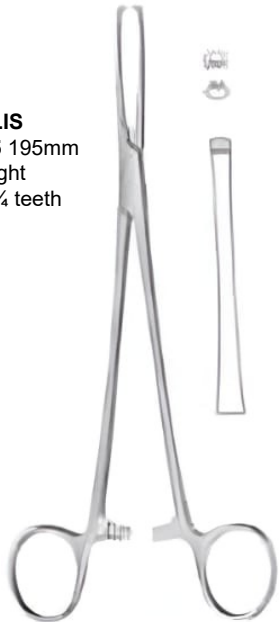

CHAPUT (POIRIER) 105-0036
125mm (5") 2/3 teeth



ALLIS 105-0037
190mm (7.1/2")
105-0038
255mm (10") 5/6 teeth

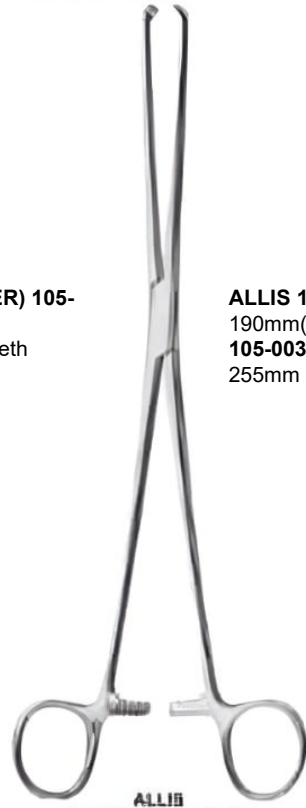

MOUTH GAGS

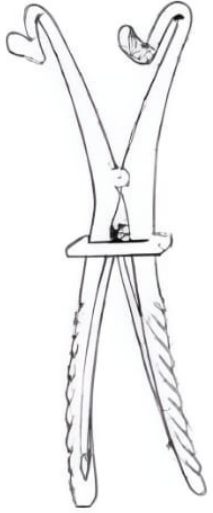

FERGUSSON ACLAND
105-0039
170mm(6.3/4")

105-0040
200mm(8")



DOYEN(CHILD)
105-0041
120mm(4.3/4")



FEATHERSTONE
105-0042
165mm(6.1/2")



DOYEN(ADULT)
105-0043
140mm(5.1/2")



FLAT TONGUE DEPRESSOR
Double ended tapering
19mm+23mm

105-0044
180mm(7")



105-0045
140mm(5.1/2")



LACK TONGUE DEPRESSOR
105-0046 13mm wide child
105-0047 19mm wide Adolescent
105-0048 22mm wide Adults

TONGUE DEPRESSORS

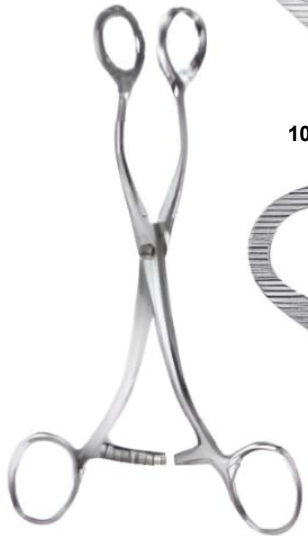

COLIN TONGUE FORCEPS
105-0049 170mm(6.3/4")
105-0050 160mm(6 1/4")



105-0051



105-0052



HEYWOOD-SMITH TONGUE FORCEPS
105-0053 200mm(8")

TOWEL CLAMPS



ROBIN

105-0054 140mm(5, 1/2")
Holder diameter 5mm
105-0055 140mm holder
diameter 13mm **1050056**
140mm holder diameter 25mm



EDNA(LORNA)
105-0057
100mm(4")



EDNA(LORNA)
105-0058
130mm(5. 1/4")



DOYEN
105-0059
190mm(7. 1/2")



BALL AND SOCKET
105-0062 130mm(5")



BACKHAUS

105-0060
90mm(3. 1/2")

105-0061

100mm(4. 3/4")

105-0063



MAYO 105-0064
140mm (5, 1/2")



MOYNIHAN 105-0065
190mm (7. 1/2") 2/2 teeth

SPONGE HOLDING FORCEPS



RAMPLEY

105-0066
180mm(7")

105-0067
240mm (9.1/2")



FORESTER

105-0068
240mm(9.1/2")

105-0069
180mm (7") Straight

105-0070
240mm (9.1/2")

105-0071
180mm (7") Curved
on flat



105-0072



105-0073



105-0074



105-0075

DRESSING FORCEPS



**BOZEMANN UTERINE
DRESSING FORCEPS
105-0076** 255mm(10")
Jaws with longitudinal
groove



BOZEMANN 105-0077
260mm(10.1/4") Serrated
jaws, on large bow



BOZEMANN 105-0078
250mm(10') S-shaped
curve



LISTER-SINUS



105-0079
125mm(5")



105-0080
150mm(6")



105-0081
180mm(7")

HAEMOSTATS FORCEPS



HALSTEAD MOSQUITO
106-0001 100mm(4")
Straight



HALSTEAD MOSQUITO
106-0002 100mm(4")
Curved on flat



HALSTEAD MOSQUITO
100mm(4") ½ teeth
106-0003 Straight
106-0004 Curved on flat



HALSTEAD MOSQUITO
125mm(5")
106-0005 Straight
106-0006 Curved on flat



HALSTEAD MOSQUITO
125mm(5") ½ teeth
106-0007 Straight
106-0008 Curved on flat



BABY-CRILE
106-0009
140mm(5.1/2")
Straight

HAEMOSTATS FORCEPS



BABY-CRILE
106-0010 140mm(5.1/2")
Curved on flat



BABY-CRILE
106-0011 140mm (5.1/2")
Straight 1/2 teeth



BABY-CRILE
106-0012 140mm(5.1/2")
Curved on flat 1/2 teeth



HALSTEAD MOSQUITO
125mm(5")
106-0013 Straight
106-0014 Curved on flat



HALSTEAD MOSQUITO
125mm (5") 1/2 teeth
106-0015 Straight
106-0016 Curved on flat

HAEMOSTATS FORCEPS

106-0017
145mm(5.3/4")
106-0018
180mm(7")



**GREY
TURNER**

106-0019 145mm
(5.3/4")
106-0020 180mm
(7")

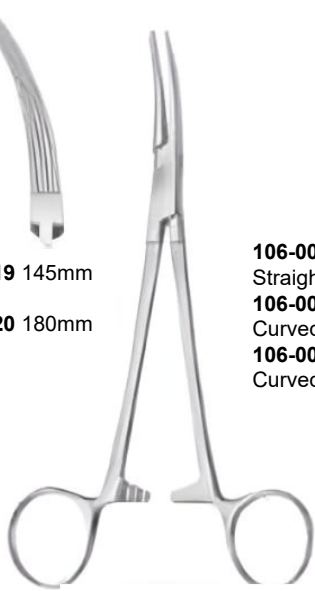

GREY TURNER
Curved on flat

106-0021 145mm(5.3/4")
Straight
106-0022 145mm(5.3/4")
Curved on flat
106-0023 145mm(5.3/4")
Curved to side

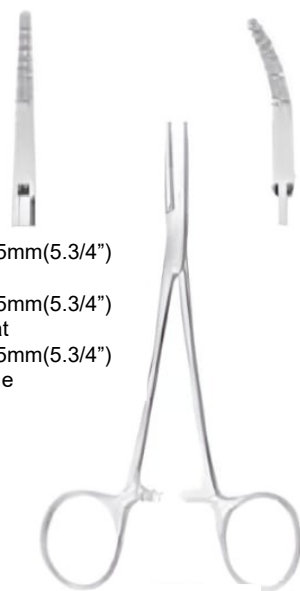

CUSHING

106-0024
254mm(9.3/4")
Curved on flat



CRAFOORD

106-0025
140mm(5.1/2")
106-0026
160mm(6.1/4")
106-0027
180mm (7")

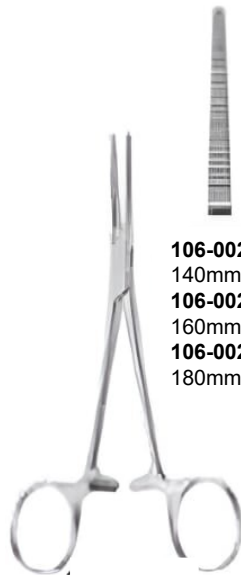

CRILE
Straight

106-0028 145mm(5.3/4")
106-0029 145mm (5.3/4") Curved on flat
106-0030 145mm(5.3/4") Curved to side



CARINS

HAEMOSTATS FORCEPS



CRILE 1/2 teeth **106-0031** 160mm (6.1/4") Straight
106-0032 160mm(6.1/4") Curved on flat
106-0033 140mm (5.1/2") Straight
106-0034 140mm (5.1/2") Curved on flat



CRILE Curved on flat **106-0035**
 140mm (5.1/2")
106-0036 160mm (6.1/4")



KELLY-CRILE straight **106-0037** 140mm (5.1/2")
106-0038 160mm (6.1/4")



KELLY
 Curved on flat
106-0039 140mm (5.1/2")
106-0040 160mm (6.1/4")



KELLY HALSTEAD
106-0041 140mm(5.1/2") Straight
106-0042 140mm (5.1/2") Curved on flat



KOCHER
 Straight 1/2 teeth **106-0043** 125mm (5")
106-0044 140mm (5.1/2")
106-0045 150mm (6")
106-0046 180mm (7")
106-0047 200mm (8")
106-0048 225mm (9")

HAEMOSTATS FORCEPS



KOCHER Curved on flat ½ teeth
106-0049 125mm (5")
106-0050 140mm (5.1/2")
106-0051 150mm (6")
106-0052 180mm (7")
106-0053 200mm (8")
106-0054 225mm (9")

106-0055
 260mm (10.1/4")
 Curved on flat



MAYO
106-0056
 160mm
 Curved
 on flat



**LLOYD
 DAVIS**



ROCHESTER-OSCHNER
 Straight ½ teeth

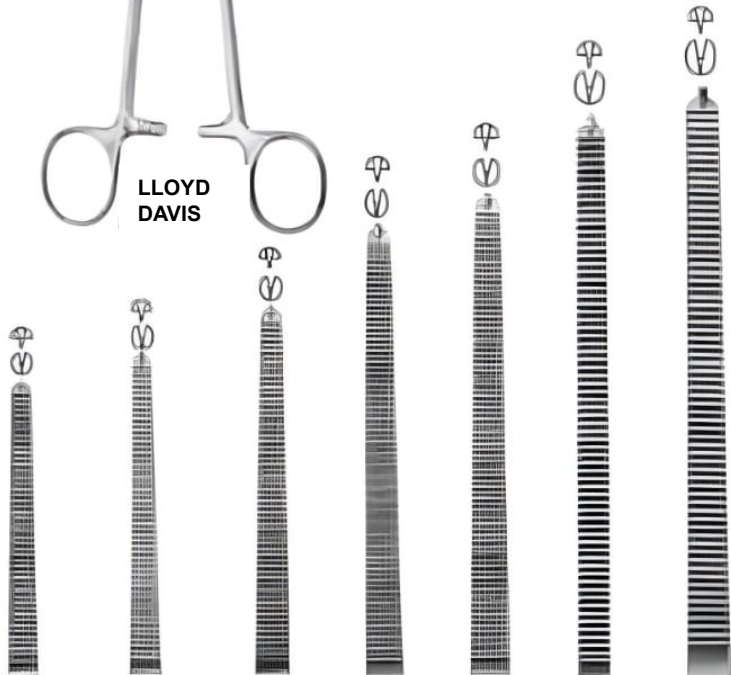

106-0057 140mm(5.1/2") **106-0058** 160mm(6.1/4") **106-0059** 185mm(7.1/4") **106-0060** 200mm(8") **106-0061** 225mm(9") **106-0062** 240mm(9.1/2") **106-0063** 260mm(10.1/4")

HAEMOSTATS FORCEPS



ROCHESTER-OSCHNER
Curved ½ teeth

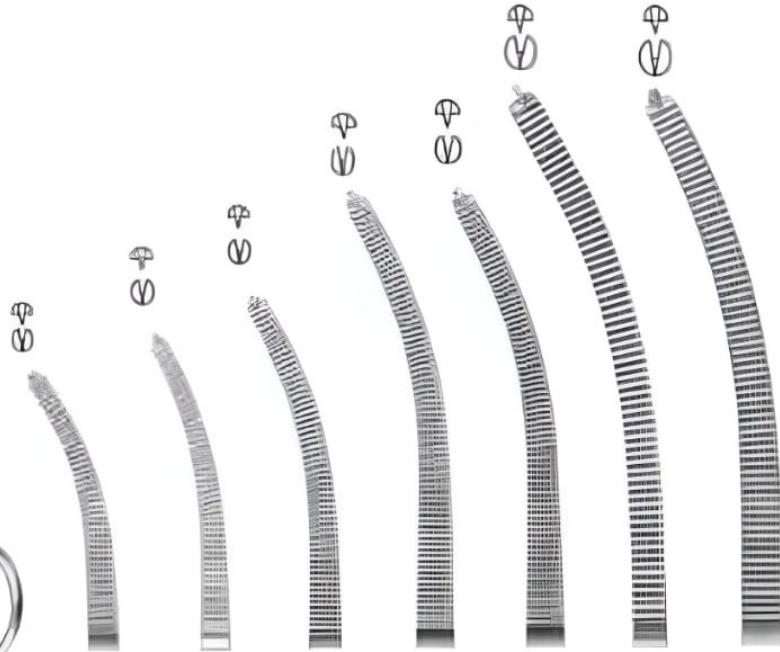

106-0064	106-0065	106-0066	106-0067	106-0068	106-0069	106-0070
140mm (5.1/2")	160mm (6.1/4")	185mm (7.1/4")	200mm (8")	225mm (9")	240mm (9.1/2")	260mm (10.11/4")



FRASER-KELLY(CRILE)
106-0071 180mm(7") Curved on flat

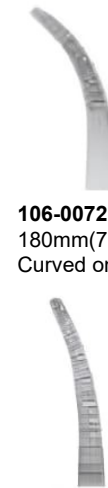

106-0072
180mm(7")
Curved on flat



106-0073
180mm(7")
Straight

106-0074
185mm(7.1/4")
Curved on flat
½ teeth

106-0075
185mm
(7.1/4")
Straight
½ teeth



**FRASER
ADSON**



DUNHILL
106-0076 125mm(5") Curved on flat
106-0077 125mm(5") Straight
106-0078 180mm(7") Curved on flat

HÆMOSTATS FORCEPS



SPENCER WELLS
Straight

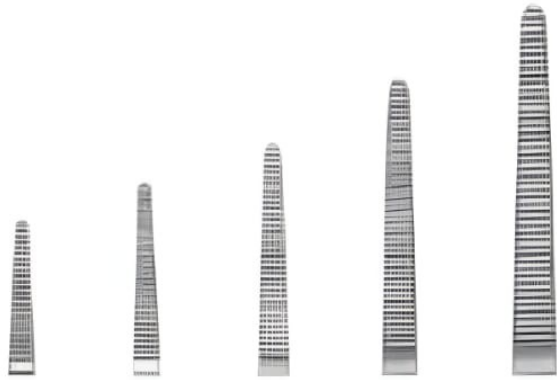

106-0079 125mm (5")	106-0080 150mm (6")	106-0081 180mm (7")	106-0082 200mm (8")	106-0083 225mm (9")
----------------------------------	----------------------------------	----------------------------------	----------------------------------	----------------------------------



106-0084 125mm (5")	106-0085 150mm (6")	106-0086 180mm (7")	106-0087 200mm (8")	106-0088 225mm (9")
----------------------------------	----------------------------------	----------------------------------	----------------------------------	----------------------------------

SPENCER WELLS
Curved on flat

HAEMOSTATS FORCEPS



HEISS 106-0103

200mm(8") Straight

106-0104 200mm(8") Curved on side

106-0105 200mm(8") Straight ½ teeth

106-0106 200mm(8") Curved on flat ½ teeth



ROBERTS Curved on flat

106-0107 230mm(9") Screw joint

106-0108 230mm(9") Box joint



106-0109



MOYNIHAN 106-0109

230mm(9")

106-0110 240mm (9.1/2")

106-0110

MIXTER

Curved on flat



106-0111

140mm(5.1/2")



106-0112

230mm (9")



BIRKETT

106-0114 180mm(7") Straight

106-0115 180mm(7") Curved to side

106-0116 180mm(7") Curved on flat

HAEMOSTATS FORCEPS



ROCHSTER PEAN
Straight

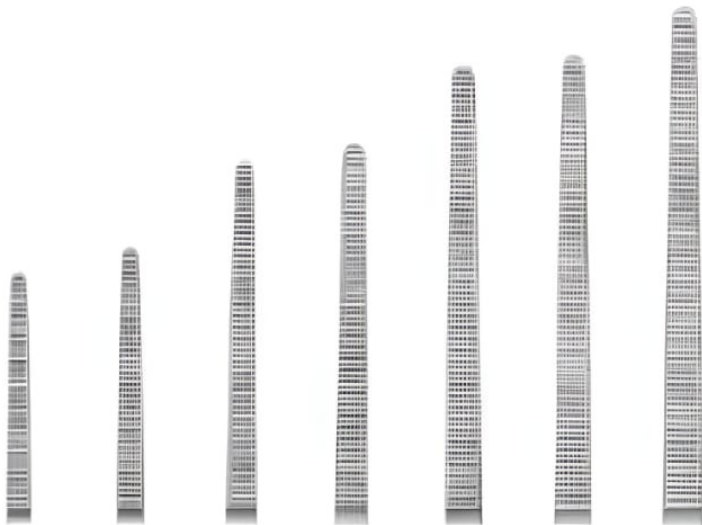

106-0089	106-0090	106-0091	106-0092	106-0093	106-0094	106-0095
140mm	160mm	185mm	200mm	225mm	240mm	260mm
(5.1/2")	(6.1/4")	(7.1/4")	(8")	(9")	(9.1/2")	(10.1/4")



106-0096	106-0097	106-0098	106-0099	106-0100	106-0101	106-0102
140mm	160mm	185mm	200mm	225mm	240mm	260mm
(5.1/2")	(6.1/4")	(7.1/4")	(8")	(9")	(9.1/2")	(10.1/4")

ROCHSTER PEAN
Curved on flat

HÆMOSTATS FORCEPS



- 106-0117**
150mm
(6")
- 106-0118**
180mm
(7")
- 106-0119**
200mm
(8")
- 106-0120**
230mm
(9")
- 106-0121**
255mm
(10")

O'SHAUGHNESSY
Curved, light weight



TUBING CLAMP
Heavy pattern, wedge jaw
106-0122 150mm(6")
106-0123 180mm(7")
106-0124 200mm(8")



- 106-0125**
- 106-0126**

FICKLING ORAL
106-0127
180mm(7") Angled to side ½ teeth
106-0128
180mm (7") Angled to side

TONSILS ARTERY FORCEPS



106-0129



106-0130



SCHNIDT TONSILS
106-0131 180mm(7")
Slight curved on flat



NEGUS TONSILS
106-0132 180mm(7")
small curved
106-0133 180mm(7")
Large Curved



WILSON TONSIL
106-0134 190mm(7.1/2")
Curved on flat
Angled shafts

MICRO NEEDLE HOLDERS



CASTROVIEJO
107-0001
145mm(5.3/4")
With catch



CASTROVIEJO
107-0002
145mm(5.3/4")
with catch



ARRUGA
107-003
135mm(5.1/4")



BARRAQUER
107-0004
120mm(4.3/4")
with catch



BARRAQUER
107-0005
120mm(4.3/4")
without catch



CONVERSE
107-0006



DERF
107-0007



MAYO(DUNHILL)
107-0008



MAYO
107-0009

NEEDLE HOLDER



MAYO 107-0010 190mm
(7.1/2")



**CRILEWOOD
107-0011** 150mm
(6")



CRILE MURRAY 107-0012
145mm(5.3/4")



**KLINER
107-0013** 135mm
(5.1/4")



NAUTAN MORGAN



107-0014
190mm (7.1/2")
107-0015
250mm (10")



WANGENSTEEN



107-0016
270mm (10.3/4")

NEEDLE HOLDER



JAMESON
107-0016
230mm (9")



WRIGHT 107-0017
125mm (5")



GILLIES Combined
needle holder and
scissors **107-0018**
160mm (6.1/4")



WARD Combined
needle holder and
Scissors **107-0019**
180mm (7")



HEANY 107-0020
200mm (8")

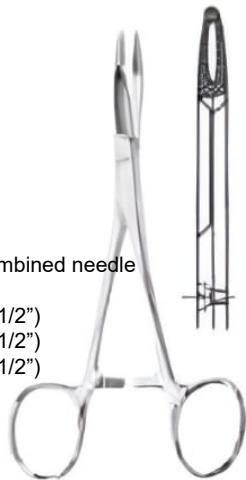

OLSAN HEGAR Combined needle
holder and scissors
107-0021 140mm(5.1/2")
107-0022 165mm(6.1/2")
107-0023 190mm(7.1/2")

NEEDLE HOLDERS



MAYO



MAYO (BAUMGARTNER)
107-0024 140mm(5.1/2")



107-0028
200mm (8")



MAYO(MASSON)
107-0025 265mm(10.1/2")



107-0029
230mm(9")



MAYO
107-0026 165mm(6.1/2")



HEGAR
107-0030
200mm(8")



107-0027
190mm (7.1/2")



HALESY 107-0031 125mm(5")



MATHIEU 107-0032 140mm (5.1/2")

NEEDLE HOLDERS



MATHIEU 107-0033
170mm (6.3/4")



MATHIEU 107-0034
200mm(8")



WEBSTER Smooth jaw 107-0035
115mm(4.1/2")



MAYO 107-0036
150mm(6")



MCPHAILS 107-0037
180mm(7")



LAWRANCE 107-0038
150mm(6") Lightweight
107-0039 150mm(6")

PROBES



BRODIE
107-0040
 200mm(8")
 Ball point



DIRECTORS
107-0041 130mm(5.1/8")
107-0042 145mm(5.3/4")
107-0043 160mm(6.1/4")



107-0044
 140mm(5.1/2")



SINUS
107-0045
 150mm(6")



PROBE
 with eye

- PROBE**
- 107-0046**
127mm(5")
- 107-0047**
152mm(6")
- 107-0048**
178mm(7")
- 107-0049**
200mm(8")
- 107-0050**
255mm(10")
- 107-0051**
305mm(12")



MYRTLE LEAF PROBE
107-0052
 145mm(5.3/4")



1mm Tip
107-0053
 145mm(5.3/4")

- 1.5mm tip**
- 107-0054**
130mm(5.1/8")
- 107-0055**
145mm(5.3/4")
- 107-0056**
160mm(6.1/4")
- 107-0057**
180mm(7")
- 107-0058**
200mm(8")
- 107-0059**
250mm(10")

- 2mm tip**
- 107-0060**
145mm(5.3/4")
- 107-0061**
160mm(6.1/4")
- 107-0062**
180mm(7")
- 107-0063**
200mm(8")

PROBES



LIEBRICH LACHRYMAL
107-0064 No.00_0(0.7-0.8mm)
107-0065 No.1-2(0.9-1.1mm)
107-0066 no.3-4(1.3-1.4mm)
107-067 no.5-6(1.5-1.6mm)



ANEL LACHRYMAL
107-0068
108mm(4.1/4")
0.6mm,small



JOBSON HORNE
107-0069 140mm(5.1/2")
107-0070 178mm (7")



FISTULA PROBE
107-0071 240mm(9.1/2")



KINGS COLLEGE HOSPITAL COCAINISING WIRE
107-0072 89mm (3.1/2")
107-0073 133mm (5.1/4")



LOGAN TUNER
107-0074 120mm
(4.3/4") 1.00mm
diameter



CAWTHRONE
107-0075 140mm
(5.1/2")

DISSECTORS



MZCDONALD 107-0076
185mm(7.1/4") Double
end



WATSON CHEYNE
Fine with probe **107-
0077**125mm(5")
107-0078 190mm (7.1/2")



KOCHER THYROID 107-0079 150mm (6")
107-0080 170mm (6.3/4")



KOCHER THYROID
107-0083 190mm(7.1/2")



KING
107-0084 195mm(7.3/4")



KING
107-0085 200mm (8")

DISSECTORS, SUTURE INSTRUMENTS



PAYR 107-0086
225mm (9")



PAYR 107-0087
280mm(11")



GWYNNE EVANS TONSILS 200mm(8")
Double ended **107-0088** 6mm wide
107-0089 8mm wide



LITTAUER 107-0090
110mm(4.1/2") with hook
End



LITTAUER(SPENCER)
107-0091 80mm (3.1/2")
with hook end

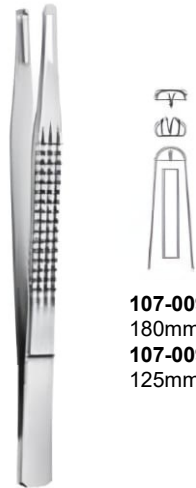

**CHARNLEY SUTURE
FORCEPS**



107-0092
180mm(7")
107-0093
125mm (5")

HAND HELD RETRACTORS



DEAVER 108-0001
15mm(8.1/2")
Blade: 22mm wide

DEAVER 108-0002
300mm(12")
Blade:25mm wide

DEAVER 108-0003
315mm(12.1/2")
Blade:25mm wide

DEAVER 108-0004
300mm (12")
Blade:38mm wide

DEAVER 108-0005
300mm(12.1/4")
Blade: 50mm wide

HAND HELD RETRACTORS



**DEAVER GRIP
NO.1 108-0006**
310mm(12.1/4")
Blade:25mm wide

**DEAVER GRIP
NO.2 108-0007**
310mm(12.1/4")
Blade:38mm wide

**DEAVER GRIP
NO.3 108-0008**
302mm(12")
Blade:50mm wide

**DEAVER GRIP
NO.4 108-0009**
310mm(12.1/4")
Blade:75mm wide

HAND HELD RETRACTORS



RICHARDSON
240mm(9.1/2")



108-0010 Blade:
23mm/20mm



108-0011 Blade:
30mm/29mm

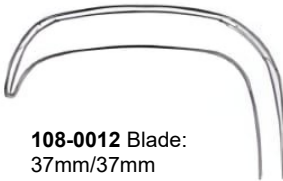

108-0012 Blade:
37mm/37mm

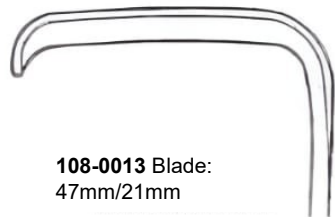

108-0013 Blade:
47mm/21mm

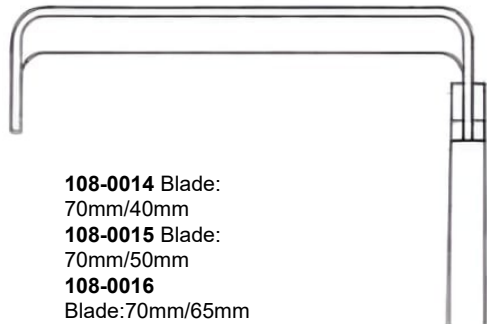

108-0014 Blade:
70mm/40mm
108-0015 Blade:
70mm/50mm
108-0016
Blade:70mm/65mm



MORRIS 245mm
(9.3/4") Single
blade

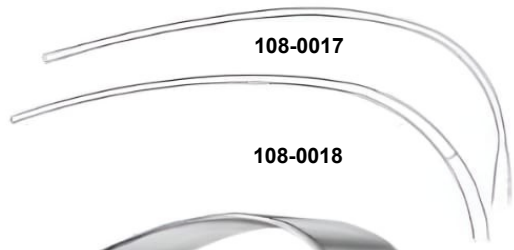

108-0017

108-0018



KELLY 108-0019
260mm (10.1/4")
Blade: 150mm/39mm

108-0020 260mm
(10.1/4") Blade:
150m/57mm

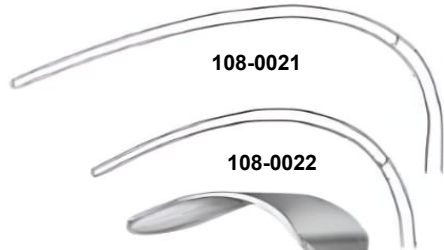

108-0021

108-0022



LIVER RETRACTORS
250mm (10") **108-0022**
Blade: 91mm/35mm
108-0021 Blade:
121mm/50mm

HAND HELD RETRACTORS

HAND HELD RETRACTORS



108-0023 220mm
(8.3/4") blade:
15mm/15mm

108-0024 215mm
(8.1/2")Blade:
20mm/22mm

108-0025
B235mm (9.1/4")
Blade:
28mm/28mm

DURHAM 215mm
(8.1/2") **108-0026**
Blade:10mm **108-0027**
Blade:16mm

MIDDELDORPF

108-0031

108-0032

KOCHER 108-0028
230mm(9")
Blade:36mm/20mm

MOYNIHAN 205mm(8")
108-0029 Blade: 20mm/15mm
108-0030 Blade: 20mm/12mm

HAND HELD RETRACTORS



108-0033 Blade:
25mm/6mm

108-0034 Blade:
35mm/8mm

108-0035 Blade:
35mm/11mm

108-0036 Blade:
35mm/15mm

108-0037 Blade:
41mm/11mm

108-0038 Blade:
55mm/11mm

108-0039 Blade:
70mm/14mm

108-0038
Blade:55mm/11mm

LANGENBECK
215mm(8.1/2")



KOCHER
108-0041 250mm(10")
Blade:67mm/25mm



CUSHINGS VEIN RETRACTORS
250mm (10")



108-0042 Blade;
14mm/11mm



108-0043 Blade: 18mm/13mm



108-0044 Blade: 22mm/15mm

HAND HELD RETRACTORS



SIMON 108-0056
220mm (8.3/4")



Doyen 108-0057
250mm (10") Blade:
53mm/80mm

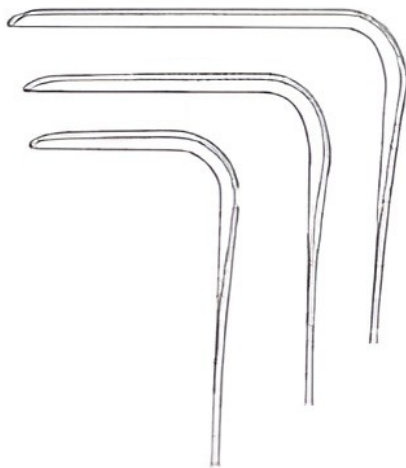

DOYEN 240MM (9.1/2")
108-0058 Blade: 60mm/45mm
108-0059 Blade: 90mm/45mm
108-0060 Blade: 120mm/45mm



HAND HELD RETRACTORS



**LANGENBECK
BONE HOOK
108-0061**
205mm(8")
Sharp



**LANGENBECK
BONE HOOK
108-0062**
205mm(8") Blunt



**KOCHER BONE
HOOK 108-0063**
220mm(8.3/4")
Sharp



**KOCHER BONE HOOK
108-0064** 220mm (8.3/4")
Blunt



108-0065
2 prong, sharp



108-0066
2 prong, blunt



108-0067
3prong, sharp



108-0068
3prong, blunt



108-0069
4prong, sharp



108-0070
4prong, blunt



108-0071
125mm(5")



108-0072
135mm(5.1/4")



108-0073
130mm(5.1/8")



KLINER
150mm (6")

108-0074
Sharp

108-0075
Blunt

RETRACTOR
155mm (6")
Flexible shaft

RETRACTORS

HAND HELD RETRACTORS



RICARD 108-0076

Lateral blades: 58mm/80mm
Centre blade: 54mm/70mm

108-0077

Lateral blades: 72mm/84mm
Centre blade: 72mm/90mm

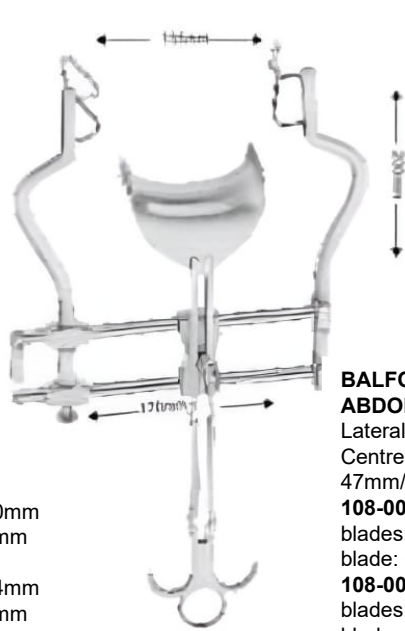

**BALFOUR
ABDOMINAL 108-0078**

Lateral blades: 60mm
Centre blade:
47mm/80mm

108-0079 lateral
blades:60mm Centre
blade: 62mm/76mm

108-0080 Lateral
blades:90mm Centre
blade: 80mm/80mm

108-0081 Lateral
blades: 105mm Centre
blade: 59mm/107mm

KIRSCHNER RETRACTOR SET 108-0082

Set comprising of:
1/ 108-0083
2/108-0084
2/108-0085

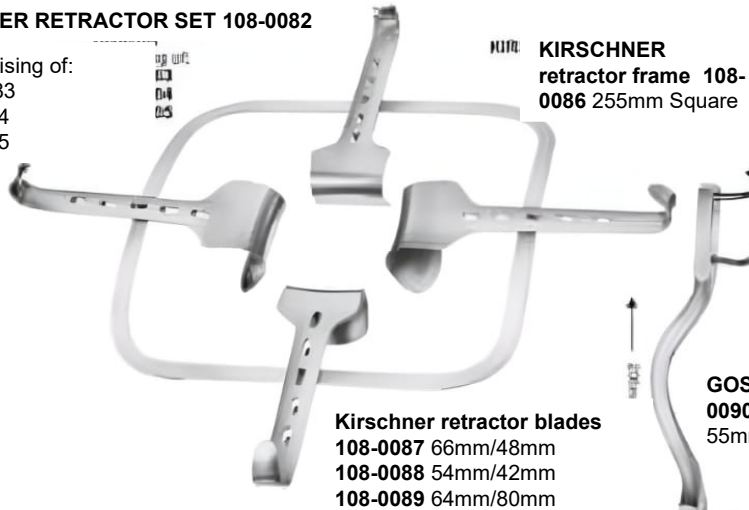

**KIRSCHNER
retractor frame 108-
0086 255mm Square**

Kirschner retractor blades

108-0087 66mm/48mm
108-0088 54mm/42mm
108-0089 64mm/80mm

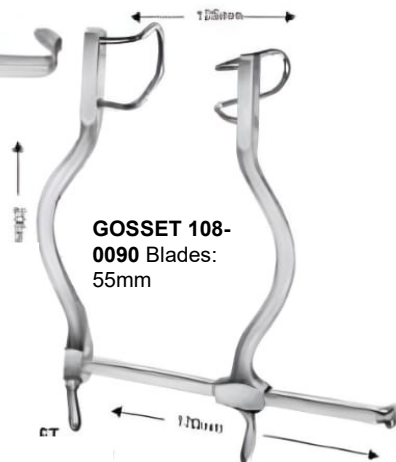

**GOSSET 108-
0090** Blades:
55mm

HAND HELD RETRACTORS



GOLIGHER 108-0091

Complete with two center
Blades: 51mm deep, and four
Lateral blades
2/51mm deep
2/102mm deep



Berkeley abdominal 108-0092

Blades:
35mm/60mm



**TRAVERS
108-0093**
200mm(8")
4/5 teeth
blunt



**IRWIN
108-0094**
178mm(7")
4/5 teeth
Sharp

HAND HELD RETRACTORS



WEISLANDER 108-0095
110mm (4.3/8") 2/3 teeth
Sharp



WEISLANDER 108-0096 110mm
(4.3/8") 2/3 teeth blunt



RNTNE HOSPITAL 108-0097 159mm (6.1/4") 3/4
teeth



NORFOLK AND NORWICH 108-0098 215mm (8.1/2") 4/5
teeth, blunt



WEISLANDER
3/4 teeth, blunt
108-0099 130mm(5.1/8")
108-0100 156mm(6.1/2")



WEISLANDER
3/4 teeth, Sharp
108-0101 130mm(5.1/8")
108-0102 165mm(6.1/2")



WEISLANDER
3/4 teeth, semi sharp
108-0103 130mm (5.1/8")
108-0104 165mm(6.1/2")

HAND HELD RETRACTORS



WEISLANDER

108-0105
195mm(7.3/4")
3/4 teeth Sharp



108-0108
195mm (7.3/4")
3/4 teeth Blunt



108-0106
240mm(9.1/2")
3/4 teeth Sharp



108-0109
240mm(9.1/2")
3/4 blunt



108-0107
255mm(10")
5/6 teeth Sharp



108-0110
255mm(10")
5/6 blunt



CONE 108-0111
145mm (5.3/4")



JANSON (SHEA) 108-0112
105mm (4.1/8")



JEFFERSON
140mm(5.1/2")

CHOLECYSTECTOMY & GALLSTONE



GEARY GRANT
109-0001 230mm
(9") Large curved



LAHEY
109-0002
195mm (7.3/4")
109-0003
230mm (9")



LOWER
109-0004
180mm
(7")



MIXTER
109-0005
220mm (8.3/4")
109-0006
250mm (10")

INTESTINAL CLAMPS



109-0011
Straight



1090012
Curved

DOYEN
165mm
(6.1/2")
Spring
blades



109-0015
Straight



109-0016
Curved

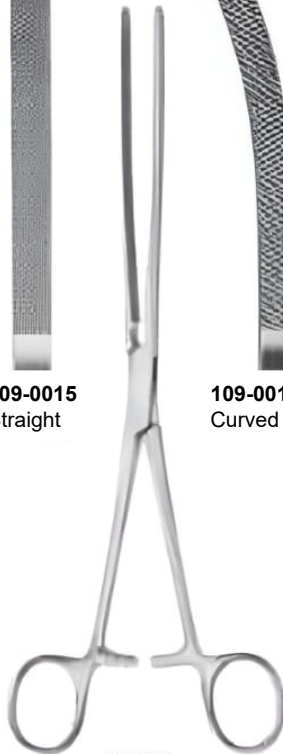

DOYEN
235mm
(9.3/4) spring
blades



109-0013
Straight



109-0014
Curved



DOYEN
235mm(9.3/4")
Spring blades



DOYEN
170mm
(6.3/4")

INTESTINAL CLAMPS



DOYEN(KOCHER)
Straight, light spring blade
109-0019 230mm(9")

109-0021
290mm (11")
109-0022
290mm (11.4")



DOYEN(MAYO ROBSON)
curved, light spring blade
109-0023 230mm(9")

109-0025
290mm (11")
109-0026
290mm (11.4")



KOCHER
Spring blade
109-0027
290mm (11")
109-0028
290mm (11")

INTESTINAL CLAMPS



LANE 109-0029
210mm(8.1/4")



**SETON PRINGLE
(BAINBRIDGE)**
109-0030 150mm (6")
Straight **109-0031**
150mm (6") Curved



DOYEN (MAYO ROBSON)
Spring blades **109-0032**
255mm(10") **109-0033**
280mm (11")

INTESTINAL CLAMPS



SCHOEMAKER
Hollow blades for hemisphincterectomy
109-0034 170mm (6.3/4")
1009-0035 215mm (8.1/2")

PARKER KERR
Anastomosis forceps for colon
resection
109-0036 250mm (10")

LANG STEVENSON
109-0037
200mm (8")

PAYR 109-0038
200mm (8") JAW: 65mm
109-0039 280mm (11")
JAW: 100mm
109-0040 350mm (14")
JAW: 150mm

INTESTINAL CLAMPS



LAWN TWIN ANASTOMOSIS
109-0041 300mm (12")
Curved



LAWN TWIN ANASTOMOSIS
109-0042 300mm (12")
Straight



CUSCO 110-0001
75mm/17mm Extra
small for virgins



GRAVE 110-0004
75mm/20mm
110-0005 95mm/30mm
110-0006 195mm/33mm



McGEE Lateral VAGINAL RETRACTOR
With ratch handle **110-0003**



CUSCO 110-0002
75mm/17mm Extra
small virgins



PBDOLBON
110-0010 103mm a 22mm
110-0011 120mm a 25mm



CUSCO
110-0007 110mm a 27mm
110-0008 80mm a 22mm
110-0009 80mm a 24mm

VAGINAL SPECULUM

SIMS 111-0001
 125mm (5") Small
 70mm/26mm
 75mm/30mm
111-0002 150mm(6")
 Medium
 75mm/30mm
 80mm/35mm
111-0003 175mm(7")
 Large 80mm/36mm
 90mm/40mm

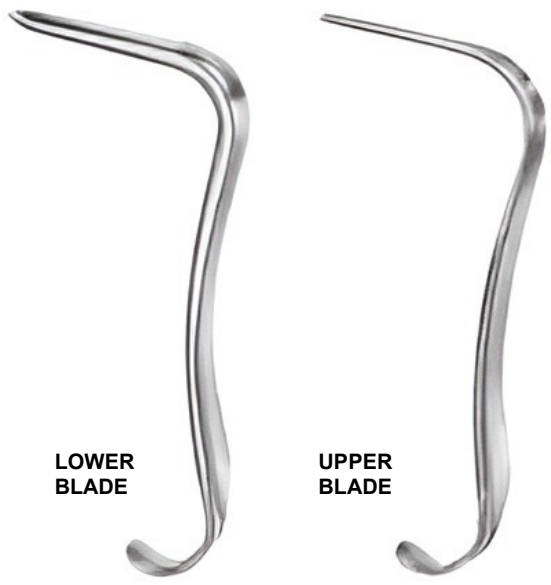

**LOWER
 BLADE**

**UPPER
 BLADE**

111-0004
 175mm(7")
 Blade:
 70mm/15mm



111-0008
 175mm (7")
 Blade:
 70mm/10mm



111-0005
 180mm(7")
 Blade:
 70mm/27mm



111-0009
 180mm(7")
 Blade:
 75mm/23mm



111-0006
 180mm(7")
 Blade:
 75mm/30mm



111-0010
 180mm (7")
 Blade:
 80mm/25mm



111-0011
 185mm
 (7.1/4") Blade:
 100mm/32mm



111-0007
 185mm
 (7.1/4") Blade:
 90mm/36mm



KRISTELLE

KRISTELLE

VAGINAL SPECULUM

MATHIEU 111-0012
210mm (8.1/4")
Blade: 95mm/17-
30mm
For children and
virgins



DOYEN 240mm (9.1/2")
111-0013 Blade:
60mm/35mm

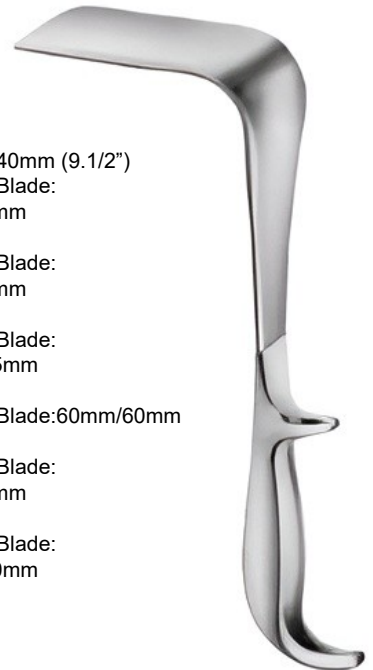

111-0014 Blade:
90mm/35mm

111-0015 Blade:
120mm/35mm

111-0016 Blade:60mm/60mm

111-0017 Blade:
90mm/60mm

111-0018 Blade:
120mm/60mm

MODIFIED WERTHEIM
320mm (1.23/4")

111-0019 Blade:
100mm/25mm

111-0020 Blade:
100mm/30mm

111-0021 Blade:
100mm/35mm

111-0022 Blade:
100mm/40mm

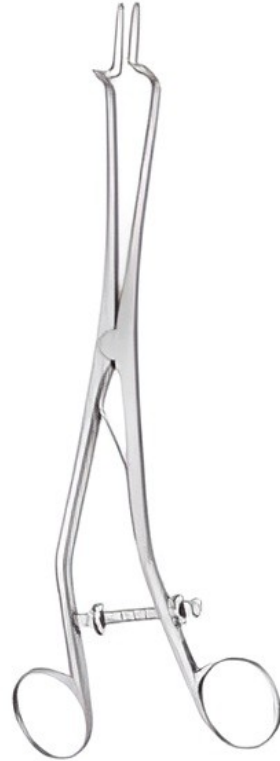

KOGAN ENDOCERVICAL SPECULUM

111-0023
240mm (9.1/2")
Graduated

VAGINAL SPECULUM

VAGINAL RETRACTOR/ UTERINE DILATORS



AUVARD 111-0024
230mm (9") Blade:
63mm/38-28mm
Weight: 1.53kg (3lb, 60z)
Fixed weight

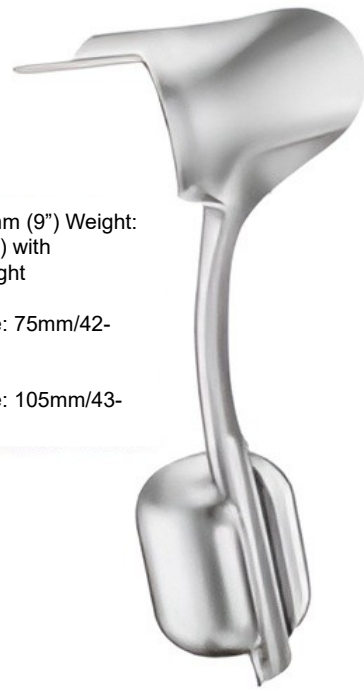

AUVARD 230mm (9") Weight:
1.47kg (3lb,4oz) with
detachable weight

111-0025 Blade: 75mm/42-
40mm

111-0026 Blade: 105mm/43-
40mm



O6-09443
Set of twelve

- 111-0027 6mm
- 111-0028 7mm
- 111-0029 8mm
- 111-0030 9mm
- 111-0031 10mm
- 111-0032 11mm
- 111-0033 12mm
- 111-0034 13mm
- 111-0035 14mm
- 111-0036 15mm
- 111-037 16mm
- 111-038 17mm

HAWKIN AMBLER
170mm(6.3/4")
Cervix dilator



HOGAR
105mm (7.1/4")
Cervix dilator

111-0039
Set of sixteen
Consisting of one of
Each of: 111-0040 to 111-0056

111-0040	2mm	111-0052	12mm	111-0063	8.5mm
111-0041	3mm	111-0053	14mm	111-0064	9.5mm
111-0042	4mm	111-0054	15mm	111-0065	10.5mm
111-0043	5mm	111-0055	16mm	111-0066	11.5mm
111-0044	6mm	111-0056	17mm	111-0067	12.5mm
111-0045	7mm	111-0057	2.5mm	111-0068	13.5mm
111-0046	8mm	111-0058	3.5mm	111-0069	14.5mm
111-0047	9mm	111-0059	4.5mm	111-0070	15.5mm
111-0048	10mm	111-0060	5.5mm	111-0071	16.5mm
111-0049	11mm	111-0061	6.5mm	111-0072	17.5mm
111-0050	12mm	111-0062	7.5mm		

UTERINE DILATORS/ PROBES



HEGAR 205mm
(8") Cervix dilator
double ended

111-0073 Set of eight
consisting of one of
each of : 111-0074 to
111-0082

- 111-0074** 1mm-2mm
- 111-0075** 3mm-4mm
- 111-0076** 5mm-6mm
- 111-0077** 7mm-8mm
- 111-0078** 9mm-10mm
- 111-0079** 11mm-12mm
- 111-0080** 13mm-14mm
- 111-0081** 15mm-16mm
- 111-0082** 17mm-18mm



GALABIN 111-0083
290mm (11.1/2")
Shaft graduated
15 cm's Malleable



SIMS 111-0084
330mm (13")
111-0085
330mm (13")
Malleable



MARTIN 111-0086
330mm (12")

UTERINE DILATORS COMPLETE SETS



111-0087 HEGAR Dilator set consisting of: 14 dilators, 1 Rack for dilators (4-12mm) 1 Rack for dilators (13-17mm) 1 Metal case only, with hinged lid, stainless 200/100/35 mm



...
111-0088 HEGAR Dilator set consisting of: 26 dilators, 1 Rack for dilators (1-17mm) 1 Rack for dilators (18-26mm) 1 Metal case only, with hinged lid, Aluminium 330/220/80 mm

TENACULUM FORCEPS



BROWN
112-0001
250mm (10")
Standard



SCHROEDER
112-0002
230mm (9")



WILBON
112-0003
240mm (9.1/2")

OVUM FORCEPS



HEYWOOD SMITH
112-0004
240mm (9.1/2")



MCLINTOCK
112-0005
240mm(9.1/2")



NOTO
112-0006
280mm (11")

OVUM FORCEPS



DOYEN
112-0007
105mm (7.1/4")



112-0008
250mm (10")



BONNEY POLYPI
112-0009
240mm (9.1/2")

CERVICAL BIOPSY FORCEPS

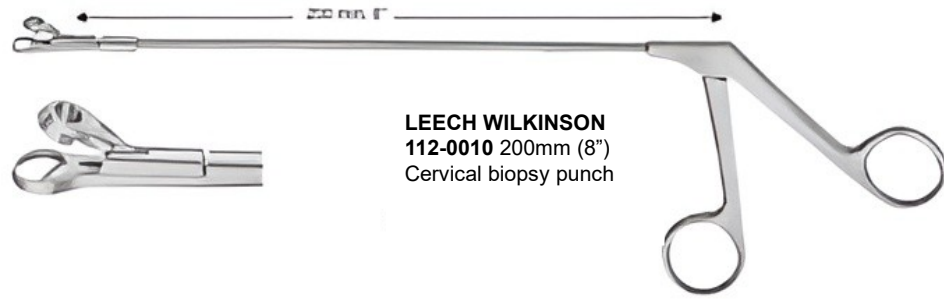

LEECH WILKINSON
112-0010 200mm (8")
Cervical biopsy punch

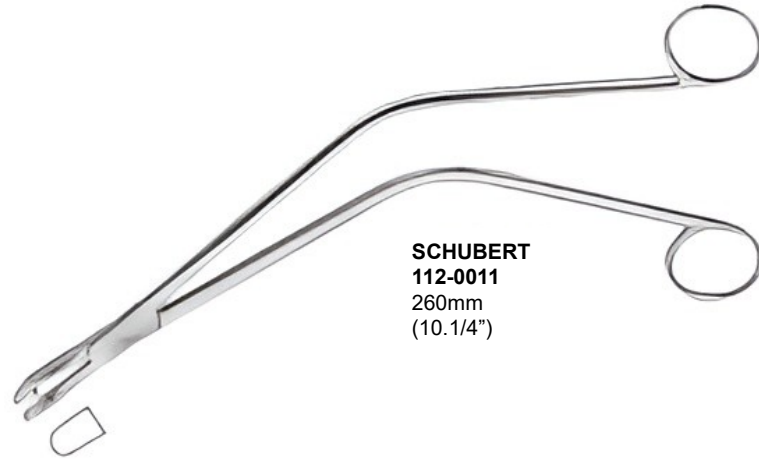

SCHUBERT
112-0011
260mm
(10.1/4")

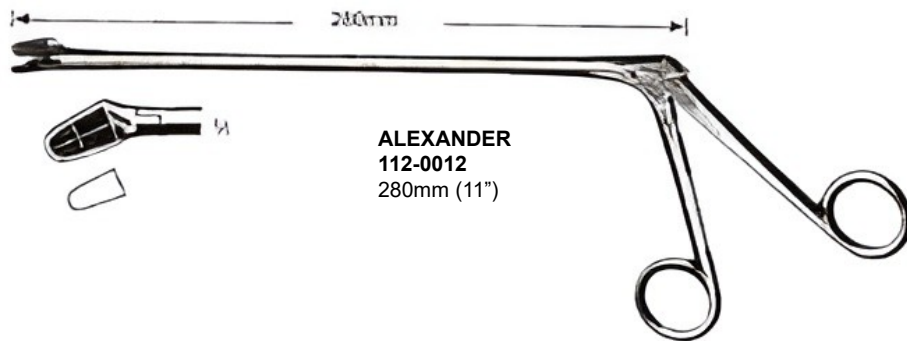

ALEXANDER
112-0012
280mm (11")

CERVICAL BIOPSY FORCEPS

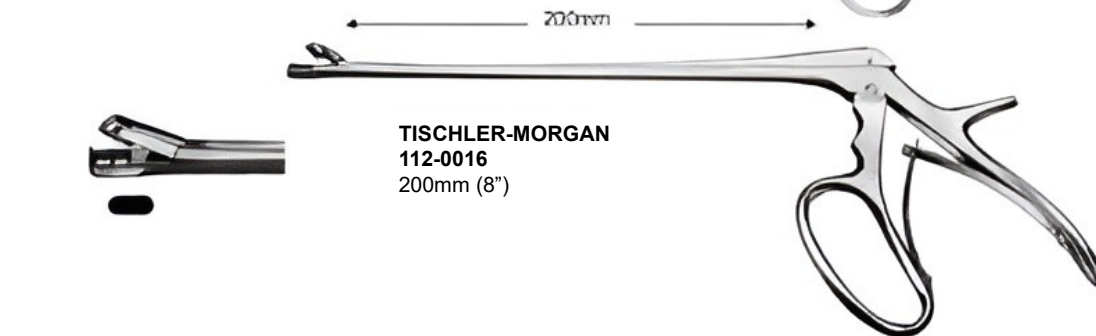
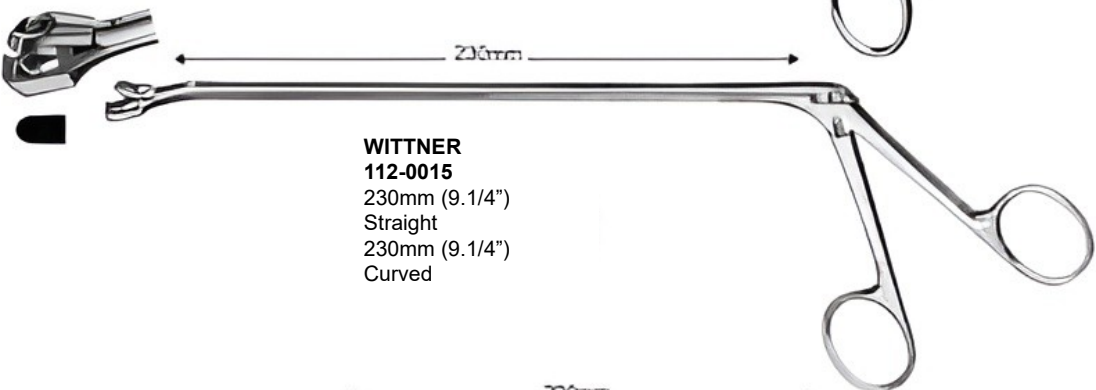
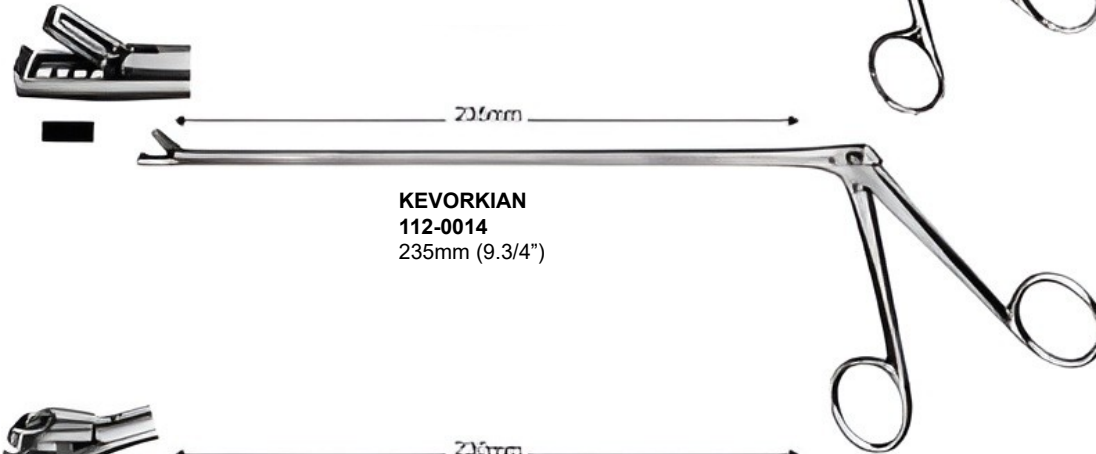
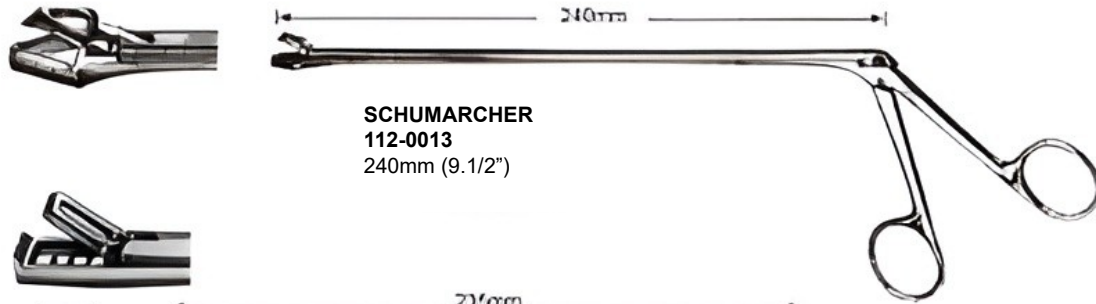

UTERINE SCOOPS & CURETTES

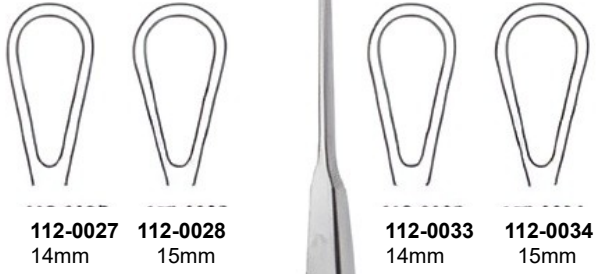
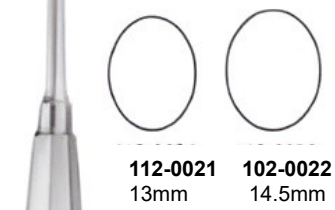
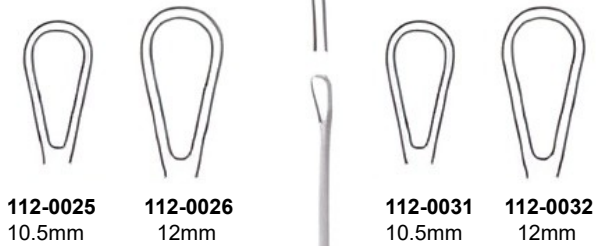
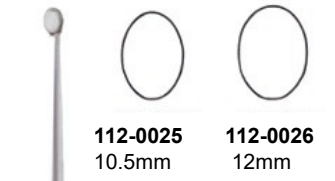
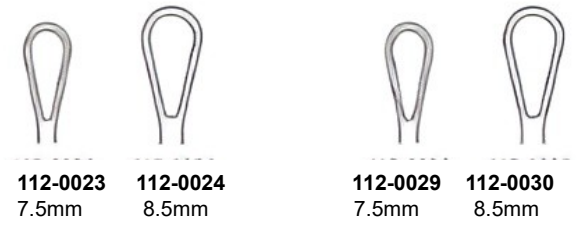

SIMON
240mm (9.1/2")

SIMS
255mm (10")
Rigid, sharp

SIMS
255mm (10")
Malleable, sharp

UTERINE CANNULAE



SIMS
112-0053
280mm (11")



RECAMIER
112-0054
310mm (13")



BUMM
112-0055
280mm (11")

OBSTETRICS INSTRUMENTS



SIMPSON
112-0056 300mm
(12")



SIMPSON-BRAUN
112-0057 330mm
(13")



DeLEE
112-0058 300mm
(12")



DeLEE
112-0059 360mm (14.1/2")



ELLIOT
112-0060 320mm (12.1/2")



NAEGELE 112-0061
360mm (14.1/2")



I.U.D.REMOVING HOOK 112-0062
320mm (12.1/2")



WRIGLEY 112-0063
250mm (10")



KIELLAND 112-0064
402mm (16.3/4")

OBSTETRICS INSTRUMENTS



LUIKART
112-0065
400mm (16")



KELLAND-LUIKART
112-0066 400mm (16")



SIMPSON-LUIKART
112-0067 360mm (14.1/2")



McLEAN-TURKER-LUIKART
112-0068 400mm (16")



McLEAN-TUCKER
112-0069
390mm 915.1/2")



McLEAN-LUIKART
112-0070
390mm (15.1/2")



McLEAN
112-0071
360mm (14.1/2")



BARTON
112-0072
360mm (14.1/2")



BARTON
112-0073
170mm (6.3/4")

DERMATOLOGY, GYNECOLOGY INSTRUMENTS



**GREEN-ARMYTAGE
HEAMOSTASIS FORCEPS 113-
0001 200mm (8") Straight
113-0002 195mm (7.3/4") Angled**



**WINTER OVUM FORCEPS
200mm (11.1/2")**



113-0003 113-0004 113-0005



**SAENGER OVUM FORCEPS
113-0006 275MM (10.3/4")**



**UMBILICAL DILATOR
113-0007 95mm (3.3/4")**



13-0008

113-0009

MIKULICZ 113-0008 180mm (7")
113-0009 205mm (8")



113-0010

113-0011

PEROTONEUM 113-0010 205mm(8")
113-0011 205mm (8")



113-0012

113-0013

FAURE 112-0012 205mm(8")
113-0013 205mm (8")

PERITONEUM, HYSTERECTOMY CLAMPS

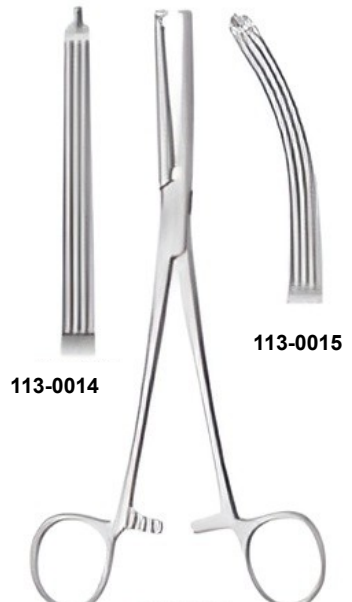

113-0014

113-0015

GWILLIAM HYSTERECTOMY 200mm(8")
113-0014 Straight
113-0015 Curved



113-0016

HEANY HYSTERECTOMY FORCEPS
200mm(8") **113-0016** Curved, Single
tooth



113-0017

113-0018

HEANY
113-0017 205mm(8")
113-0018 245cm (9.3/4")

HYSTERECTOMY CLAMPS



**MAINGOT GYSTERECTOMY
FORCEPS 113-0019** 200mm(8")
Curved, 1/2 teeth **113-0020**
Straight, 1/2 teeth **113-0021**
240mm(9.1/2") Curved, 1/2 teeth

PHANEUF 113-0022
205mm(8") Straight, 1/2
teeth

BONNEY 113-00203 205mm(8")
Angled on flat, 1/2 teeth



113-0024



113-0025



113-0026
220mm
(8.3/4")



113-0027
240mm
(9.1/2")



113-0028
225mm
(9")



113-0029



113-0030



113-0031

**HYSTERECTOMY
FORCEPS**
Atraumatic

PROCTOLOGY



KELLY PROCTOSCOPE
113-0032 140mm(5.1/2")
Diameter, 22mm

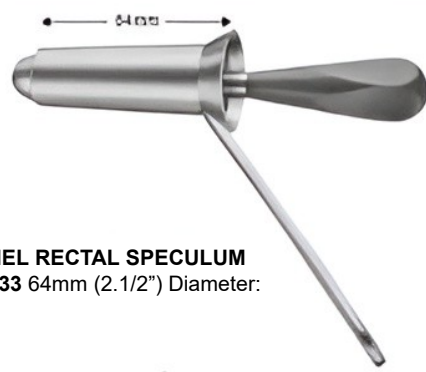

GABRIEL RECTAL SPECULUM
113-0033 64mm (2.1/2") Diameter:
25mm



MCEVEDY RECTAL SPECULUM WITH BATTERY HANDLE
113-0034 150mm(6")
Diameter: 27mm

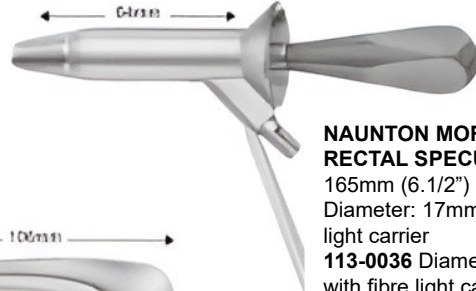

NAUNTON MORGAN RECTAL SPECULUM
165mm (6.1/2") 113-0035
Diameter: 17mm with fibre
light carrier
113-0036 Diameter:21mm
with fibre light carrier
113-0037 Diameter: 24mm
with fibre light carrier



PRATT RECTAL SPECULUM 113-0038 205mm (8")



CZERNY RECTAL SPECULUM 113-0039 225mm(9")



SIMS RECTAL SPECULUM 113-0040 160mm (6.1/4")

UROLOGY



113-0041
A
230mm(9")

113-0042
B
200mm(8")

113-0043
C
195mm(7.3/4)

113-0044
D
180mm (7")



RANDALL
Renal calculus
forceps



MILLIN
113-0045
245mm(9.3/4")
Ligature holding
forceps



BLADDERSPATULA
113-0046 235mm(9.3/4")
Blade:91mm/61mm



GUYON 113-0047
265mm (10.1/2")

KIDNEY CLAMP
113-0048 255mm(10")

UROLOGY



HERRICK 113-0049
225mm (9")

113-0050	6/10	(2.3/33mm)
113-0051	8/12	(2.66/4.66")
113-0052	10/14	(3.33/4.66)
113-0053	12/16	(4/5.33mm)
113-0054	14/18	(4.66/6mm)
113-0055	16/20	(5.33/6.66)
113-0056	18/22	(6/7.33)
113-0057	20/24	(6.66/8)
113-0058	22/26	(7.33/8.66)
113-0059	24/28	(8/9.33)
113-0060	26/30	(8.66/33)
113-0061	28/32	(9.33/10.66)

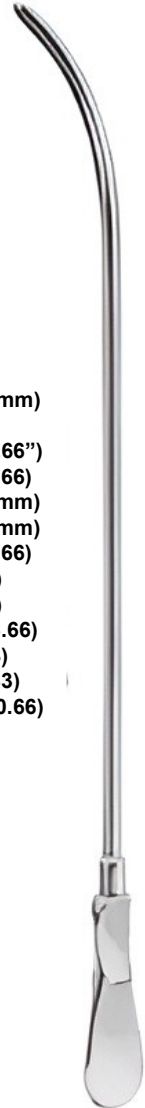

COTTON URETHRAL SOUNDS
265mm (10.1/2") Set Twelve
112-0062 Set comprising one
of each of:



FEMALE CATHETERS
160mm (6.1/4")

113-0062	12 (4mm)
113-0063	8 (3.33mm)
113-0064	10 (3.33mm)
113-0065	14 (4.66mm)
113-0066	16 (5.33mm)

SUCTION TUBES



113-0069
240mm (9.1/2")

POLE

113-0070
180mm (7")
Lawrie extension piece



YANKAUER 113-0067
305mm (12")

113-0068
Rose end

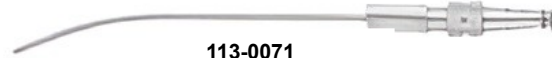

113-0071
GILLIES 170mm
(6.3/4") Control
value

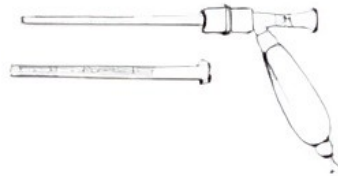

TINCKLER (SIMPSON SMITH) 113-0072 255mm
(10") With on/off value , removable perforated outer
sheath

UROLOGY



BARRON 113-0073
230mm (9")
Diameter: 1.33mm



FRAZIER 113-0074 185mm
(7.1/4") Diameter 2.33mm
113-0075 185mm (7.1/4")
Diameter 2.66mm
113-0076 185mm (7.1/4")
Diameter 3mm

BELUCCI 113-0077 Set comprising of each of the following items: **BELUCCI SUCTION TUBE 113-0078** 170mm (6.3/4") Diameter: 2mm **ZOELLNER DETACHABLE ENDS**

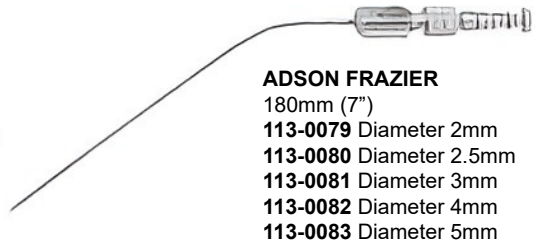

ADSON FRAZIER
180mm (7")
113-0079 Diameter 2mm
113-0080 Diameter 2.5mm
113-0081 Diameter 3mm
113-0082 Diameter 4mm
113-0083 Diameter 5mm

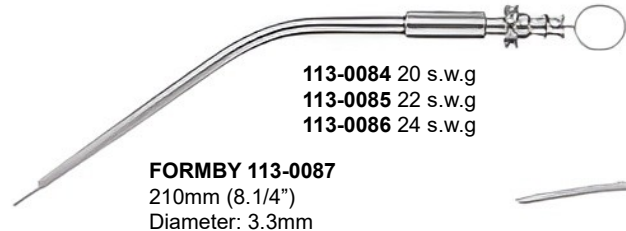

113-0084 20 s.w.g
113-0085 22 s.w.g
113-0086 24 s.w.g

FORMBY 113-0087
210mm (8.1/4")
Diameter: 3.3mm



ADSON 180mm (7")
113-00088 Diameter 3mm
113-0089 Diameter 5mm

HOUSE Shaft: 90mm (3.1/2")
Suction and irrigation tube

113-0090 Diameter Suction tube:
0.9mm Diameter irrigation tube:
0.7mm

113-0091 Diameter suction tube:
1.2mm Diameter irrigation tube:
0.9mm

113-0092 Diameter suction tube:
1.5mm Diameter irrigation tube:
1.2mm



CONE SUCTION TUBES
113-0093



SUCTION TUBES 113-0094
Diameter: 3mm
113-0095 Diameter: 4mm
113-0096 Diameter: 5mm

HANDLE 113-0097 100mm
(4") with tucker valve

AMPUTATION INSTRUMENTS



**PERCY AMPUTATION FLAP
RETRACTOR**

114-0001
Removable handles



AMPUTATION SAW
With hinged back
to take apart
114-0002
Blade: 230mm (9")

114-0003
Spare blade for
amputation saw



FINGER SAW
114-0004
200mm (8")



**ARMY REGULATION
AMPUTATION SAW**

114-0005
Blade: 182mm (7")
With hinged back
to take apart

UROLOGY BONE LEVERS & RASPATORIES

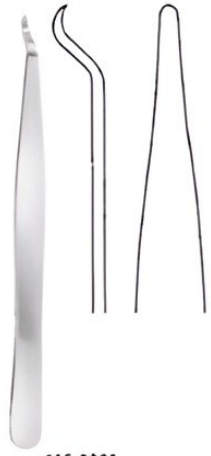

115-0001
140mm (5.1/2")
Width at tip 2.8mm



115-0002
160mm (6")
Width at tip 6mm

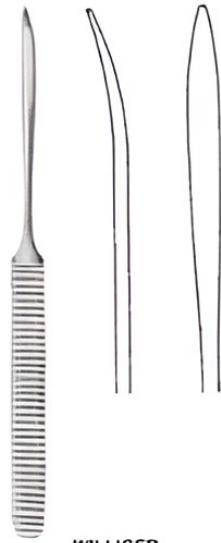

WILLIGER
115-0003
175mm (7")
Width at tip 5.5mm



WILLIGER
115-0004
160mm (6.1/4")
Width at tip 6.5mm

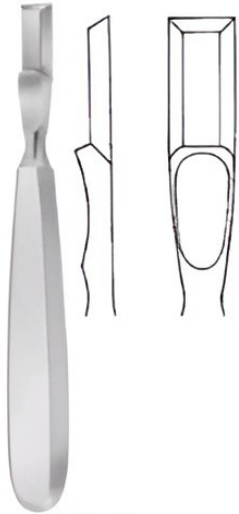

FARABEUF
100mm (4.1/4")
8mm wide
115-0005 Straight
115-0000 Curved



HOWARTH
115-0007 220mm (9")



JOSEPH
115-0007
170mm (6.3/4")
Width at tip 4mm



MACDONALD
115-0008
185mm (7.1/4") blunt



FRIGER ELEVATOR
115-0009
100mm (7.1/2"),
double ended

BONE LEVERS & RASPATORIES



ADSON
105mm (0.1/2"), curved
115-0010 width 5mm
115-0011 width 7mm

ADSON
105mm (0.1/2") slight curve
115-0012 Width 7mm

PENNYBACKER
100mm (0")
115-0013
Width 5mm

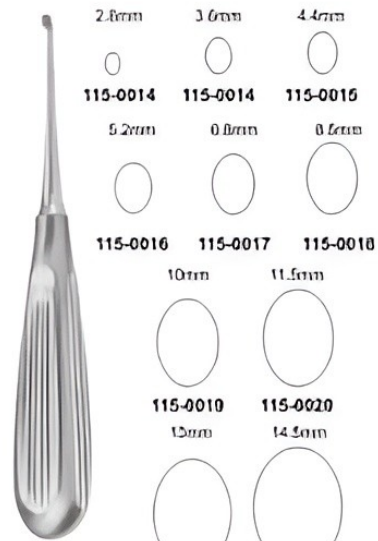

VOLKMANN
170mm (0.3/4")

2.8mm	3.0mm	4.4mm
115-0014	115-0014	115-0016
5.2mm	6.0mm	8.0mm
115-0016	115-0017	115-0018
10mm	11.5mm	
115-0019	115-0020	
13mm	14.5mm	
115-0021	115-0022	

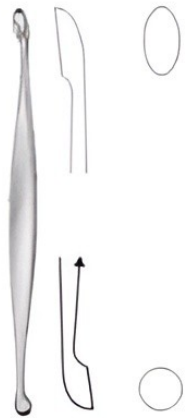

BOYD BONE CURETTE
Oval, double ended
115-0023 130mm (0.1/1")



BOYD BONE CURETTE
Oval, double ended
115-0024 100mm (0.1/4")



BOYD BONE CURETTE
Oval, double ended
115-0025 200mm (0.8")

BONE SCOOPS



VOLKMANH
Double ended
115-0026
130mm (5 1/8")
115-0027
140mm (5 1/2")
115-0028
170mm (6 3/4")



MACEWEN
180mm (7")
Combined
with scalpel
115-0029
Oval
115-0030
Round



JACOBSON
115-0031
140mm (5 1/2")



MARTINI
115-0032
140mm (5 1/2")



MARTINI
115-0033
140mm (5 1/2")



LEMPERT
200mm (8")*

115-0014
2mm x 3.5mm

115-0015
2mm x 4mm

115-0016
2.5mm x 4.5mm

115-0017
2.75mm x 5mm

115-0018
3mm x 5mm

115-0019
3.25mm x 5mm



COLLIER AND MORRIS
180mm (7")

115-0040
2mm x 3mm

115-0041
3mm x 4mm

115-0042
4mm x 5mm

115-0043
5mm x 6mm



LUCAS
116-0001
Diameter: 27mm
8.1/2 oz



KELSEY FRY
116-0002 190mm (7.1/2")
Diameter: 20mm
SPARE DISKS
116-0003 Spare disks for
Kelsey-Fry Mallet



HEATH
116-0004
Diameter: 25mm 20 oz
116-0005
Diameter: 40mm 36 oz

MALLETS, BONE HOLDING FORCEPS



SEQUESTUM
FORCEPS
116-0006
190mm (7.1/2")
Straight



SEQUESTUM
FORCEPS
116-0007
190mm (7.1/2")
Angled



FERGUSON
116-0008
250mm (8")

BONE HOLDING FORCEPS

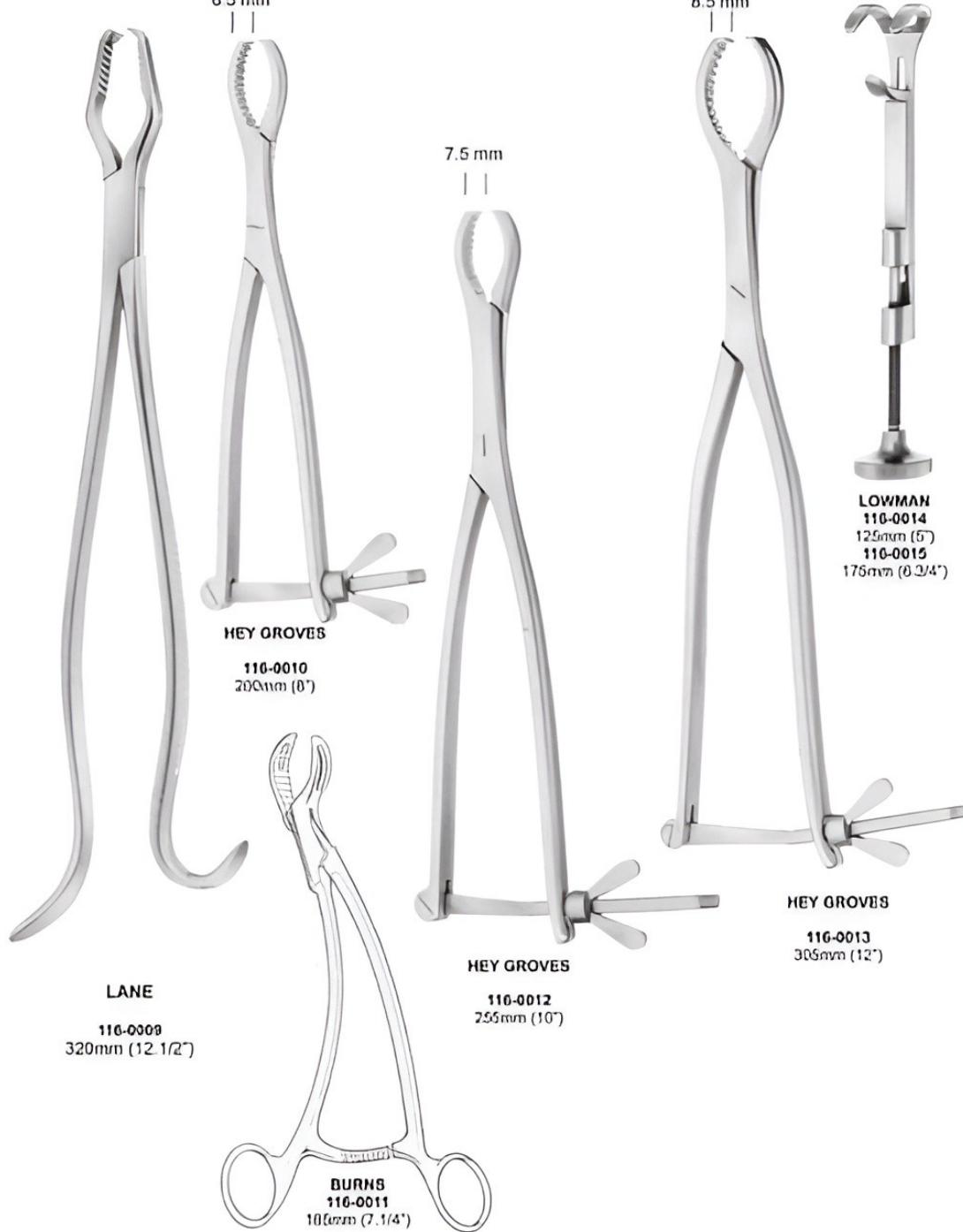



BEYER
117-0001
150mm (6")
5mm bite



**JANßEN-MIDDLETON
SEPTUM FORCEPS**
117-0002
200mm (8") Spoon shaped
4mm bite



CAIRNS
117-0003
140mm (5 1/2")
4mm bite



CAIRNS
117-0004
140mm (5 1/2")
4mm bite



LUER
117-0005
105mm (6")

BONE RONGEURS



RUSKIN
117-0006
180mm (7 1/2")
6mm bite

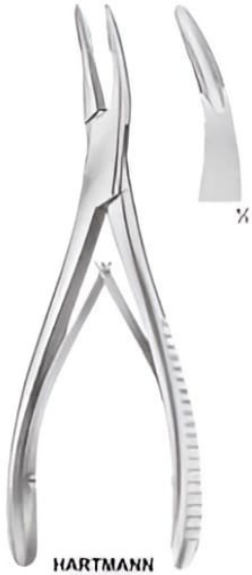

HARTMANN
117-0007
180mm (7")



MEAD
117-0008
165mm (6 1/2")



JANßEN
117-0009
150mm (6")

BONE RONGEURS



LUER-JANSEN
117-0010
170mm (6 3/4")
4mm bite



BEYER
117-0020
180mm (7")



BEYER
117-0021
200mm (8")



KILLEARN
117-0022
107mm (7 3/4")
3mm bite



ZAUFAL-JANSEN
117-0023
240mm (9 1/2")



ECHLIN
117-0024
240mm (9 1/2")



NORTHFIELD
117-0025
225mm (9") 10mm bite

BONE RONGEURS



TROTTER
117-0010
200mm (8")
10mm bite



**SYNOVECTOMY
RONGEUR**
117-0011
175mm (7")
4mm bite



HEANLEY
117-0012
175mm (7")
4mm bite



PENNYBACKER
117-0013
200mm (8")
4mm bite



**SYNOVECTOMY
RONGEUR**
117-0014
130mm (5 1/8")
Jaw width 2mm



NORTHFIELD
117-0015
200mm (8")
10mm bite



WILMS
117-0010
200mm (8")
4mm bite

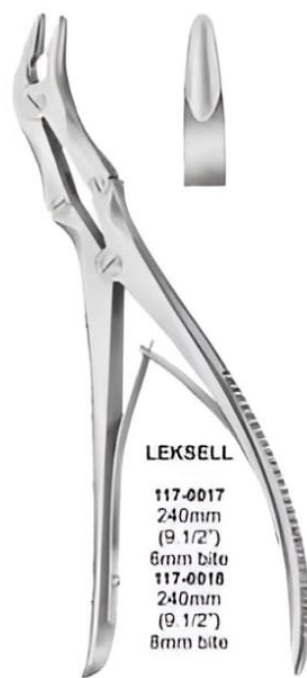

LEKSELL
117-0017
240mm
(9 1/2")
6mm bite
117-0018
240mm
(9 1/2")
8mm bite

BONE RONGEURS



SARGENT (VAN HAVRE)
117-0026
220mm (8.3/4")
10mm bite



OLIVECRONA
117-0027
230mm (9")
6mm bite



STILLE-RUSKIN
117-0028
240mm (9.1/2")

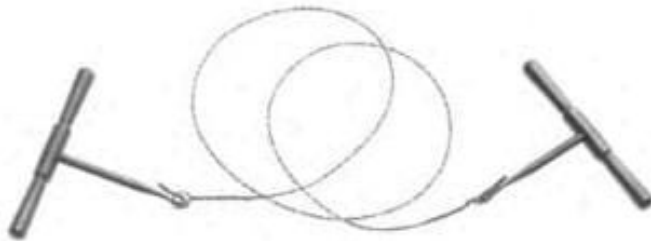

GIGLI SAW WITH HANDLE

117-0029
500mm (20")



RUDOR EDWARDS COSTOTOME

117-0030
230mm (9")

DISC RONGEURS

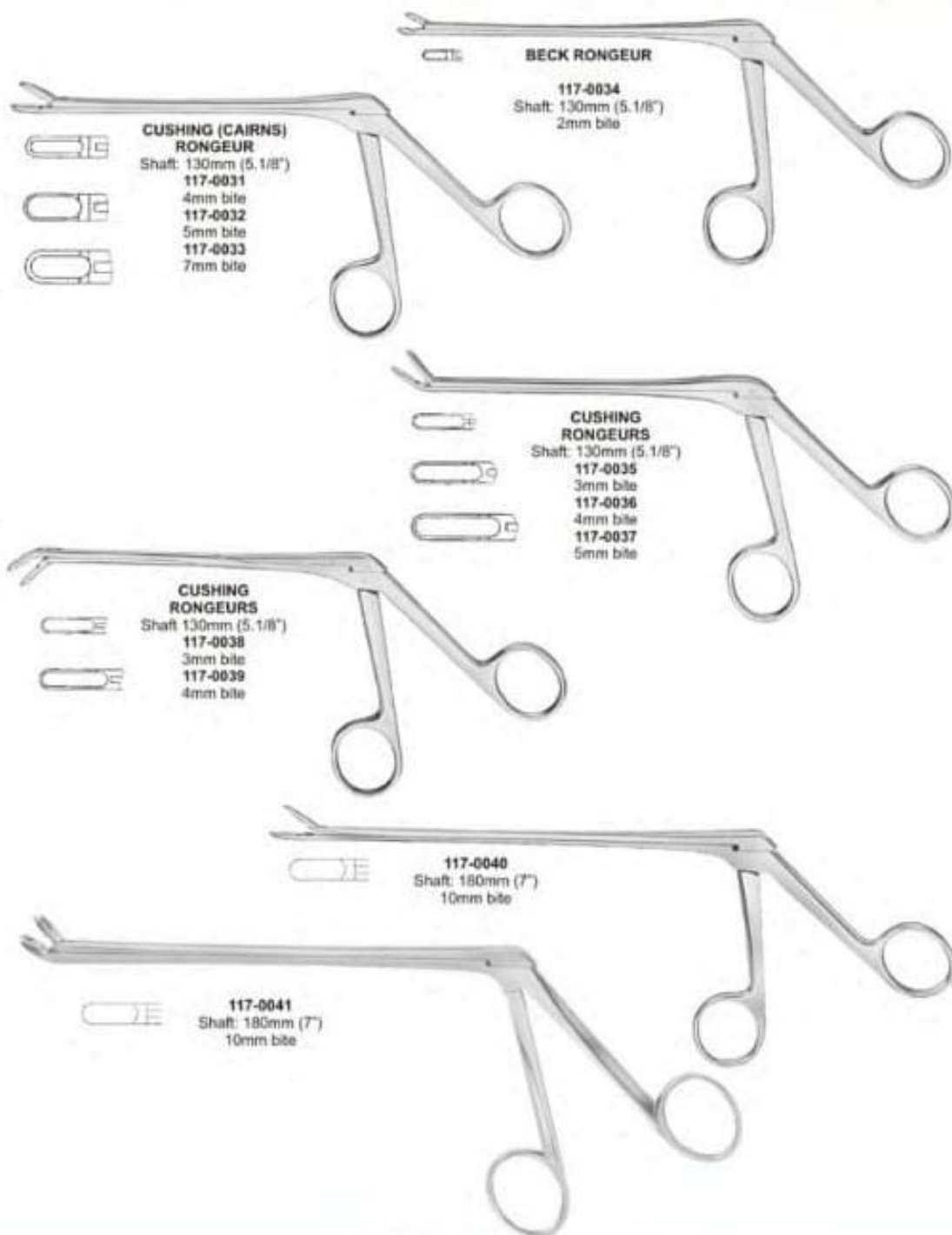

BONE CUTTING FORCEPS



RUBKIN - LISTON
117-0042 100mm (7.1/2")
Straight
117-0043 100mm (7.1/2")
Angled on flat



WARD
117-0044
170mm (6.3/4")



117-0045
145mm (5.3/4")



117-0046
150mm (6")



DE VILDBERG
117-0047
210mm (8.1/4")



**LISTON
(TUDOR EDWARDS)**
117-0048
205mm (10.1/2")

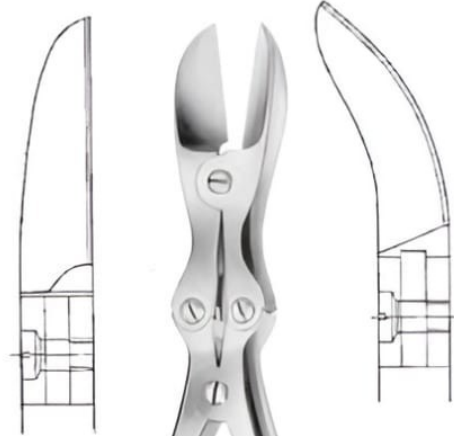

**STILLE
LISTON**
117-0049
210mm (11")
Straight
117-0050
270mm (10.3/4")
Curved on flat

PLASTER CAST REMOVAL INSTRUMENTS



PLASTER SHEARS

110-0001
100mm (0.1M')



PLASTER SHEARS

110-0002
200mm (0')

110-0003
230mm (0')



PLASTER SHEARS

110-0004
230mm (0.1/4')

RIB SPREADERS

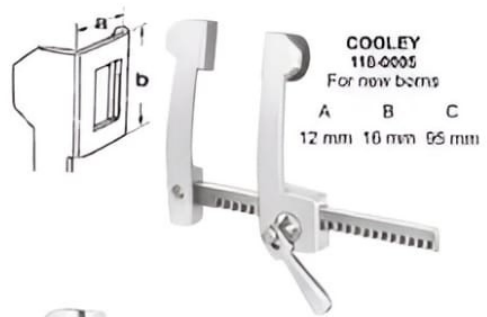

COOLEY
110-0005
For new borns
A B C
12 mm 10 mm 95 mm

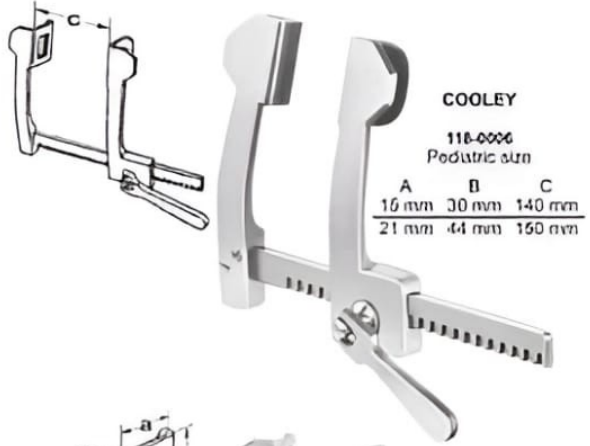

COOLEY
110-0006
Pediatric size
A B C
10 mm 30 mm 140 mm
21 mm 44 mm 160 mm



COOLEY
110-0007
For adults
A B C
35 mm 50 mm 200 mm



FINOCCHIETTO - INFANT
110-0003
For babies

a	b	c
15mm	15mm	70mm

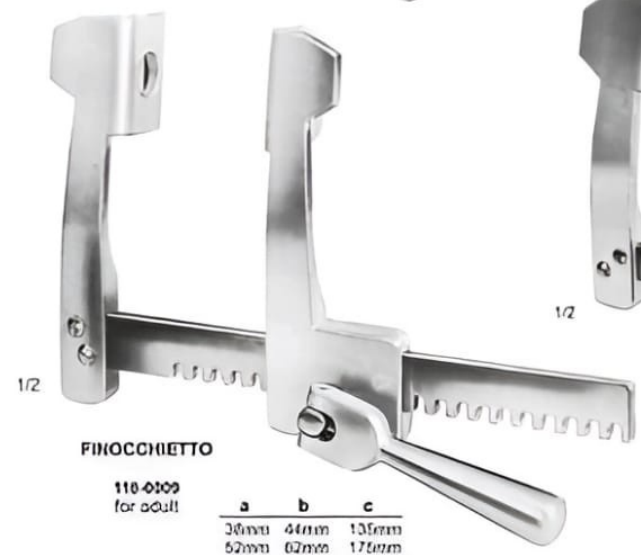

FINOCCHIETTO

110-0009
for adult

a	b	c
30mm	44mm	135mm
52mm	62mm	170mm
85mm	85mm	175mm

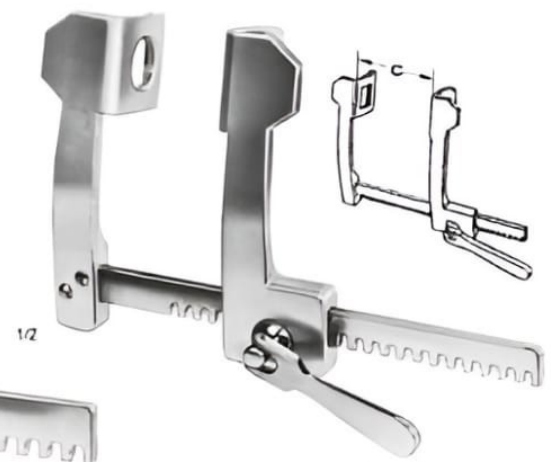

FINOCCHIETTO-BABY
110-0010
Child size

a	b	c
31mm	31mm	102mm

RIB SPREADERS

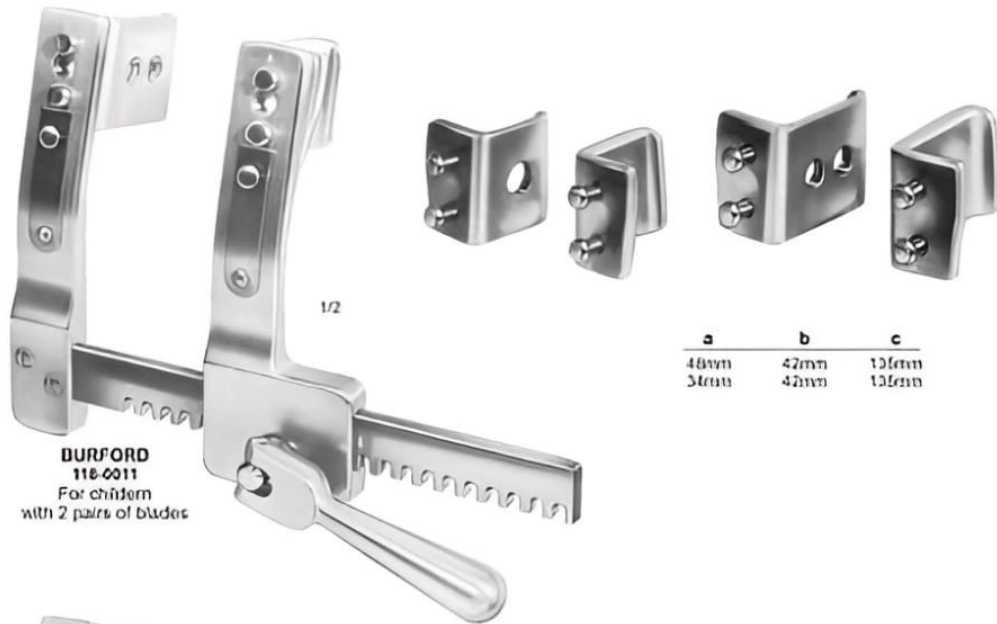

BURFORD
118-0011
For children
with 2 pairs of blades

a	b	c
48mm 36mm	42mm 42mm	13mm 13mm



BURFORD
118-0012
for adults
with pairs of blades

a	b	c
64mm 47mm	62mm 62mm	16mm
65mm 47mm	62mm 62mm	26mm
65mm 47mm	62mm 62mm	30mm

BRONCHUS, LIGATURE, TISSUE & ORGAN HOLDING FORCEPS



PRICE-THOMAS
119-0001 220mm (8 3/4")

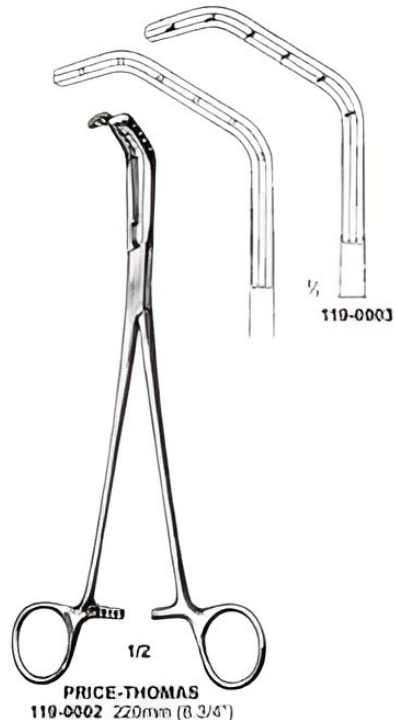

PRICE-THOMAS
119-0002 220mm (8 3/4")

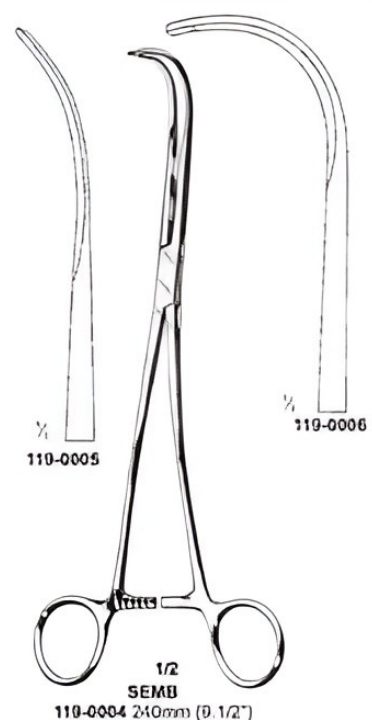

SEMB
119-0004 240mm (9 1/2")



LOVELACE
Straight
119-0007
200mm (8")

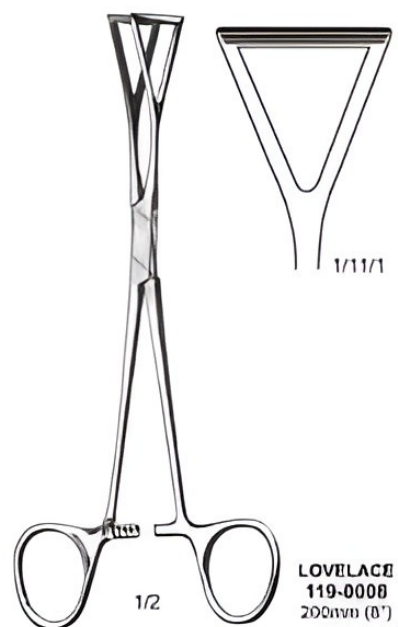

LOVELACE
119-0008
200mm (8")

ATRAUMA BULLDOG CLAMPS



1/1
DE-BAKEY SATINSKY
119-0009 70mm (2.3/4")



1/1
DE-BAKEY-CAROTIS
110-0010 92mm (3.1/2")



1/1
DE-BAKEY SATINSKY
110-0011 100mm (4")

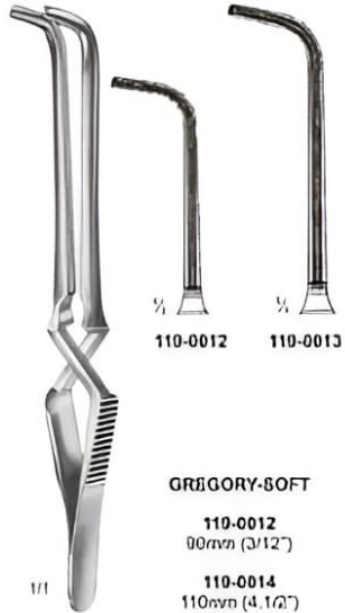

1/1
GREGORY-SOFT
110-0012
90mm (3.1/2")
110-0014
110mm (4.1/4")



1/1
DEBAKEY BULLDOG CLAMPS



1/1
119-0014
75mm (3")



1/1
119-0015
85mm (3.1/2")



1/1
119-0016
105mm (4.1/4")



1/1
119-0017
120mm (4.3/4")



1/1
DEBAKEY BULLDOG CLAMPS



1/1
119-0018
70mm (2.3/4")
1/1
119-0019
80mm (3.1/4")



1/1
119-0020
100mm (4")



1/1
119-0021
115mm (4.3/4")

ATRAUMA HEMOSTATIC, CARDIOVASCULAR FORCEPS



DE BAKAY-RANKIN
120-0001
Straight 160mm (6.1/4")
120-0002
Curved 160mm (6.1/4")

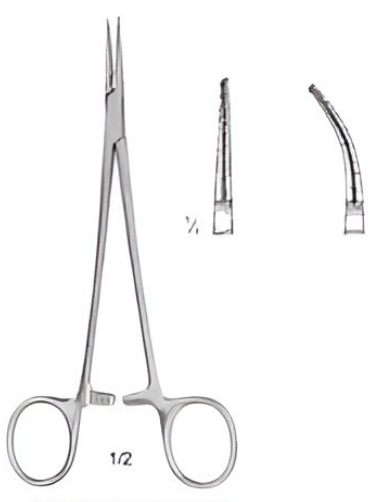

DE BAKAY-MOSQUITO
120-0003
Straight 160mm (6")
Curved 160mm (6")



OCHSNER
120-0004
235mm (9.1/4")



DIETRICH
120-0005
210mm (8.1/4")

ATRAUMA CARDIOVASCULAR FORCEPS

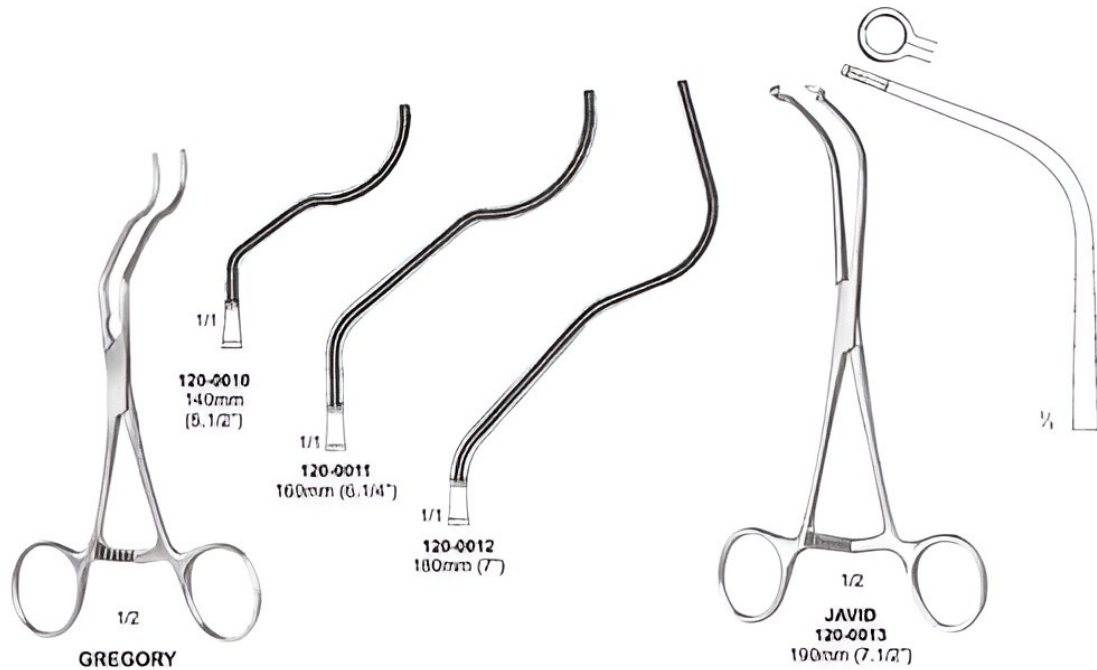
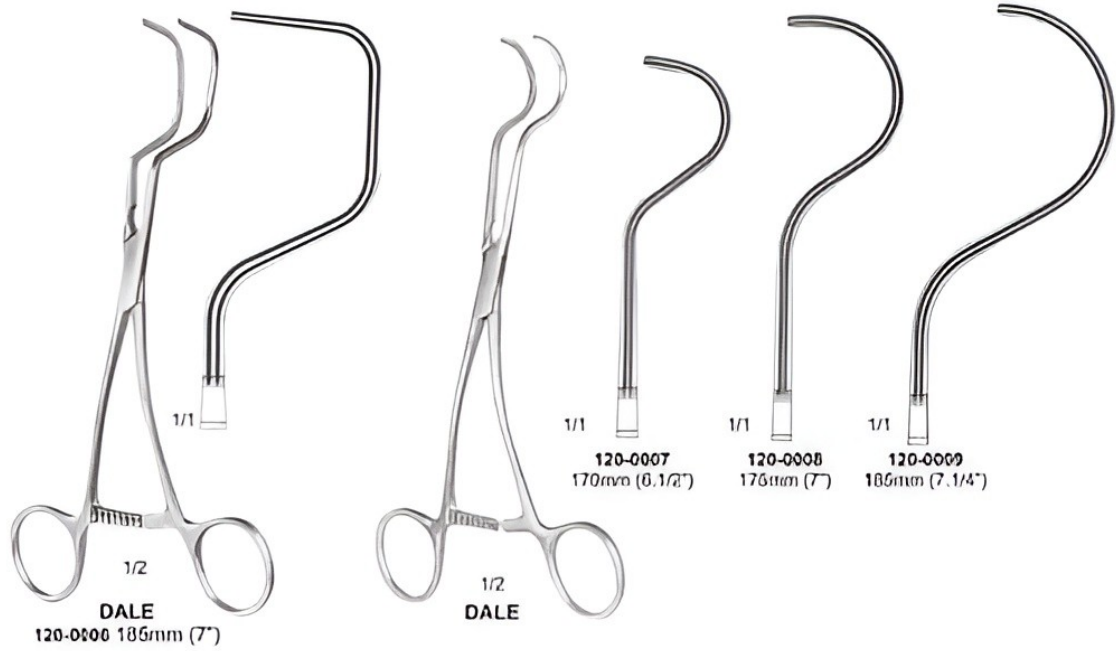

AUTRAUMA CARDIOVASCULAR FORCEPS

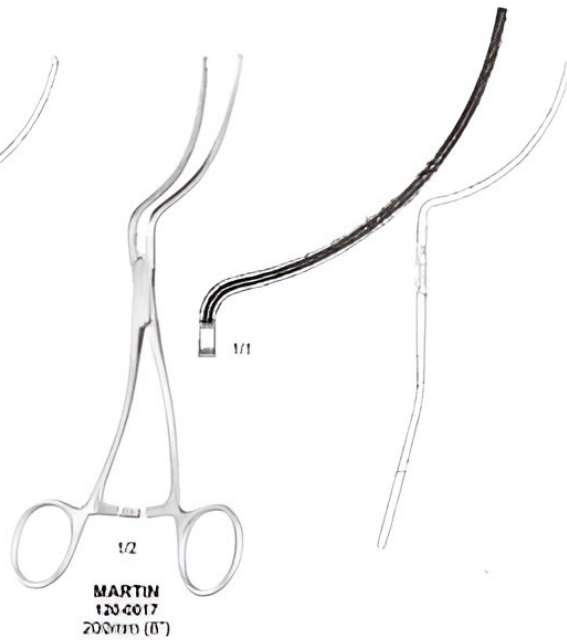
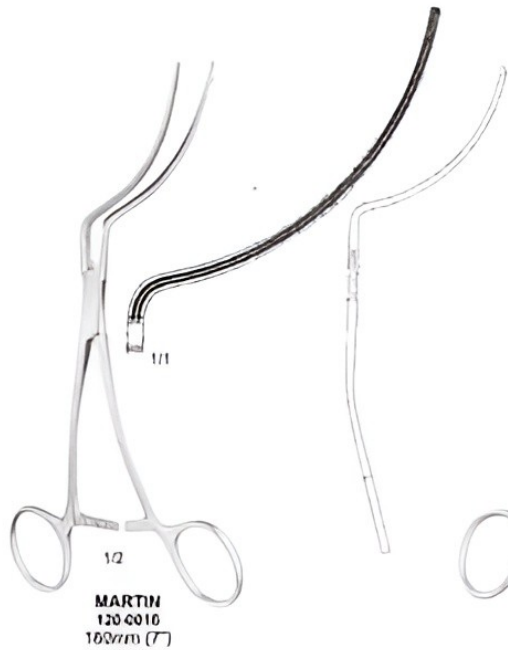
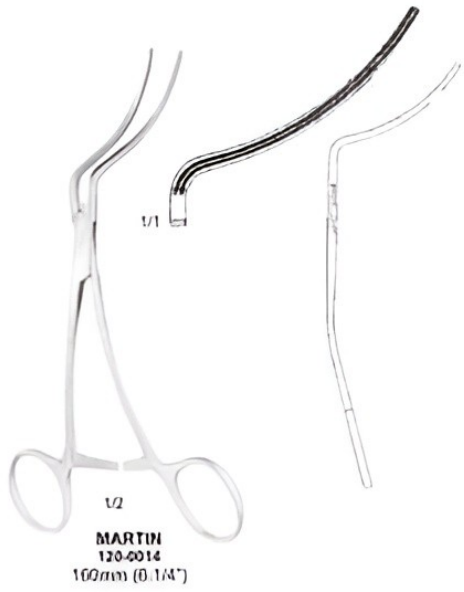

VASCULAR MEASURING DEVICE, FORCEPS

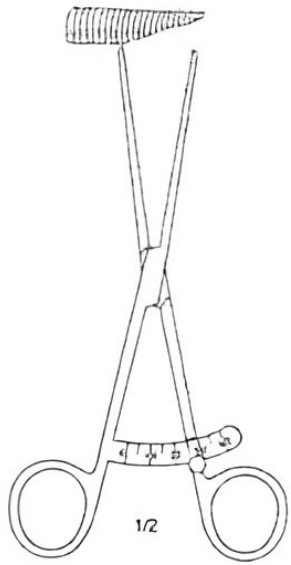

MEASURING FORCEPS

120-0018
Straight - 180mm (7")

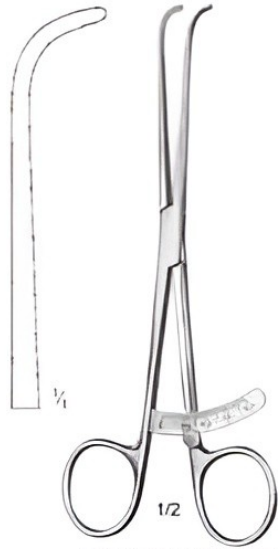

MEASURING FORCEPS

120-0010
Straight - 180mm (7")

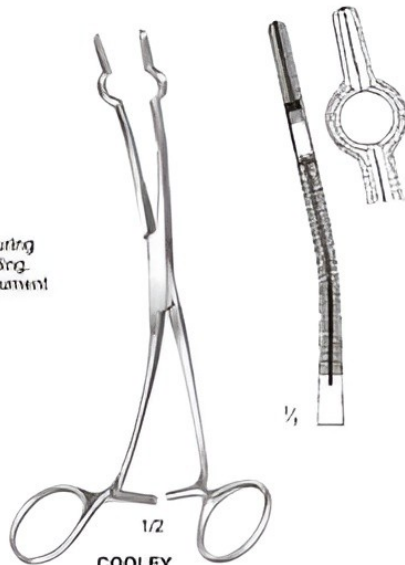
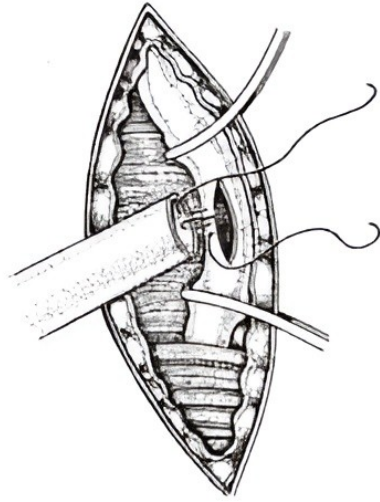

1/2
COOLEY
120-0020
old
120-0021
new

Cooley type caval occlusion used during cardiopulmonary By-Pass for occluding the vena cava. The tips of the instrument point down indicating caecula

AUTRAUMA TISSUE FORCEPS



DE BAKLEY

- 120-0022 100mm (0.1/4")
- 120-0023 200mm (0")
- 120-0024 240mm (0.1/4")
- 120-0025 300mm (12")



DE BAKLEY

- 120-0026 160mm (0.1/4")
- 120-0027 200mm (0")
- 120-0028 240mm (0.1/4")

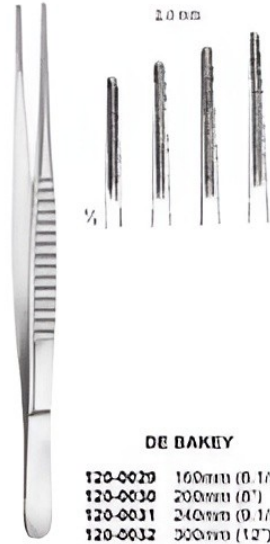

DE BAKLEY

- 120-0029 160mm (0.1/4")
- 120-0030 200mm (0")
- 120-0031 240mm (0.1/4")
- 120-0032 300mm (12")

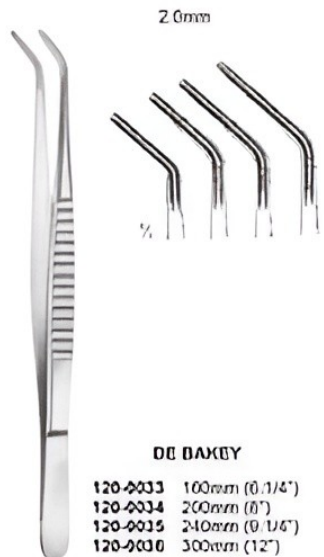

DE BAKLEY

- 120-0033 100mm (0.1/4")
- 120-0034 200mm (0")
- 120-0035 240mm (0.1/4")
- 120-0036 300mm (12")

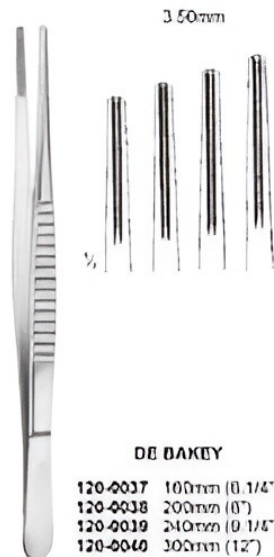

DE BAKLEY

- 120-0037 160mm (0.1/4")
- 120-0038 200mm (0")
- 120-0039 240mm (0.1/4")
- 120-0040 300mm (12")



COOLEY

- 120-0041 160mm (0.1/4")
- 120-0042 200mm (0")

AUTRAUMA CARDIOVASCULAR FORCEPS

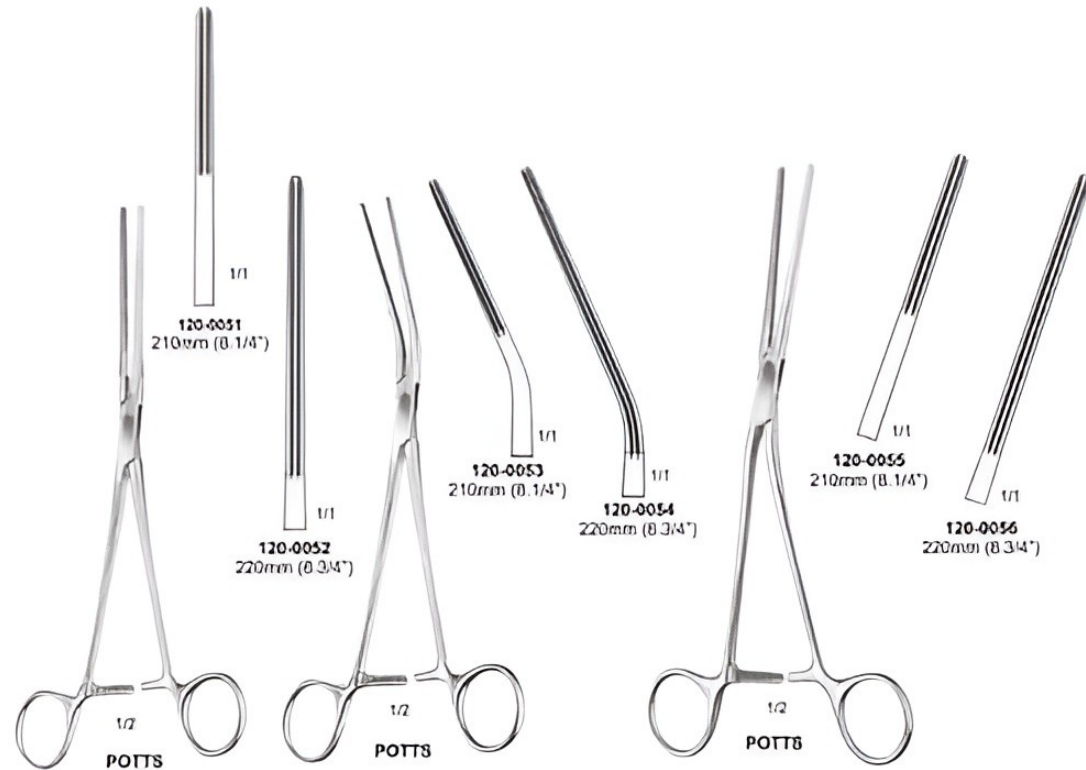
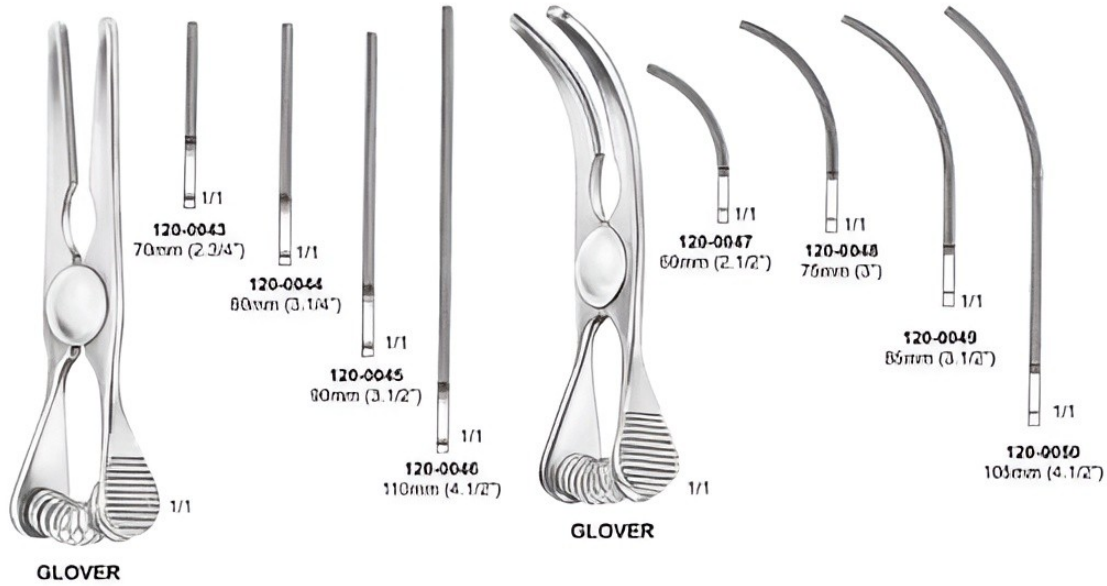

AUTRAUMA CARDIOVASCULAR FORCEPS

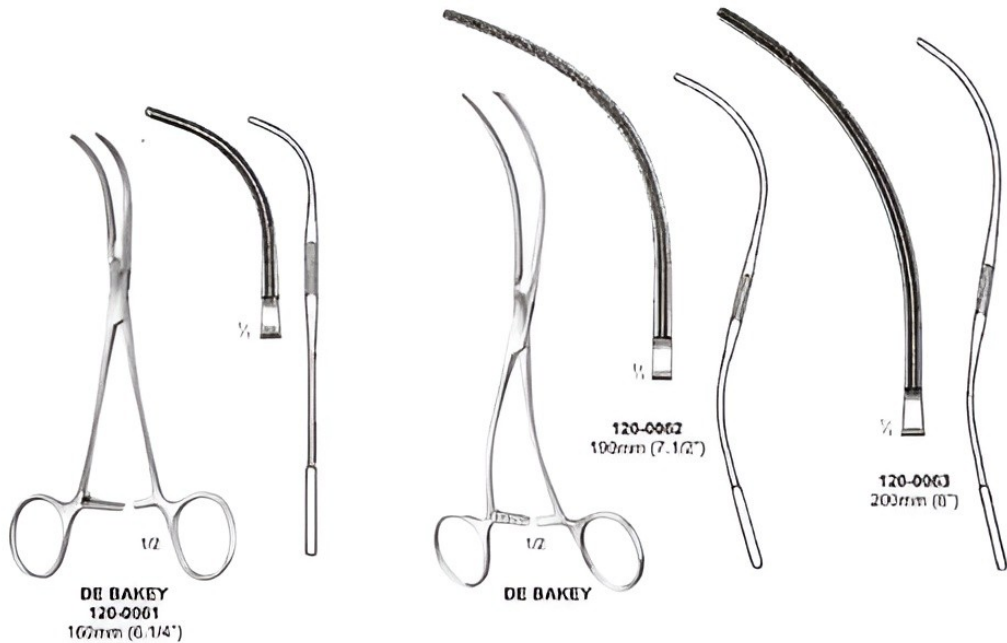
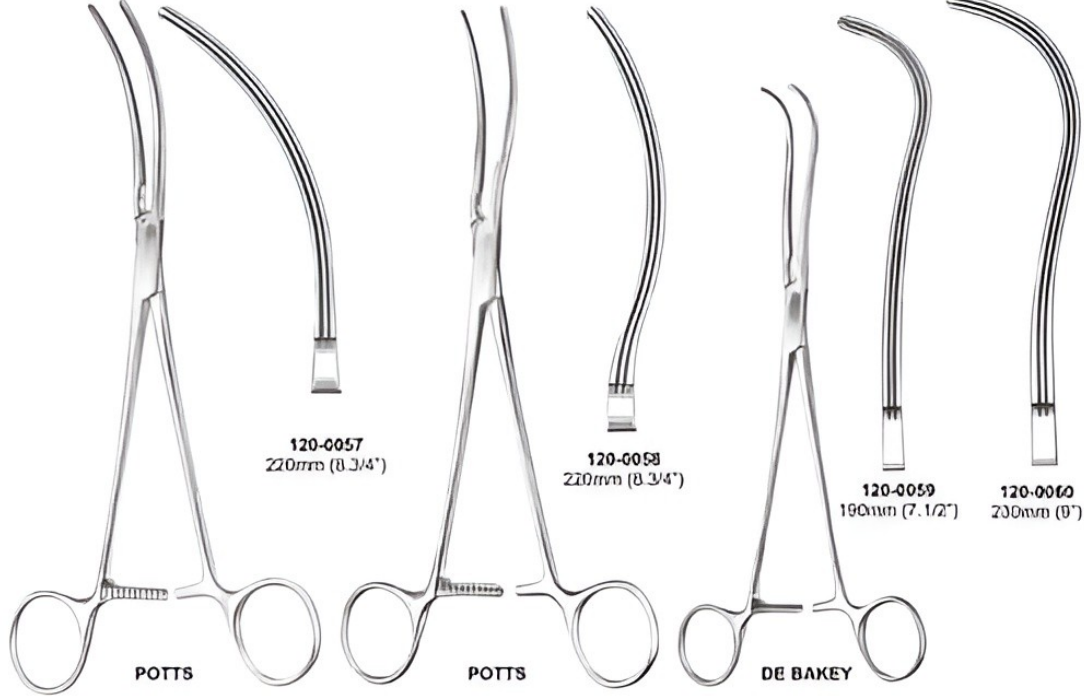

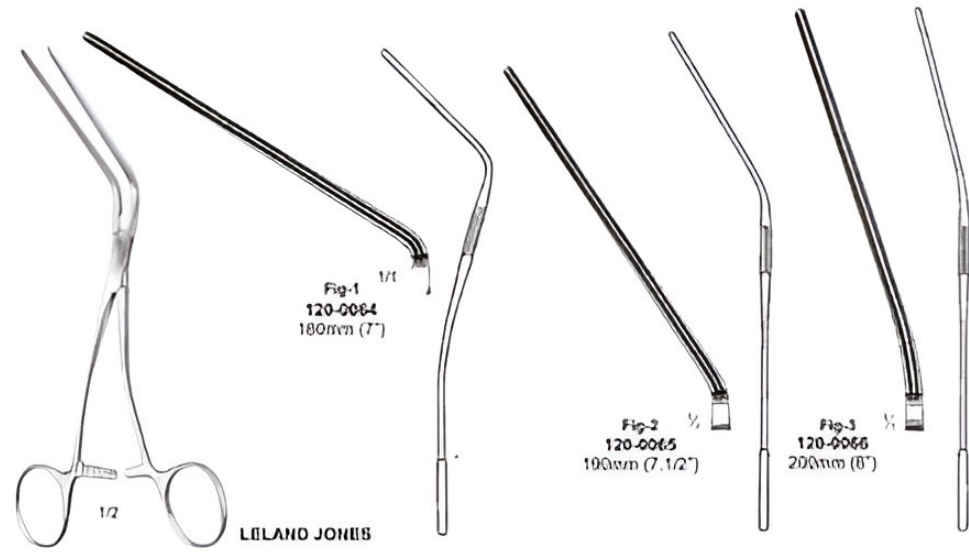

AUTRAUMA CARDIOVASCULAR FORCEPS

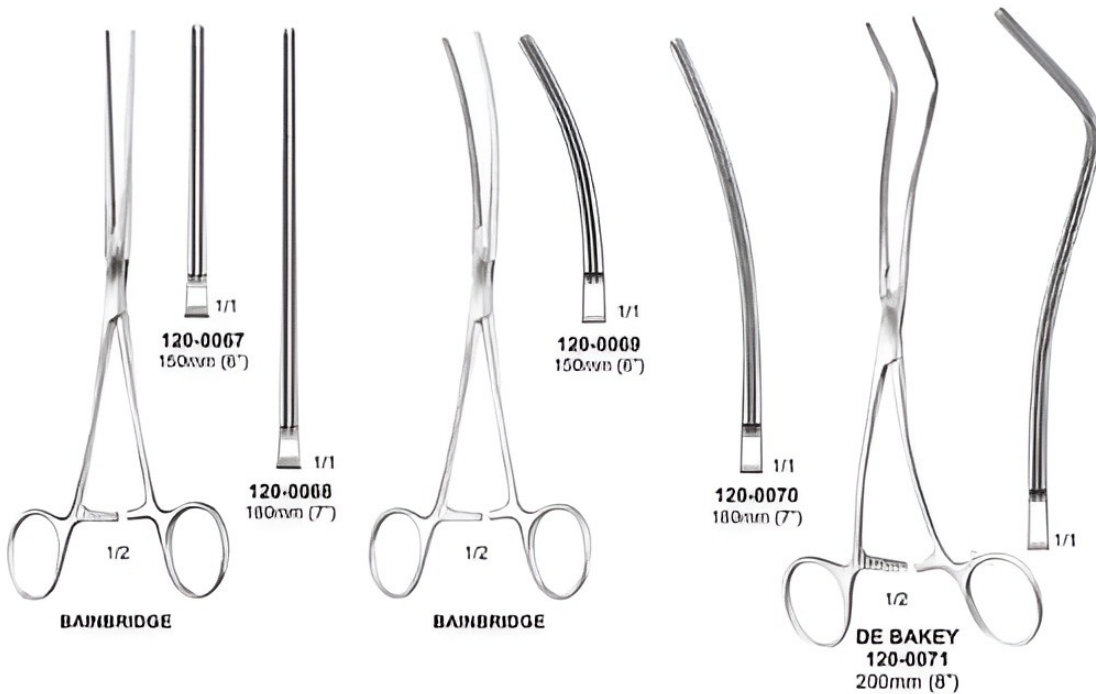

AUTRAUMA CARDIOVASCULAR FORCEPS



ANEURYSM CLAMP

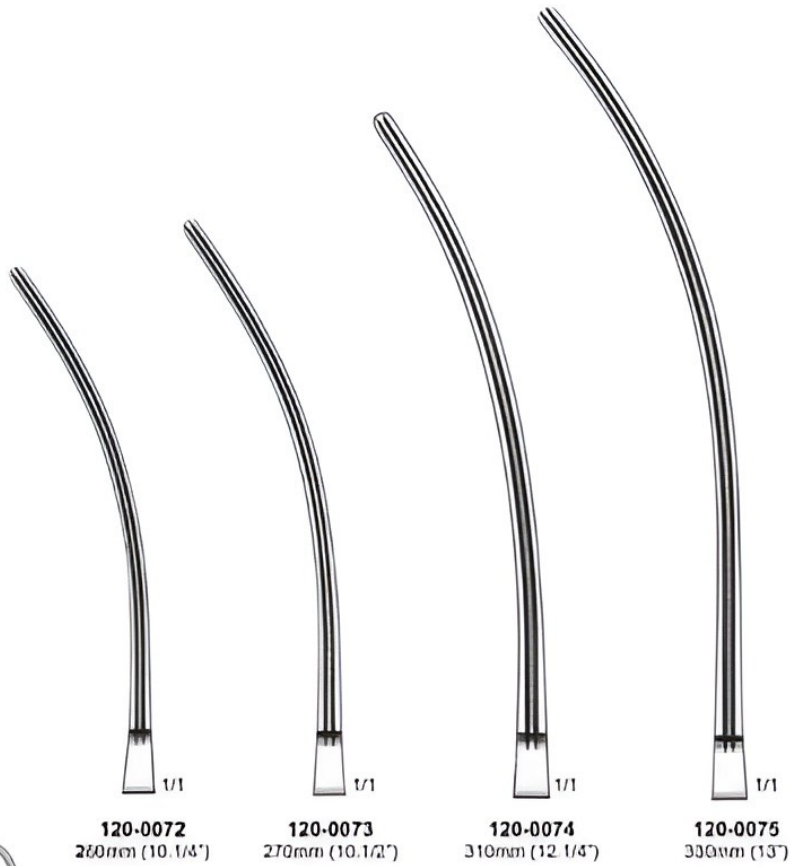

120-0072
260mm (10.1/4")

120-0073
270mm (10.1/2")

120-0074
310mm (12.1/4")

120-0075
330mm (13")

AUTRAUMA CARDIOVASCULAR FORCEPS



AUTRAUMA CARDIOVASCULAR FORCEPS



DE BAKAY
120-0070
280mm (10")



DE BAKAY
120-0080
250mm (10")

ATRAUMA CARDIOVASCULAR FORCEPS

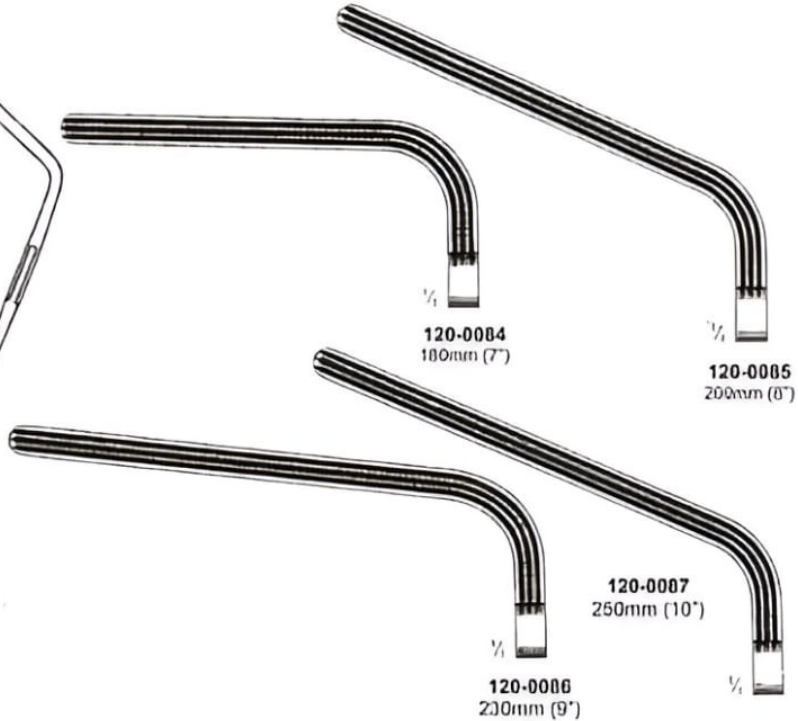
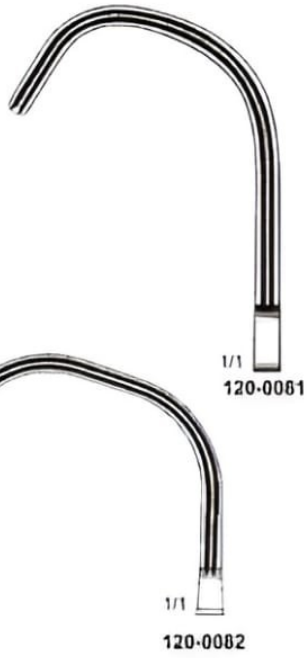

AUTRAUMA CARDIOVASCULAR FORCEPS

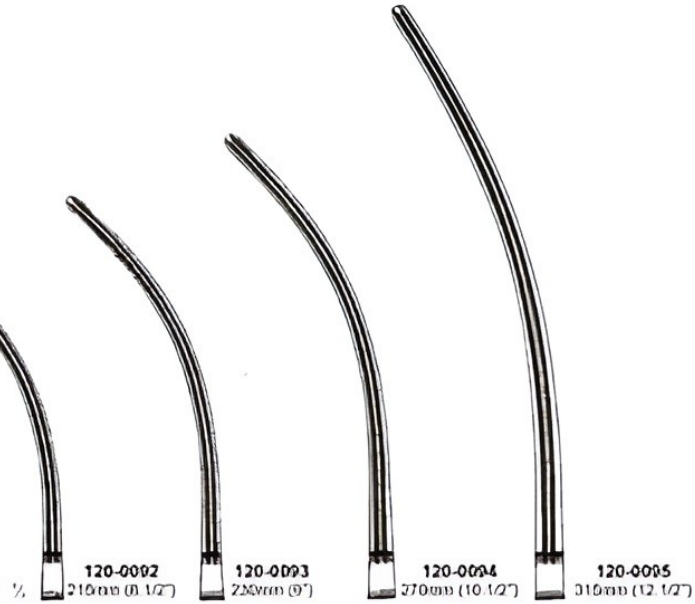
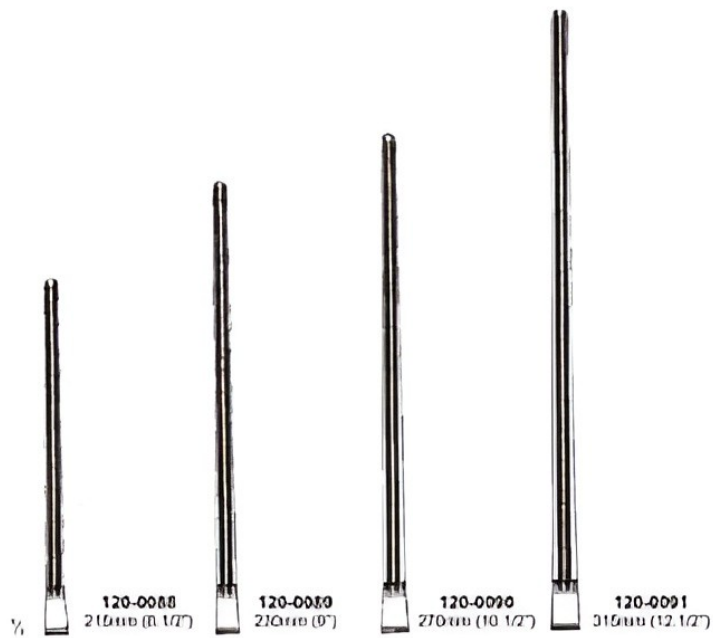

ATRAUMA CARDIOVASCULAR FORCEPS

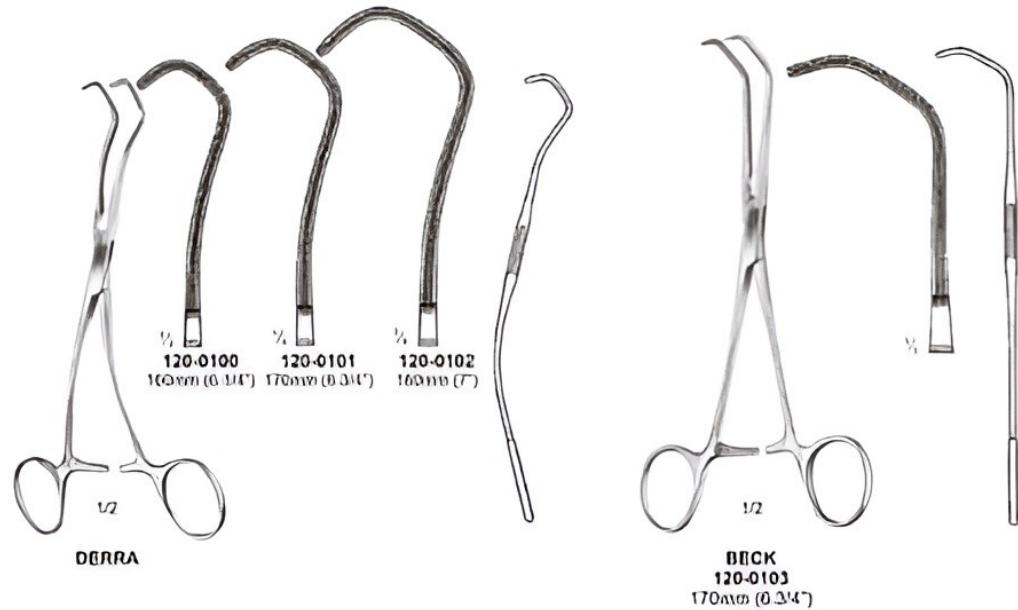
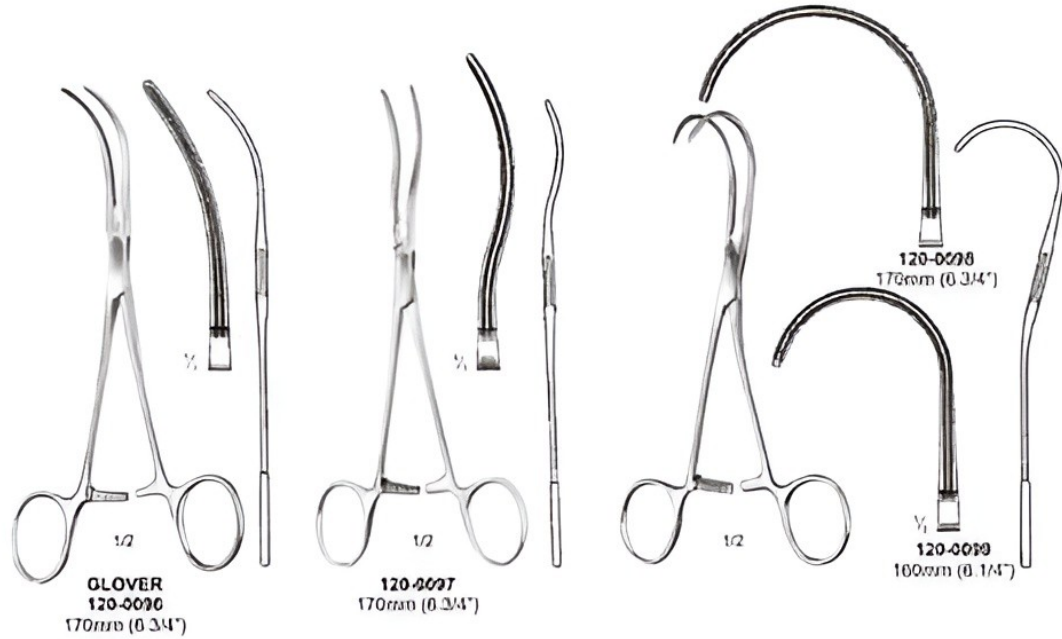

VASCULAR DILATORS

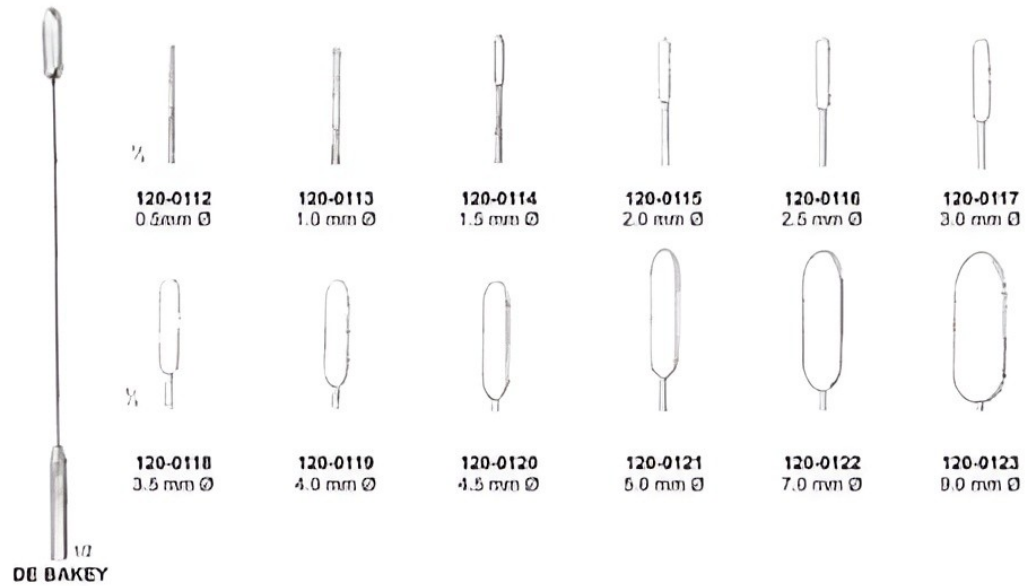
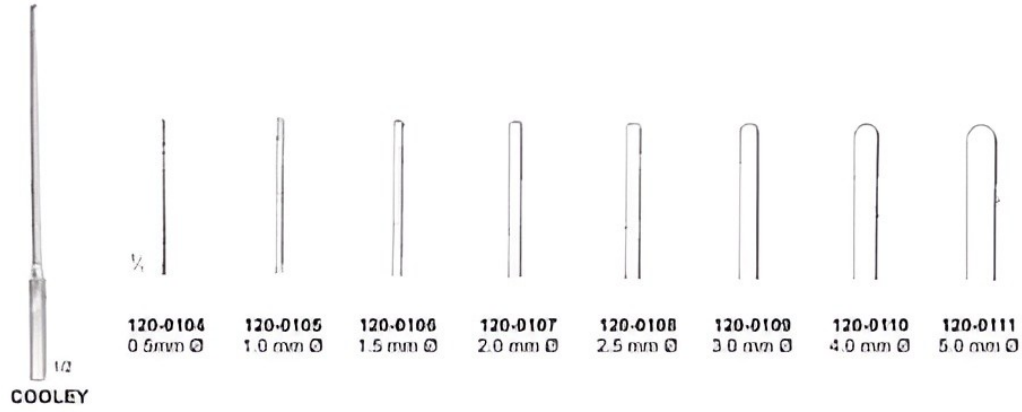

BIPOLAR FORCEPS



McPHERSON
121-0001
70mm
(2.74")
Straight



McPHERSON
121-0002
70mm
(2.74")
Angled



**JEWELER
FORCEPS**
121-0003
110 mm
(4.14")
Straight



**JEWELER
FORCEPS**
121-0004
110 mm
(4.14")
Angled



**JEWELER
FORCEPS**
121-0005
110 mm
(4.14")
Curved



BIPOLAR FORCEPS
Straight
121-0006 160mm (6")
121-0007 180mm (7")
121-0008 200mm (8")
121-0009 220mm (8.1/2")
121-0010 240mm (9.1/2")

BIOPOLAR FORCEPS



**BIPOLAR FORCEPS
BAYONETT**
 121-0011 140mm (5")
 121-0012 240mm (9")
 121-0013 220mm (8.1/2")
 121-0014 240mm (9.1/2")



BIPOLAR FORCEPS
 Anisled Downward
 121-0015 140mm (5")
 121-0016 160mm (7")
 121-0017 200mm (8")
 121-0018 200mm (8.1/2")
 121-0019 240mm (9.1/2")



**BIPOLAR FORCEPS
BAYONETT**
 Anisled Upward
 121-0020 140mm (5")
 121-0021 160mm (7")
 121-0022 210mm (8.1/2")
 121-0023 240mm (9.1/2")



**BIPOLAR FORCEPS
BAYONETT**
 Anisled Downward
 121-0024 140mm (5")
 121-0025 160mm (7")
 121-0026 210mm (8.1/2")
 121-0027 240mm (9.1/2")

MONOPOLAR CABLES, FORCEPS

MONOPOLAR CABLES



- 121-0028 3 meter cable, Hook connector, cable with active instrument connector
- 121-0029 5 meter cable, Hook connector, cable with active instrument connector

- 121-0030 3 meter cable, 4mm plug, cable with active instrument connector
- 121-0031 5 meter cable, 4mm plug, cable with active instrument connector

- 121-0032 3 meter cable, 8mm Jack plug (Bovie) cable with active instrument connector
- 121-0033 5 meter cable, 8mm Jack plug (Bovie) cable with active instrument connector



- DISSECTING FORCEPS**
121-0034
150mm (6")
100mm (7")
- DISSECTING FORCEPS**
121-0035
250mm (10")
250mm (10")
- MCINDOE FORCEPS**
121-0036
150mm (6")
- ADSON**
121-0037
100mm (7.125")



- WILSON HEY FORCEPS**
121-0039 110mm (7")
121-0040 230mm (9")
- 121-0041**
120mm (5")
- 121-0042**
150mm (6")
- 121-0043**
100mm (7")
- 121-0044**
200mm (8")
- 121-0045**
230mm (9")
- RICHES FORCEPS**

MONOPOLAR HANDLES, BLADES, NEEDLE, TURNER WARWICK SCISSORS



HANDLE
For cut and
plate electrode carriers
121-0040
17mm (0.14")



HANDLE
For needles and loops
121-0047
202mm (8")



HANDLE
For needles and loops
121-0048
167mm (6")



BLADES
121-0049
Large Diameter
blade electrode
(Insulated)



BLADES
121-0050
Large Diameter
blade electrode
(Insulated)



BLADES
121-0051
Small
Diameter
blade electrode



NEEDLE
121-0052
Short Sharp



NEEDLE
121-0053
Long Insulated



NEEDLE
121-0054
Long Sharp
Angled



NEEDLE
121-0055
Long Sharp
Straight



**TURNER WARWICK
SCISSOR**
121-0056 125mm (5")
121-0057 145mm (5.7")
121-0058 160mm (6")
121-0059 180mm (7")
121-0060 230mm (9")



SCALPPE HANDLE
121-0001
Red. Not

DISSECTION INSTRUMENTS



122-0001

- 1- BLOW PIPE
- 2- 3 PCS. SCALPEL
- 3- DISSECTING FORCEP 13 CM
- 4- GROOVED DIRECTOR WITH TONGUE TIE 13 CM
- 5- TRIPLE CHAIN HOOK
- 6- DRESSING SCISSORS PROBE POINTED 13 CM
- 7- PROBE DOUBLE 13 CM
- 8- ZIPPER CASE INSIDE RED VELVET.



122-0002

- 1- PROBE DOUBLE 13 CM
- 2- 2 PCS. SCALPEL S.S.
- 3- GROOVED DIRECTOR WITH TONGUE TIE 13 CM
- 4- MAYO HEGAR NEEDLE HOLDER 13CM
- 5- DISSECTING FORCEP 13 CM 1/2 TEETH
- 6- DRESSING FORCEP 13 CMS SERRATED.
- 7- DRESSING SCISSOR 13 CM S/B STR.
- 8- DRESSING SCISSOR 13 CM S/B CVD.
- 9- ZIPPER CASE INSIDE RED VELVET.

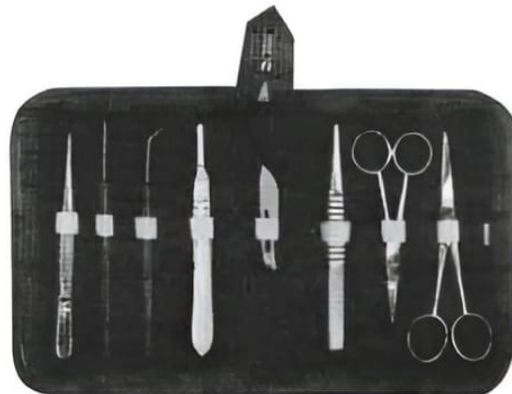

122-0003

- 1- DISSECTING FORCEP 11.5 CM SHARP POINT.
- 2- TEASING NEEDLE SHARP STR.
- 3- BP HANDLE NO 4
- 4- TEASING NEEDLE SHARP ANGULAR
- 5- BLADE NO 22
- 6- THUMB FORCEP T.O.E. 13 CM
- 7- DISSECTING SCISSOR STR 11.5 CM
- 8- DISSECTING SCISSOR STR 13 CM
- 9- ZIPPER CASE INSIDE RED VELVET.



122-0004

- 1- GROOVED DIRECTOR WITH TONGUE TIE 14 CM
- 2- PROBE DOUBLE 14CM
- 3- MAYO HEGAR NEEDLE HOLDER 14 CM
- 4- BP HANDLE NO 3
- 5- BP HANDLE NO 4
- 6- DRESSING SCISSOR 14 CM S/B STR
- 7- DRESSING SCISSOR 14 CM S/B CVD
- 8- DRESSING FORCEP 1/2 TEETH 14 CM
- 9- DRESSING FORCEP SERRATED 14 CM

DISSECTION INSTRUMENTS



- 122-0005**
 1- PROBE DOUBLE 12.5 CM
 2- SCALPEL
 3- B.P. HANDLE NO. 4
 4- 8 PCS BLADE 2 EACH NO. 21, 22, 23
 5- DISSECTING FORCEP 12.5 CM
 6- DISSECTING FORCEP 11.5 CM SHARP POINT
 7- DRESSING SCISSOR S/S STR. 13 CM
 8- DRESSING SCISSOR S/S STR. 13 CM



- 122-0000**
 1- TEASING NEEDLE WITH CHUCK CVD.
 2- HUBER PROBE
 3- IRIS SCISSOR
 4- DISSECTING FORCEP FINE 14 CM.
 5- DISSECTING FORCEP FINE CVD 12 CM.
 6- OPERATING SCISSOR WITH PROBE 14 CM.
 7- B.P. HANDLE NO. 4



- 122-0007**
 1- DISSECTING FORCEP FINE 14 CM.
 2- DISSECTING FORCEP FINE CVD 12 CM.
 3- DISSECTING FORCEP WITH PIN 14 CM.
 4- WATCHMAKER FINE POINT
 5- IRIS SCISSOR STR.
 6- IRIS SCISSOR CVD.
 7- TEASING NEEDLE HOLDER
 8- TEASING NEEDLE STR.
 9- B.P. HANDLE NO. 3



- 122-0008**
 1- TEASING NEEDLE STR.
 2- GROOVED DIRECTOR AND TONGUE TIE.
 3- TEASING NEEDLE CVD
 4- DISSECTING FORCEP WITH PIN 12 CM FINE
 5- OPERATING SCISSOR S/S STR. 14 CM
 6- TRIPLE CHAIN HOOK
 7- PROBE WITH EYE
 8- PROBE DOUBLE END
 9- PROBE AND HOOK
 10- DISSECTING FORCEP FINE 14 CM
 11- IRIS SCISSOR
 12- HUBER PROBE
 13- B.P. HANDLE NO. 3
 14- B.P. HANDLE NO. 4

DISSECTION INSTRUMENTS



122-0009

- 1- PROBE WITH EYE
- 2- DISSECTING FORCEP CVD FINE 12 CM.
- 3- IRIS SCISSOR
- 4- OPERATING SCISSOR SB STR 14 CM
- 5- GROOVED DIRECTOR AND TONGUE TIE
- 6- HUBER PROBE
- 7- TRIPLE CHAIN HOOK
- 8- B.P. HANDLE NO. 4
- 9- B.P. HANDLE NO. 3
- 10- TEASING NEEDLE WITH CHUCK CVD
- 11- TEASING NEEDLE WITH CHUCK STR.
- 12- DISSECTING FORCEPS FINE 14 CM



122-0010

- 1- PROBE DOUBLE END
- 2- GROOVED DIRECTOR AND TONGUE TIE
- 3- B.P. HANDLE NO. 4
- 4- OPERATING SCISSOR STR SB 14 CM.
- 5- KELLY FORCEPS STR 14 CM.
- 6- DISSECTING FORCEPS THUMB 13 CAL.



122-0011

- 1- IRIS SCISSOR STR
- 2- DISSECTING FORCEP CVD FINE 12 CM
- 3- SCALPEL
- 4- TEASING NEEDLE STR WOODEN HANDLE
- 5- TEASING NEEDLE CVD WOODEN HANDLE
- 6- WATO MAKER FINE POINT



122-0012

- 1- DISSECTING FORCEP FINE STR WITH PIN 12 CM
- 2- IRIS SCISSOR STR
- 3- PROBE WITH EYE
- 4- PROBE AND HOOK
- 5- OPERATING SCISSOR SB STR 14 CM
- 6- TRIPLE CHAIN HOOK
- 7- B.P. HANDLE NO. 4
- 8- HUBER PROBE
- 9- B.P. HANDLE NO. 3
- 10- TEASING NEEDLE STR PLASTIC HANDLE
- 11- TEASING NEEDLE CVD PLASTIC HANDLE
- 12- GROOVED DIRECTOR AND TONGUE TIE
- 13- PROBE DOUBLE END

DISSECTION INSTRUMENTS



122-0013

- 1- GROOVED DIRECTOR AND TONGUE TIE
- 2- MAYO HEGAR NEEDLE HOLDER 14 CM
- 3- BP HANDLE NO 4
- 4- DISSECTING FORCEP THUMB 14 CM
- 5- OPERATING SCISSOR S/B STR 14 CM
- 6- KELLY FORCEP 14 CM STR
- 7- PROBE DOUBLE END



122-0014

- 1- DISSECTING FORCEP THUMB 14 CM
- 2- DISSECTING FORCEP 1/2 TEETH 14 CM
- 3- BP HANDLE NO 3
- 4- GROOVED DIRECTOR AND TONGUE TIE
- 5- MAYO HEGAR NEEDLE HOLDER 14 CM
- 6- OPERATING SCISSOR S/B STR 14 CM
- 7- PROBE DOUBLE END
- 8- KELLY FORCEP STR 14 CM



122-0015

- 1- PROBE DOUBLE END
- 2- BP HANDLE NO 4
- 3- DISSECTING FORCEP 1/2 TEETH 14 CM
- 4- OPERATING SCISSOR S/B 14 CM STR
- 5- MAYO HEGAR NEEDLE HOLDER 14 CM
- 6- KELLY FORCEP STR 14 CM
- 7- OPERATING SCISSOR S/B CVD 14 CM
- 8- GROOVED DIRECTOR AND TONGUE TIE
- 9- DISSECTING FORCEP THUMB 14 CM



122-0016

- 1- PROBE DOUBLE END
- 2- DISSECTING FORCEP 1/2 TEETH 14 CM
- 3- KELLY FORCEP CVD 14 CM
- 4- OPERATING SCISSOR S/B 14 CM CVD
- 5- MAYO HEGAR NEEDLE HOLDER 14 CM
- 6- BP HANDLE NO 4
- 7- OPERATING SCISSOR S/B 14 CM STR
- 8- KELLY FORCEP STR 14 CM
- 9- DISSECTING FORCEP THUMB 14 CM
- 10- GROOVED DIRECTOR AND TONGUE TIE

PATIENT CARE ITEMS



123-0001



123-0002



123-0008



123-0007



123-0000



123-0004



123-0003
123-0005

TREATMENT ROOM ITEMS



THANK YOU



SURGIPROVE

SURGICAL EQUIPMENT SUPPLIERS



surgiprove@gmail.com



+923307020002