



SURGIPROVE

SURGICAL SUPPLIERS

surgical/medical instruments



+923307020002



surgiprove@gmail.com



www.surgiprove.com



OUR BIG IDEA

Get top-quality surgical equipment delivered worldwide at unbeatable prices from our company...! We guaranty A grade quality with every purchase.



EQUIPMENT OVERVIEW

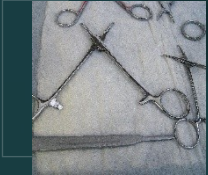

SURGICAL

All types of surgical equipment at unbeatable price

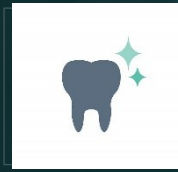

DENTAL

Also work in dental instruments with best quality

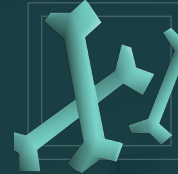

ORTHOPEDICS

We also deal with orthopedics instruments and implants.



VETERINARY

Reliable tools for compassionate pet care.



BEAUTY

Empowering beauty professionals with quality tools

Success

THE MARKET

CUSTOMER SEGMENTATION

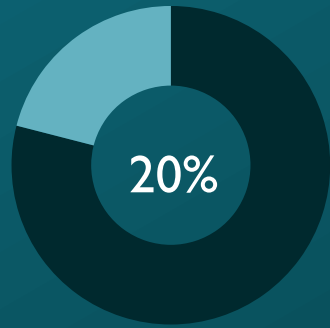

Orthopedic

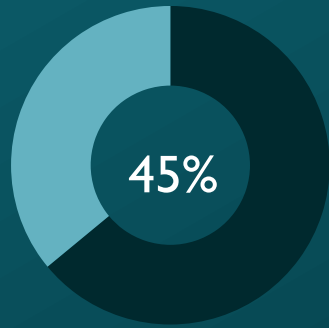

General surgery

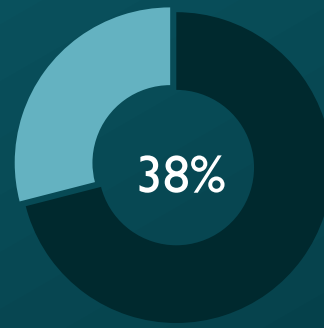

Dental

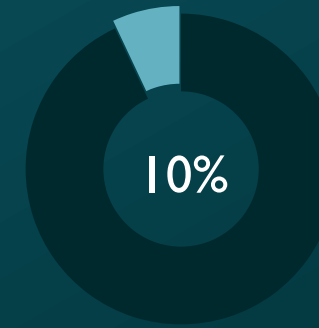

Veterinary

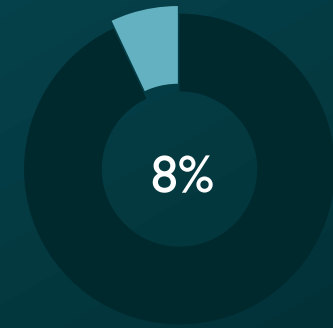

Beauty

Services	YR 1	GROWTH	YR 2	YR 3
Orthopedics instruments	\$230,880	10%	\$253,968	\$279,364
General surgery	\$506,160	8%	\$546,652	\$601,317
Dental equipment	\$44,400	10%	\$48,840	\$53,724
Veterinary	\$115,440	7%	\$123,520	\$132,166
Beauty equipment	\$35,520	5%	\$37,296	\$39,160
TOTAL	\$888,000*	\$70000	\$1,010,276	\$1,105,731

OUR SERVICES



Extended Office Hours

24 Hours available



Pediatric and Family Medical Services

'Trusted medical care for every stage of life'



In-house Delivery

Delivering surgical equipments for a healthier tomorrow.



Call-in Available

"Let us help you find the right equipment for your facility- contact us now"



Surplus Medical Supplies

"Gently used surgical equipment for sale- certified and tested"

IN-DEMAND SERVICES



General Surgery

- Essential tools for modern surgeons.
- Empowering surgeons with top-tier equipment for exceptional patient outcomes.
- High-demand equipment for precise procedures..



Ortho spine

- Precision Ortho Spine solutions for optimal patient care.
- Transforming spine surgery with innovative, in-demand equipment for superior outcomes.
- High-performance equipment for Ortho Spine specialists.



Neurosurgery

- Advanced neurosurgery equipment for delicate procedures.
- Innovative Neurosurgery Solutions, illuminating the path to better outcomes.
- Expert care for the most complex cases, trusted Neurosurgery equipment for superior results.

SALES FORECAST

3 YEAR SALES FORECAST

3 YEAR SALES SUMMARY	YR1	YR2	YR3
TOTAL SALES	\$888,000	\$1,065,600	\$1,278,720
TOTAL COGS	\$634,824	\$666,565	\$699,893
NET PROFIT	\$253,176	\$549,600	\$578,827

Annual Sales & Gross Profit

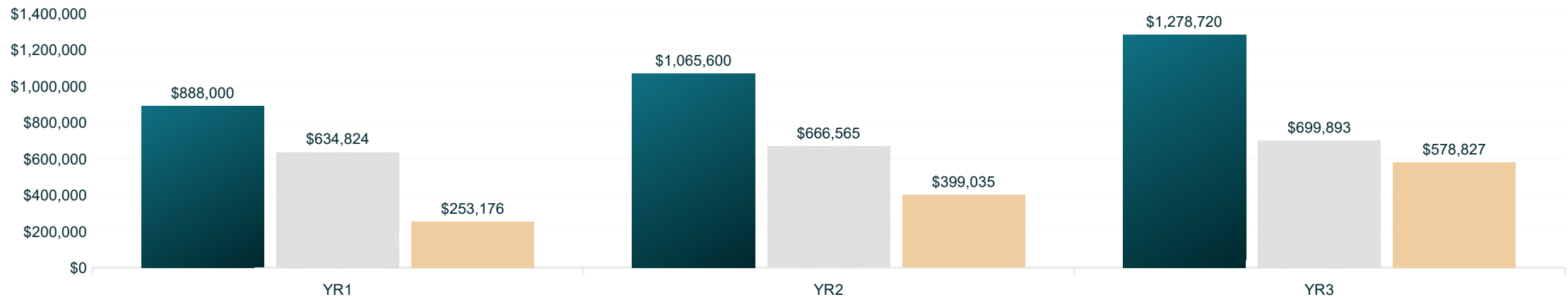



DIAGNOSTIC SET

DIAGNOSTIC SET

(ENT COMPLETE) ✓

101-0001

Consisting of Battery Handle (without battery)

3 Ear specula, 1 Nasal specula, 2 Laryngeal mirrors with holder

1 tongue depressor holder, 1 Bulb



OTOSCOPE
SET

OTOSCOPE SET

101-0002

Consisting of Battery Handel (without
battery) 3 Ear Specula, 1Bulb

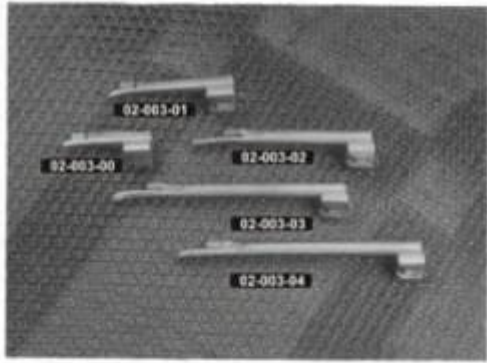

MILLER

MILLER

101-0003

Laryngoscope Set

CATHETER FORCEPS & LARYNGOSCOPE

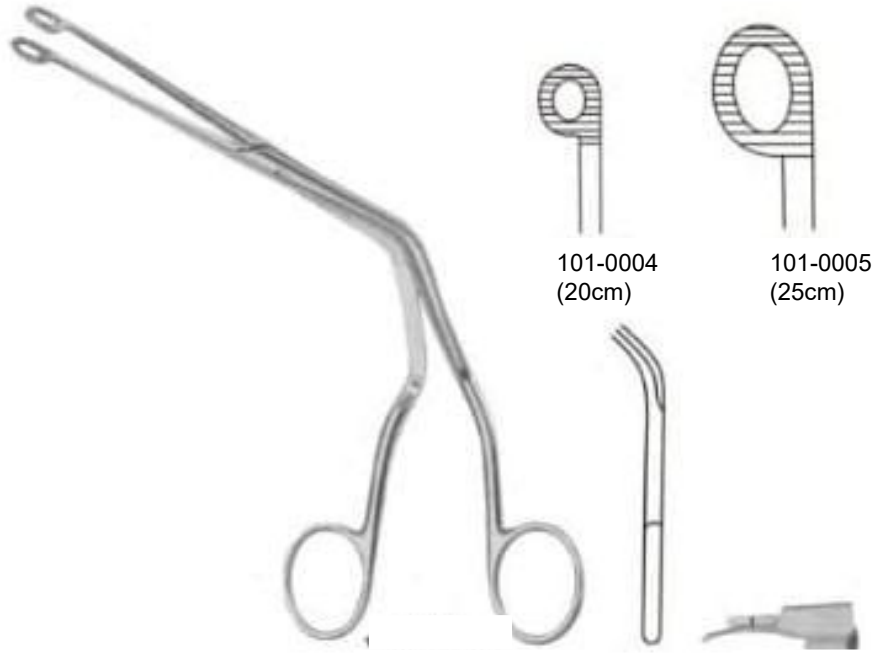

101-0004
(20cm)

101-0005
(25cm)

Magill
101-0004to101-0005

101-0007

101-0008

101-0009

101-00010

101-00011



Mcintosh laryngoscope Set
101-0006

Mcintosh

SURGICAL HANDLES



NO.3L 102-0001
ERGONOMIC NO.7 102-0002
NO.7 102-0003

102-0004
102-0005
102-0006

 +923307020002

 surgiprove@gmail.com

 www.surgiprove.com

SURGICAL HANDLES

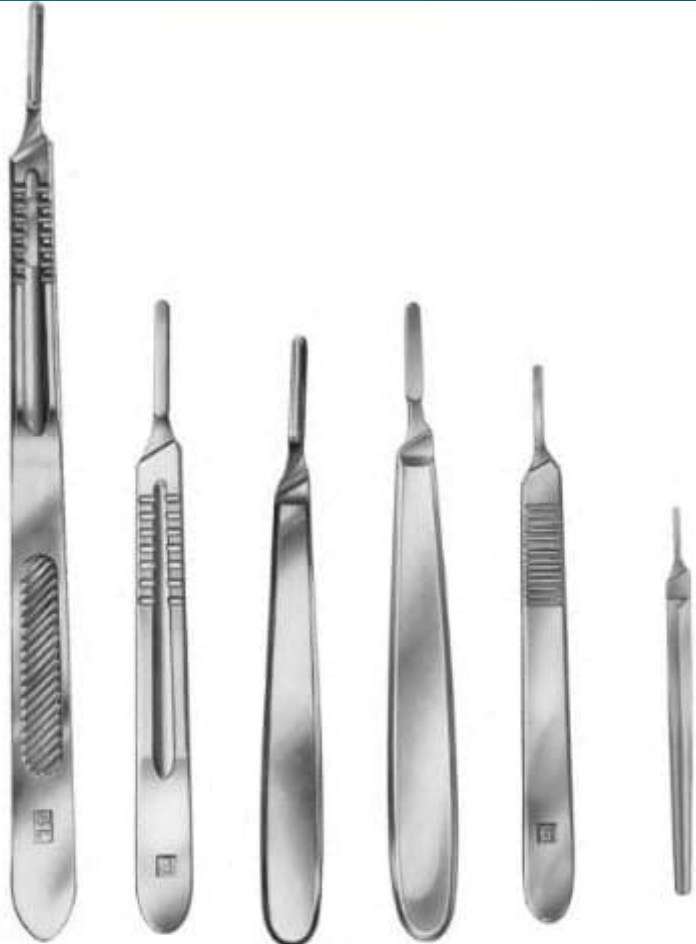

NO.4L 102-0007
NO.4 102-0008
NO.10 102-0009
NO.9 102-0010
NO.3 102-0011

BARRON 102-0012
For 'B.P.' types blades for use
with NO'S 10,11,12 &15 blades
135mm (5.1/4")

SCISSORS

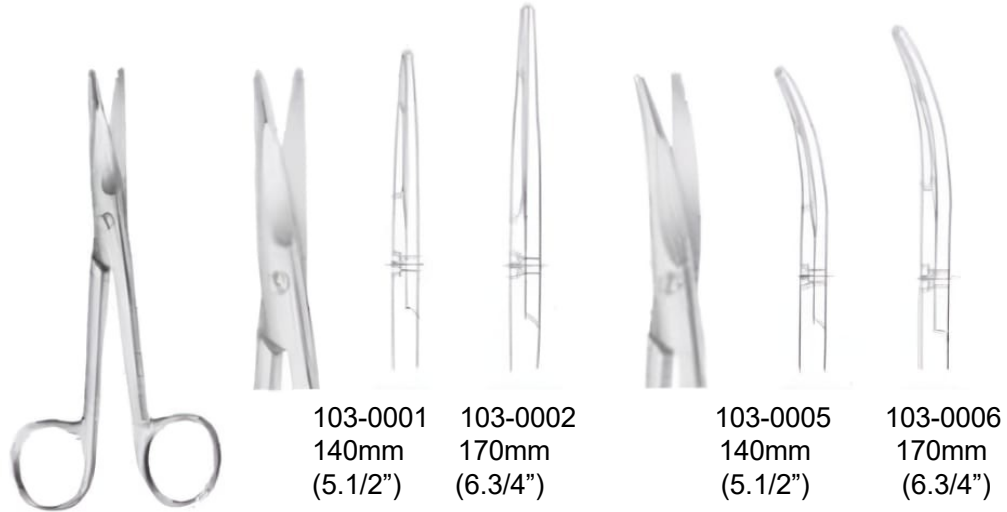

MAYO
Straight, beveled blades

103-0001 140mm (5.1/2")	103-0002 170mm (6.3/4")	103-0005 140mm (5.1/2")	103-0006 170mm (6.3/4")
103-0003 190mm (7.1/2")	103-0004 215mm (8.1/2")	103-0007 190mm (7.1/2")	103-0008 215mm (8.1/2")

Curved on flat, beveled blades

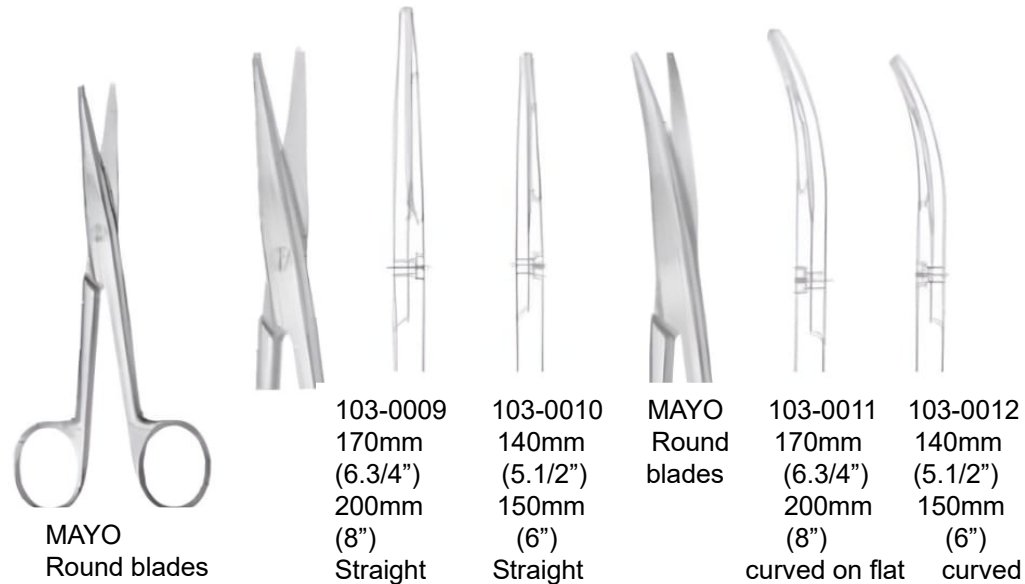

MAYO
Round blades

103-0009 170mm (6.3/4")	103-0010 140mm (5.1/2")	MAYO Round blades	103-0011 170mm (6.3/4")	103-0012 140mm (5.1/2")
200mm (8")	150mm (6")		200mm (8")	150mm (6")
Straight	Straight		curved on flat	curved on flat

SCISSORS

Curved on flat, blunt points

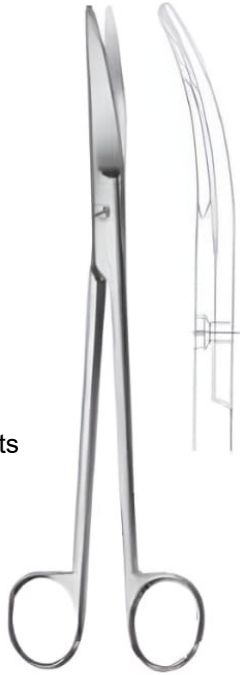

MAYO HARRINGTON
103-0013
225MM(9")

Straight, blunt points



MAYO HARRINGTON
103-0014
225mm (9")



MAYO
(STILLE)



103-0015
170mm
(6.3/4")
Straight

103-0016
150mm
(6")
Straight



103-0017
170mm
(6.3/4")
Curved on flat

103-0018
150mm
(6")
Curved on flat



+923307020002



surgiprove@gmail.com



www.surgiprove.com

SCISSORS



METZENBAUM



METZENBAUM

Straight, blunt points
 103-0019 115mm (4.1/2")
 103-0020 145mm (5.3/4")
 103-0021 180mm (7")
 103-0022 220mm (8")

METZENBAUM (NELSON)

Straight
 103-0023 230mm (9")
 103-0024 250mm (10")



METZENBAUM

Curved on flat, blunt points
 103-0025 115mm (4.1/2")
 103-0026 145mm (5.3/4")
 103-0027 180mm (7")
 103-0028 200mm (8")

METZENBAUM (NELSON)

Curved on flat
 103-0029 230mm (9")
 103-0030 250mm (10")



DRESSING

Straight, blunt/ blunt points
 103-0031 125mm (5")
 103-0032 145mm (5.3/4")
 103-0033 150mm (6")
 103-0034 180mm (7")
 103-0035 200mm (8")



DRESSING

Straight, sharp/ blunt points
 103-0036 125mm (5")
 103-0037 145mm (5.3/4")
 103-0038 150mm (6")
 103-0039 180mm (7")
 103-0040 200mm (8")



DRESSING

Straight, Sharp/ Sharp points
 103-0041 125mm (5")
 103-0042 145mm (5.3/4")
 103-0043 150mm (6")
 103-0044 180mm (7")
 103-0045 200mm (8")



SCISSORS



CRAFOORD
103-0046
305mm (12")
Straight



LLOYD DAVIS RECTAL
blunt points, flat blades
103-0047 255mm(10")
Curved on flat
103-0048 255mm (10")
Straight

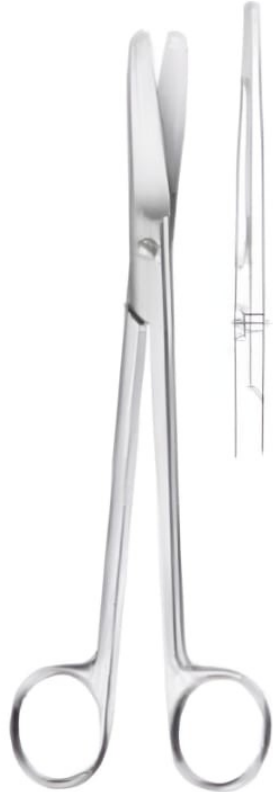

UTERINE
103-0049
230mm(9")
Straight, blunt
points



UTERINE
Curved on flat, blunt points
103-0050 200mm
(8")
103-0051 230mm
(9")

SCISSORS



**BRAUN STADTLER
EPISIOTOMY angled**
Blades.
103-0052
145mm (5.3/4")
103-0053
200mm (8")



**AMERICAN PATTERN
UMBILICAL angled**
Blades.
103-0054
100mm
(4")



HEGEMANN'S DELICATE
190mm (7.1/2")

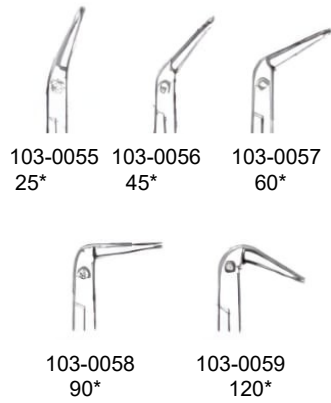

KLINER
103-0060
110mm (4.1/2")
Straight, sharp points
103-0061
110mm (4.1/2")
Curved on flat, blunt
points



AUFRICHT
150mm (6") Light weight
103-0062 Straight
103-0063 curved on flat

DELICATE SCISSORS



IRIS
110mm (4.1/2")
Sharp points

103-0064 Straight
103-0065 Curved on flat



IRIS
110mm (4.1/2")
Round blades
Sharp points

103-0066 Straight
103-0067 Curved on flat



IRIS
103-0068 90mm
(3.1/2")
Curved on flat,
lightweight sharp points.



STRABISMUS
103-0069 110mm
(4.1/2") Straight
103-0070 110mm
(4.1/2")
Curved on flat



HEYMAN TURBINECTOMY
103-0071 185MM (7.1/4")
Angled shanks blunt points

DELICATE & ORAL SCISSORS



STEVENS TENOTOMY
110mm (4.1/4")



103-0072
Straight,
Sharp points



103-0073
Curved on flat
Sharp points



103-0074
Straight,
blunt points



103-0075
Curved on flat
blunt points



**SCHUKNECHT
WIRE CUTTING**
103-0076 125mm (5")



WOOD TONSILS
190mm (7.1/2")

103-0077
Curved on flat
sharpened
outer edge, blunt



WHEELER TONSILS
103-0078 250mm (8")
Curved on flat



WILSON TONSIL
103-0079 180mm (7")
Straight

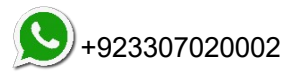

+923307020002



surgiprove@gmail.com



www.surgiprove.com

SCISSORS

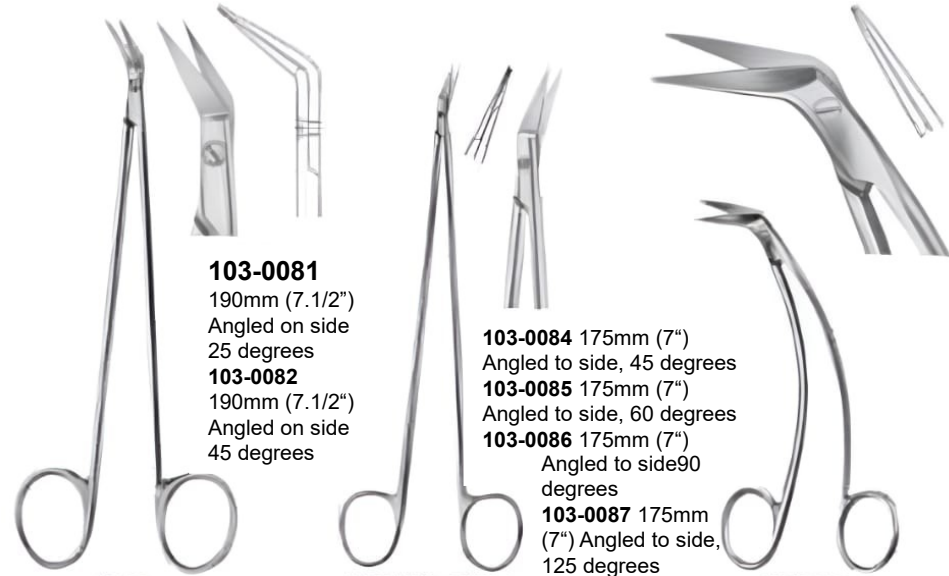

103-0081
190mm (7.1/2")
Angled on side
25 degrees
103-0082
190mm (7.1/2")
Angled on side
45 degrees

103-0084 175mm (7")
Angled to side, 45 degrees
103-0085 175mm (7")
Angled to side, 60 degrees
103-0086 175mm (7")
Angled to side 90
degrees
103-0087 175mm
(7") Angled to side,
125 degrees

FAVALORO 103-0088 150mm (6")
Shanks curved, Blades angled to side

POTTS
103-0080 190mm
(7.1/2")
Angled on flat 45
degrees

HEDGEMAN (DIETRICH)
103-0083 175mm (7")
Angled to side, 25 degrees



DOYEN ABDOMINAL
103-0089 180mm(7")
Curved, blunt points



DOYEN ABDOMINAL
103-0090 180mm(7")
Straight, blunt points



DOYEN ABDOMINAL
103-0091 210mm(8.1/4")
one blade with hook end



COUNTER SCISSORS
103-0092 210mm (8.1/4")

SCISSORS



REYNOLDS
Curved on flat,
tapered points

103-0093 145mm
(5.3/4")
103-0094 180mm
(7")

103-0095 115mm(4.1/2")
103-0096 140mm(5.1/2")
103-0097 180mm (7")
103-0098 200mm (8")
103-0099 235mm (9.1/4")



LISTER BANDAGEz



SCHUMACHER UMBILICAL
103-0100 155mm (6")



MCINDOE SCISSORS
103-0101 180mm(7")
Straight

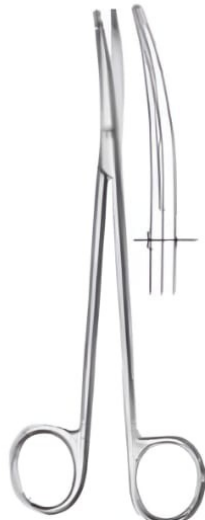

MCINODE SCISSORS
103-0102 180mm(7")
Curved

SERRATED DISSECTING FORCEPS



CANADIAN
straight
104-0001
130mm(5.1/8")
104-0002
150mm (6")



**DISSECTING
FORCEPS**
Turn over end
104-0003 125mm (5")
104-0004 150mm (6")
104-0005 180mm (7")
104-0006 200mm (8")
104-0007 250mm (10")



**DISSECTING
FORCEPS**
Block end
104-0008 125mm(5")
104-0009 150mm(6")
104-0010 180mm(7")
104-0011 200mm(8")
104-0012 250mm(10")



**DISSECTING
FORCEPS**



104-0013
150mm
(6")



104-0014
180mm
(7")



104-0015
200mm
(8")



**DISSECTING
FORCEPS**



104-0016
115mm
(4.1/2")



104-0017
130mm
(5.1/8")



104-0019
160mm
(6.1/4")



**DISSECTING
FORCEPS**
Round points



104-0021
115mm
(4.1/2")



104-0022
130mm
(5.1/8")



104-0023
150mm
(6")



104-0024
160mm
(6.1/4")



104-0025
180mm
(7")



104-0026
200mm
(8")



104-0027
250mm
(10")



104-0028
300mm
(12")

SERRATED DISSECTING FORCEPS



RAMSEY
104-00029
180mm(7")



BONNEY
104-0030
180mm(7")



BICKFORD
104-0031
225mm(9")



MAINGOT
INTESTINAL
Fenestrated grip
104-0032
280mm(11")



ST MARKS
104-0033
290mm(11.1/2")



EMMET
104-00034
200mm(8")



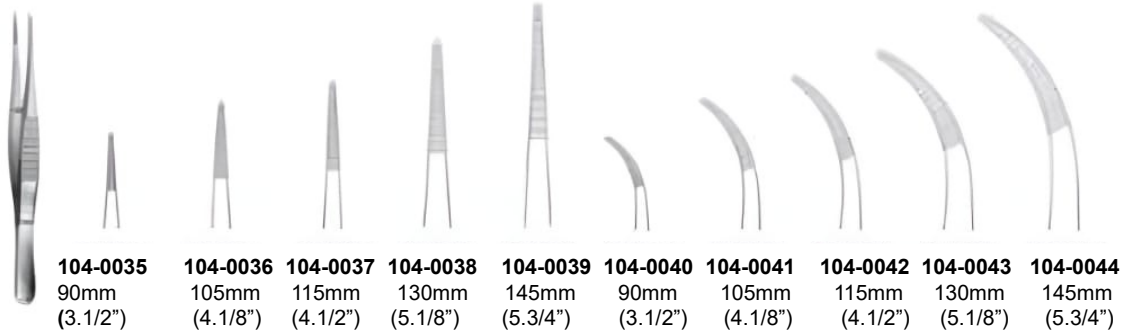

DELICATE DISSECTING FORCEPS

MACINDOE
104-0045
150mm(6")

WAUGH
104-0046
200mm(8")

WAUGH

104-0047
150mm(6")
104-0048
180mm(7")

ADSON

104-0049
125mm(6")
Fine
104-0050
125mm(5")
Standard
104-0051
190mm(7.1/2")

CAIRNS(DOTT)



104-0052
215mm(8.1/2")
Medium jaw
2mm wide

104-0053
180mm(7")
Fine jaw
1mm wide

DELICATE DISSECTING FORCEPS



TREVES
½ teeth

- 104-0054**
125mm(5")
- 104-0055**
150mm(6")
- 104-0056**
180mm(7")
- 104-0057**
200mm(8")
- 104-0058**
250mm(10")



LANE
½ teeth

- 104-0059**
125mm(5")
- 104-0060**
145mm(5.3/4")
- 104-0061**
180mm(7")
- LANE**
2/3 TEETH
- 104-0062**
145mm(5.3/4")
- 104-0063**
180mm(7")



DISSECTING FORCEPS

- 104-0064**
150mm(6") 2/3 teeth
- 104-0065**
150mm(6") ¾ teeth



WAUGH
½ teeth

- 104-0066**
200mm(8")
- 104-0067**
180mm(7")
- 104-0068**
150mm(6")



ADSON
½ teeth

- 104-0069**
125mm(5") Fine
- 104-0070**
125mm(5") Standard
- 104-0071**
190mm(7.1/2")



ADSON
Bayont
½ teeth

- 104-0072**
190mm
(7.1/2")



JEFFERSON
½ teeth

- 104-0073**
180mm(7")



ADSON-BROWN
7/7 teeth



- 104-0074**
125mm
(5")



PENNYBACKER
¾ teeth
104-0075 160mm(6.1/2")



+923307020002



surgiprove@gmail.com



www.surgiprove.com

TOOTHED DISSECTING FORCEPS

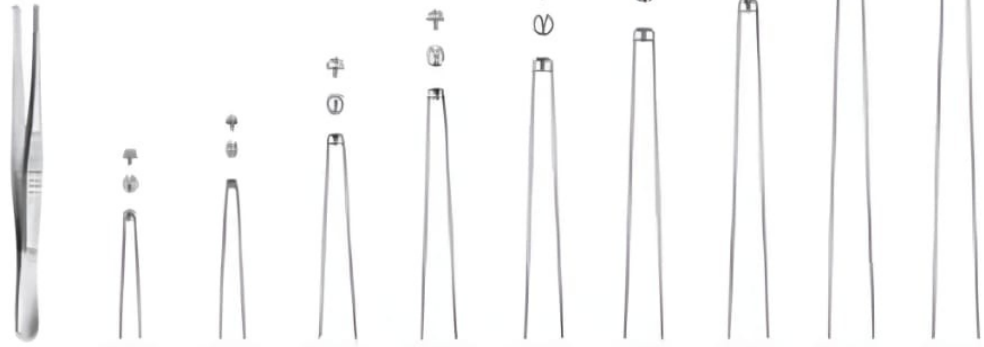

104-0076	104-0077	104-0078	104-0079	104-0080	104-0081	104-0082	104-0083	104-0084
105mm	115mm	130mm	150mm	160mm	180mm	200mm	250mm	300mm
(4.1/8")	(4.1/2")	(5.1/8")	(6")	(6.1/4")	(7")	(8")	(10")	(12")

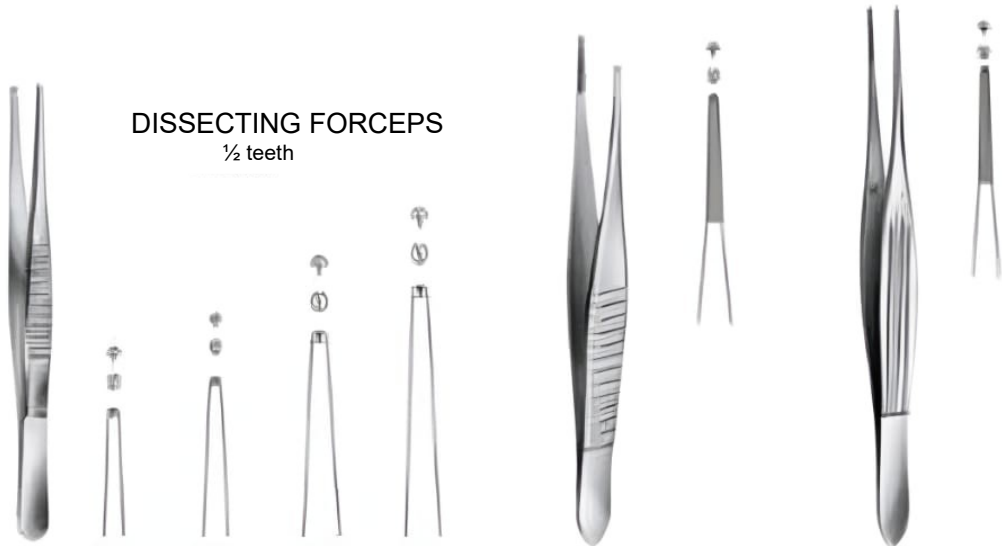

DISSECTING FORCEPS
1/2 teeth

104-0085	104-0086	104-0087	104-0088
115mm	130mm	145mm	160mm
(4.1/2")	(5.1/8")	(5.3/4")	(6.1/4")

GILLIES
104-0089
150mm(6")
1/2 teeth

MICINDOE
104-0090
150mm(6")
1/2 teeth

TOOTHED DISSECTING FORCEPS

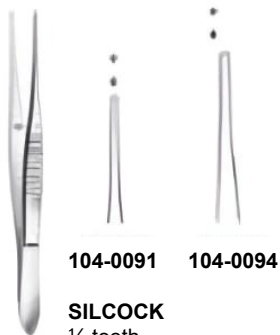

104-0091 104-0094

SILCOCK
½ teeth

104-0092
100mm(4")
104-0093
110mm(4.3/8")

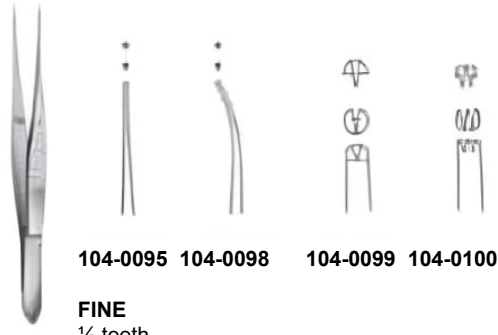

104-0095 104-0098 104-0099 104-0100

FINE
½ teeth
104-0096
100mm(4")
104-0097
100mm(4")



RAMSEY
180mm(7")



BONNY
½ teeth

104-0101
180mm(7")



BICKFORD
½ teeth

104-0102
255mm(9")



CANADIAN
2/3 teeth

104-0103
140mm(5.1/2")

104-0104
150mm(6")

TOOTHED DISSECTING FORCEPS



ST MARKS
½ teeth

104-0105
290mm(11.1/2")



**JACKSON
BURROWS**
½ teeth

104-0107
140mm(5.1/2")

OFFICER
4/5 teeth

104-0106
150mm(6")



RUSSIAN
With circular jaw

104-0109
150mm(6")
104-0110
200mm (8")
104-0111
250mm(10")



**NELSON LUNG
ADHESION**

104-0112
230mm(9")



MUSTARDE
Combined, double hooked jaw
104-0108
150mm(6")

SPLINTER FORCEPS



**104-0113
ARTHURE**
140mm(5.1/2")



**104-0114
FEILCHENFEL**
70mm(3")
90mm(3.1/2")
115mm(4.1/2")



**104-0115
HUNTER**
105mm
(4.1/8")



**DENIS BROWNE
104-0016**
190mm(7.1/2")



MICRO SOFT TOUCH RING TIP
104-0117
150mm(6")
104-0118
185mm(7.1/4")
104-0119
210mm(8.1/4")
104-0120
230mm(9")
104-0121
250mm(10")



Troeltsch (wild)
104-0122
110mm(4.1/2")



**TUDICHUM
104-0124**
65mm

TROELTSCH(Wilde)
104-0123
120mm(4.3/4")

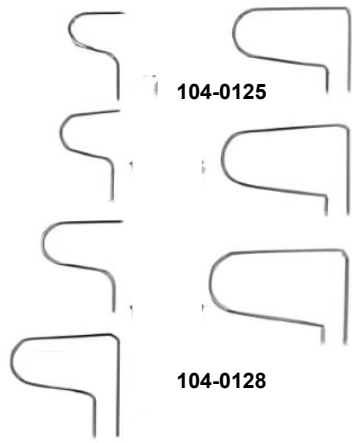

104-0125

104-0126

104-0127

104-0128

DISSECTING & LIGATURE FORCEPS



LIGATURE FORCEPS
105-0001
95mm(3.3/4")
Straight, smooth jaw



MICRO ADSON
105-0002
140mm(5.1/2")

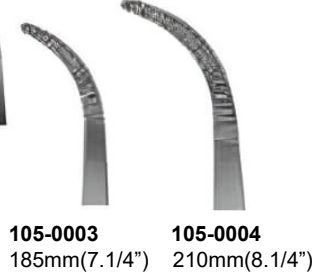

105-0003 185mm(7.1/4")
105-0004 210mm(8.1/4")

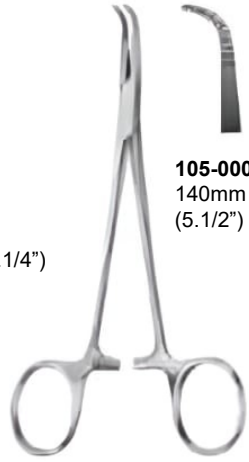

BABY ADSON

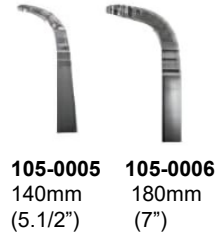

105-0005 140mm
(5.1/2")
105-0006 180mm
(7")



FINE CURVED
DISSECTING FORCEPS

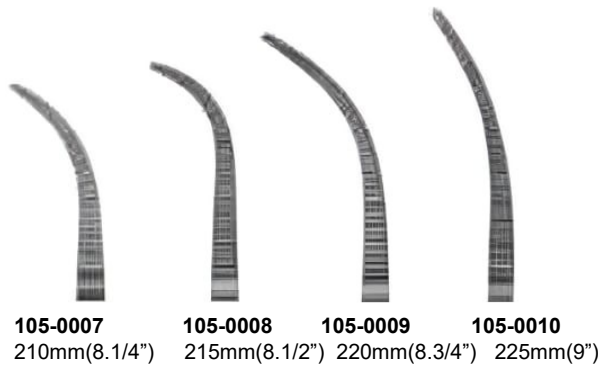

105-0007 210mm(8.1/4")
105-0008 215mm(8.1/2")
105-0009 220mm(8.3/4")
105-0010 225mm(9")

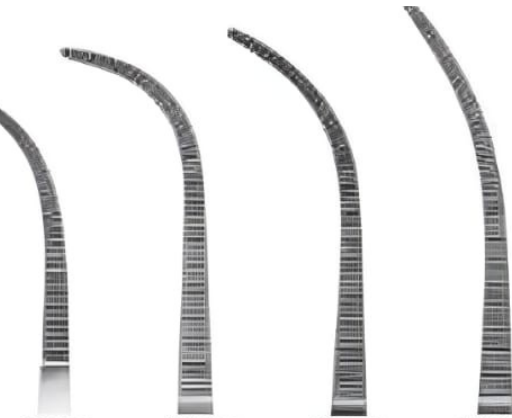

105-0011 225mm(9")
105-0012 295mm(11.3/4")
105-0013 295mm(11.3/4")
105-0014 300mm(12")



S. SHAPED DELICATE

DISSECTING & LIGATURE FORCEPS



MIXTER
105-0015
200mm
(8")



LAWRENCE
105-0016
270mm
(10.3/4")



105-0017
300mm(12")

105-0018
290mm (11.1/2")



TISSUE FORCEPS



RUTHERFORD MORISON
105-0019 150mm(6")
 6/7 teeth



STILES(ALLIS-THOMAS)
105-0020 200mm(8")
 6/7 teeth

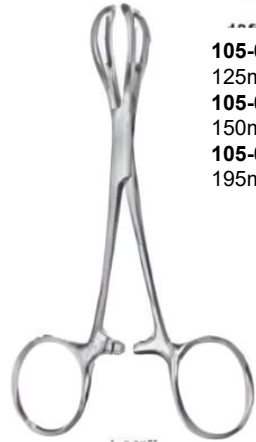

LANE 1/2 teeth fenestrated

- 105-0021**
125mm(6")
- 105-0022**
150mm(6")
- 105-0023**
195mm(7.3/4")



BABCOCK
105-0024 165mm(6.1/2")



BABCOCK 105-0025
 200mm (8") Extra light



BABCOCK
105-0025 230mm(9")

TISSUE FORCEPS



105-0032

105-0033



AMERICAN PATTERN ALLIS 105-0034 105mm

ALLIS
150mm (6")
105-0027 2/3 teeth
105-0028 3/4 teeth
105-0029 4/5 teeth
105-0030 5/6 teeth
105-0031 6/7 teeth

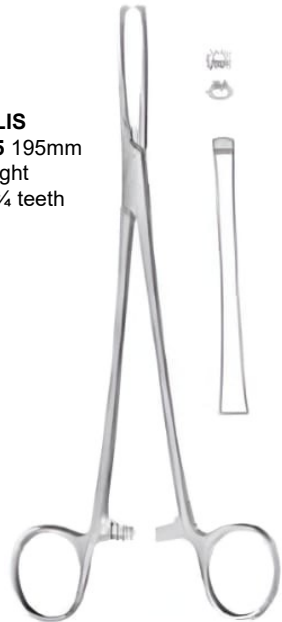

JUD-ALLIS
105-0035 195mm
(7.3/4") light
pattern, 3/4 teeth



CHAPUT (POIRIER) 105-0036
125mm (5") 2/3 teeth

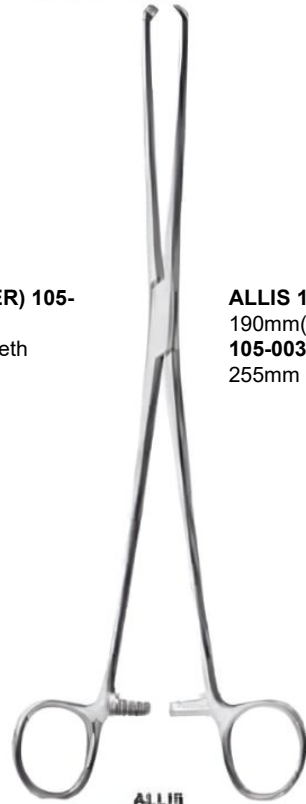

ALLIS 105-0037
190mm (7.1/2")
105-0038
255mm (10") 5/6 teeth

MOUTH GAGS

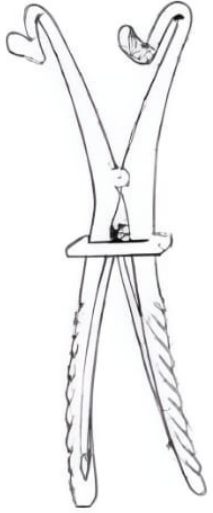

FERGUSSON ACLAND
105-0039
170mm(6.3/4")

105-0040
200mm(8")



DOYEN(CHILD)
105-0041
120mm(4.3/4")



FEATHERSTONE
105-0042
165mm(6.1/2")



DOYEN(ADULT)
105-0043
140mm(5.1/2")



FLAT TONGUE DEPRESSOR
Double ended tapering
19mm+23mm

105-0044
180mm(7")



105-0045
140mm(5.1/2")



LACK TONGUE DEPRESSOR
105-0046 13mm wide child
105-0047 19mm wide Adolescent
105-0048 22mm wide Adults

TONGUE DEPRESSORS

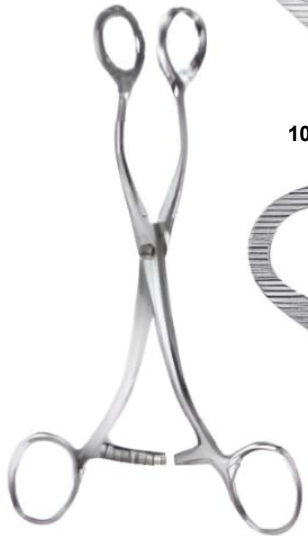

COLIN TONGUE FORCEPS
105-0049 170mm(6.3/4")
105-0050 160mm(6 1/4")



105-0051



105-0052



HEYWOOD-SMITH TONGUE FORCEPS
105-0053 200mm(8")

TOWEL CLAMPS



ROBIN

105-0054 140mm(5, 1/2")
Holder diameter 5mm
105-0055 140mm holder
diameter 13mm **1050056**
140mm holder diameter 25mm



EDNA(LORNA)
105-0057
100mm(4")



EDNA(LORNA)
105-0058
130mm(5. 1/4")



DOYEN
105-0059
190mm(7. 1/2")



BALL AND SOCKET
105-0062 130mm(5")

105-0060
90mm(3. 1/2")



BACKHAUS

105-0063



MAYO 105-0064
140mm (5, 1/2")

105-0061

100mm(4.3/4")



MOYNIHAN 105-0065
190mm (7. 1/2") 2/2 teeth

SPONGE HOLDING FORCEPS



RAMPLEY

105-0066
180mm(7")

105-0067
240mm (9.1/2")



FORESTER

105-0068
240mm(9.1/2")

105-0069
180mm (7") Straight

105-0070
240mm (9.1/2")

105-0071
180mm (7") Curved
on flat



105-0072



105-0073



105-0074



105-0075

DRESSING FORCEPS



**BOZEMANN UTERINE
DRESSING FORCEPS
105-0076** 255mm(10")
Jaws with longitudinal
groove



BOZEMANN 105-0077
260mm(10.1/4") Serrated
jaws, on large bow



BOZEMANN 105-0078
250mm(10') S-shaped
curve



LISTER-SINUS



105-0079
125mm(5")



105-0080
150mm(6")



105-0081
180mm(7")

HAEMOSTATS FORCEPS



HALSTEAD MOSQUITO
106-0001 100mm(4")
Straight



HALSTEAD MOSQUITO
106-0002 100mm(4")
Curved on flat



HALSTEAD MOSQUITO
100mm(4") ½ teeth
106-0003 Straight
106-0004 Curved on flat



HALSTEAD MOSQUITO
125mm(5")
106-0005 Straight
106-0006 Curved on flat



HALSTEAD MOSQUITO
125mm(5") ½ teeth
106-0007 Straight
106-0008 Curved on flat



BABY-CRILE
106-0009
140mm(5.1/2")
Straight

HAEMOSTATS FORCEPS



BABY-CRILE
106-0010 140mm(5.1/2")
Curved on flat



BABY-CRILE
106-0011 140mm (5.1/2")
Straight 1/2 teeth



BABY-CRILE
106-0012 140mm(5.1/2")
Curved on flat 1/2 teeth



HALSTEAD MOSQUITO
125mm(5")
106-0013 Straight
106-0014 Curved on flat



HALSTEAD MOSQUITO
125mm (5") 1/2 teeth
106-0015 Straight
106-0016 Curved on flat

HAEMOSTATS FORCEPS

106-0017
145mm(5.3/4")
106-0018
180mm(7")



**GREY
TURNER**

106-0019 145mm
(5.3/4")
106-0020 180mm
(7")

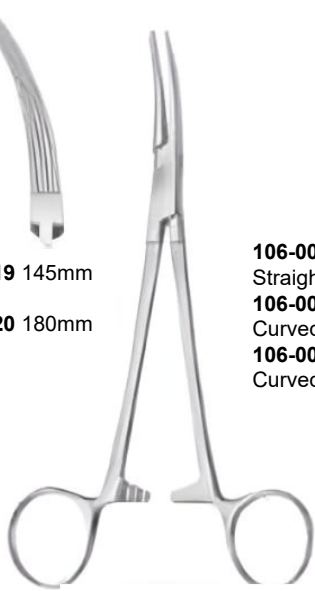

GREY TURNER
Curved on flat

106-0021 145mm(5.3/4")
Straight
106-0022 145mm(5.3/4")
Curved on flat
106-0023 145mm(5.3/4")
Curved to side

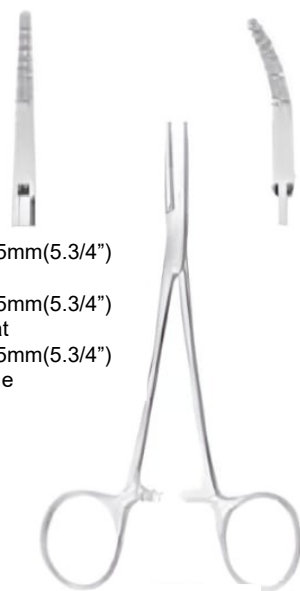

CUSHING

106-0024
254mm(9.3/4")
Curved on flat



CRAFOORD

106-0025
140mm(5.1/2")
106-0026
160mm(6.1/4")
106-0027
180mm (7")

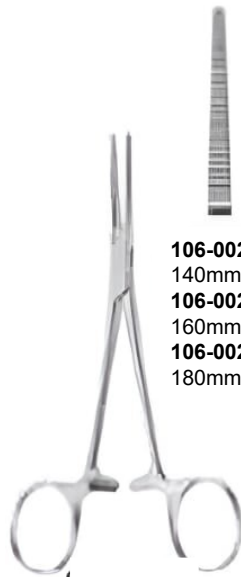

CRILE
Straight

106-0028 145mm(5.3/4")
106-0029 145mm (5.3/4") Curved on flat
106-0030 145mm(5.3/4") Curved to side



CARINS

HAEMOSTATS FORCEPS



CRILE 1/2 teeth **106-0031** 160mm (6.1/4") Straight
106-0032 160mm(6.1/4") Curved on flat
106-0033 140mm (5.1/2") Straight
106-0034 140mm (5.1/2") Curved on flat



CRILE Curved on flat **106-0035**
 140mm (5.1/2")
106-0036 160mm (6.1/4")



KELLY-CRILE straight **106-0037** 140mm (5.1/2")
106-0038 160mm (6.1/4")



KELLY
 Curved on flat
106-0039 140mm (5.1/2")
106-0040 160mm (6.1/4")



KELLY HALSTEAD
106-0041 140mm(5.1/2") Straight
106-0042 140mm (5.1/2") Curved on flat



KOCHER
 Straight 1/2 teeth **106-0043** 125mm (5")
106-0044 140mm (5.1/2")
106-0045 150mm (6")
106-0046 180mm (7")
106-0047 200mm (8")
106-0048 225mm (9")

HAEMOSTATS FORCEPS



KOCHER Curved on flat ½ teeth
106-0049 125mm (5")
106-0050 140mm (5.1/2")
106-0051 150mm (6")
106-0052 180mm (7")
106-0053 200mm (8")
106-0054 225mm (9")

106-0055
 260mm (10.1/4")
 Curved on flat



MAYO
106-0056
 160mm
 Curved on flat



**LLOYD
 DAVIS**



ROCHESTER-OSCHNER
 Straight ½ teeth

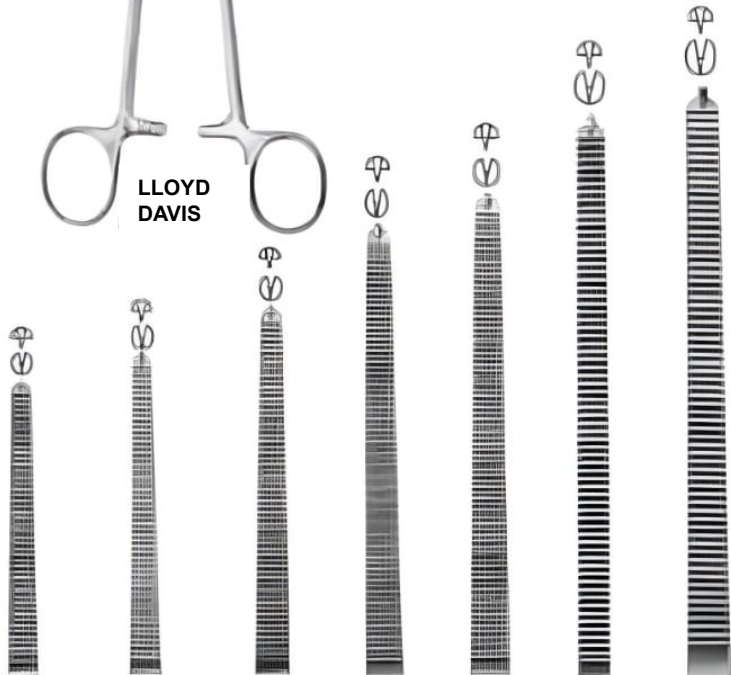

106-0057 140mm(5.1/2") **106-0058** 160mm(6.1/4") **106-0059** 185mm(7.1/4") **106-0060** 200mm(8") **106-0061** 225mm(9") **106-0062** 240mm(9.1/2") **106-0063** 260mm(10.1/4")

HAEMOSTATS FORCEPS



ROCHESTER-OSCHNER
Curved ½ teeth

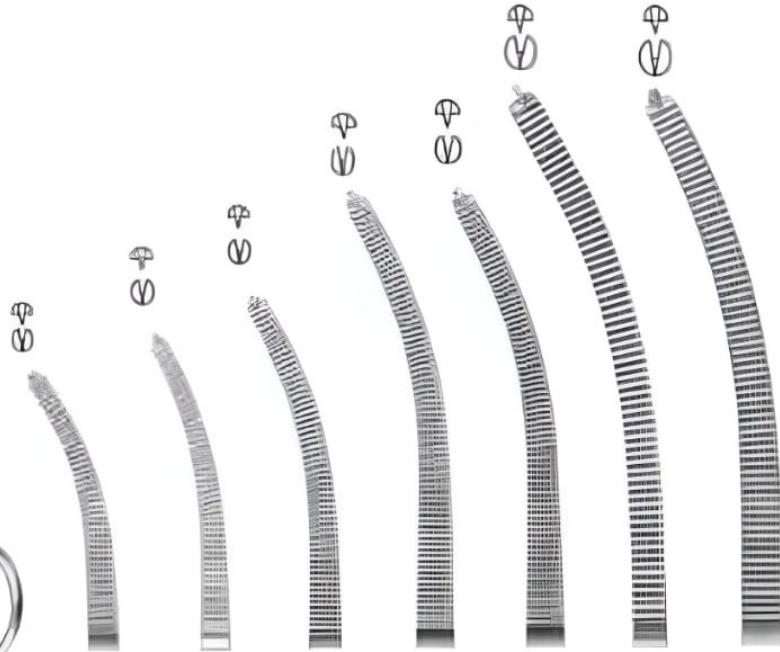

106-0064	106-0065	106-0066	106-0067	106-0068	106-0069	106-0070
140mm (5.1/2")	160mm (6.1/4")	185mm (7.1/4")	200mm (8")	225mm (9")	240mm (9.1/2")	260mm (10.11/4")



FRASER-KELLY(CRILE)
106-0071 180mm(7") Curved on flat

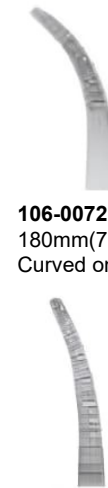

106-0072
180mm(7")
Curved on flat



106-0073
180mm(7")
Straight

106-0074
185mm(7.1/4")
Curved on flat
½ teeth

106-0075
185mm
(7.1/4")
Straight
½ teeth



**FRASER
ADSON**



DUNHILL
106-0076 125mm(5") Curved on flat
106-0077 125mm(5") Straight
106-0078 180mm(7") Curved on flat

HÆMOSTATS FORCEPS



SPENCER WELLS
Straight

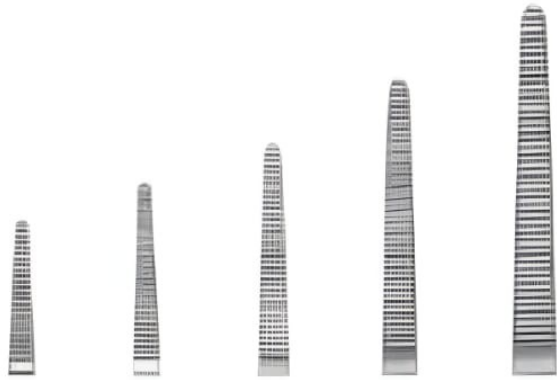

106-0079 125mm (5")	106-0080 150mm (6")	106-0081 180mm (7")	106-0082 200mm (8")	106-0083 225mm (9")
----------------------------------	----------------------------------	----------------------------------	----------------------------------	----------------------------------



106-0084 125mm (5")	106-0085 150mm (6")	106-0086 180mm (7")	106-0087 200mm (8")	106-0088 225mm (9")
----------------------------------	----------------------------------	----------------------------------	----------------------------------	----------------------------------

SPENCER WELLS
Curved on flat

HAEMOSTATS FORCEPS



HEISS 106-0103

200mm(8") Straight

106-0104 200mm(8") Curved on side

106-0105 200mm(8") Straight ½ teeth

106-0106 200mm(8") Curved on flat ½ teeth



ROBERTS Curved on flat

106-0107 230mm(9") Screw joint

106-0108 230mm(9") Box joint



106-0109

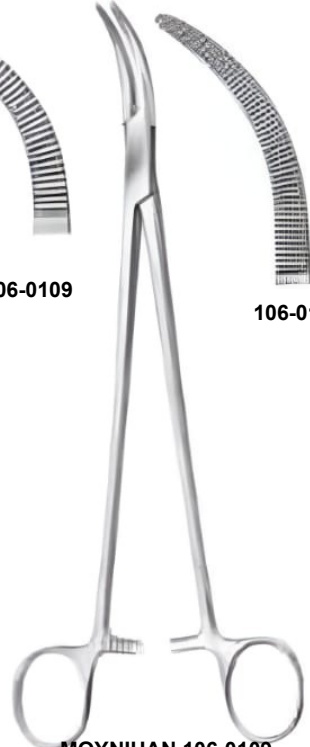

MOYNIHAN 106-0109

230mm(9")

106-0110 240mm (9.1/2")

106-0110

MIXTER

Curved on flat



106-0111

140mm(5.1/2")



106-0112

230mm (9")



BIRKETT

106-0114 180mm(7") Straight

106-0115 180mm(7") Curved to side

106-0116 180mm(7") Curved on flat

HAEMOSTATS FORCEPS



ROCHSTER PEAN
Straight

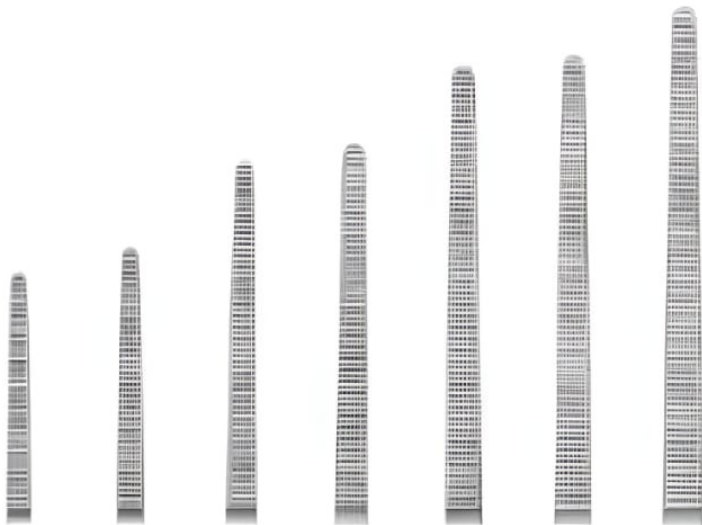

- | | | | | | | |
|--------------------------------------|--------------------------------------|--------------------------------------|----------------------------------|----------------------------------|--------------------------------------|---------------------------------------|
| 106-0089
140mm
(5.1/2") | 106-0090
160mm
(6.1/4") | 106-0091
185mm
(7.1/4") | 106-0092
200mm
(8") | 106-0093
225mm
(9") | 106-0094
240mm
(9.1/2") | 106-0095
260mm
(10.1/4") |
|--------------------------------------|--------------------------------------|--------------------------------------|----------------------------------|----------------------------------|--------------------------------------|---------------------------------------|



- | | | | | | | |
|--------------------------------------|--------------------------------------|--------------------------------------|----------------------------------|----------------------------------|--------------------------------------|---------------------------------------|
| 106-0096
140mm
(5.1/2") | 106-0097
160mm
(6.1/4") | 106-0098
185mm
(7.1/4") | 106-0099
200mm
(8") | 106-0100
225mm
(9") | 106-0101
240mm
(9.1/2") | 106-0102
260mm
(10.1/4") |
|--------------------------------------|--------------------------------------|--------------------------------------|----------------------------------|----------------------------------|--------------------------------------|---------------------------------------|

ROCHSTER PEAN
Curved on flat

HÆMOSTATS FORCEPS



- 106-0117**
150mm
(6")
- 106-0118**
180mm
(7")
- 106-0119**
200mm
(8")
- 106-0120**
230mm
(9")
- 106-0121**
255mm
(10")

O'SHAUGHNESSY
Curved, light weight



TUBING CLAMP
Heavy pattern, wedge jaw
106-0122 150mm(6")
106-0123 180mm(7")
106-0124 200mm(8")



- 106-0125**
- 106-0126**

FICKLING ORAL
106-0127
180mm(7") Angled to side ½ teeth
106-0128
180mm (7") Angled to side

TONSILS ARTERY FORCEPS



106-0129



106-0130



SCHNIDT TONSILS
106-0131 180mm(7")
Slight curved on flat



NEGUS TONSILS
106-0132 180mm(7")
small curved
106-0133 180mm(7")
Large Curved



WILSON TONSIL
106-0134 190mm(7.1/2")
Curved on flat
Angled shafts

MICRO NEEDLE HOLDERS



CASTROVIEJO
107-0001
145mm(5.3/4")
With catch



CASTROVIEJO
107-0002
145mm(5.3/4")
with catch



ARRUGA
107-0003
135mm(5.1/4")



BARRAQUER
107-0004
120mm(4.3/4")
with catch



BARRAQUER
107-0005
120mm(4.3/4")
without catch



CONVERSE
107-0006



DERF
107-0007



MAYO(DUNHILL)
107-0008



MAYO
107-0009

NEEDLE HOLDER



MAYO 107-0010 190mm
(7.1/2")



**CRILEWOOD
107-0011** 150mm
(6")



CRILE MURRAY 107-0012
145mm(5.3/4")



**KLINER
107-0013** 135mm
(5.1/4")



NAUTAN MORGAN



107-0014
190mm (7.1/2")
107-0015
250mm (10")



WANGENSTEEN



107-0016
270mm (10.3/4")

NEEDLE HOLDER



JAMESON
107-0016
230mm (9")



WRIGHT 107-0017
125mm (5")



GILLIES Combined
needle holder and
scissors **107-0018**
160mm (6.1/4")



WARD Combined
needle holder and
Scissors **107-0019**
180mm (7")



HEANY 107-0020
200mm (8")

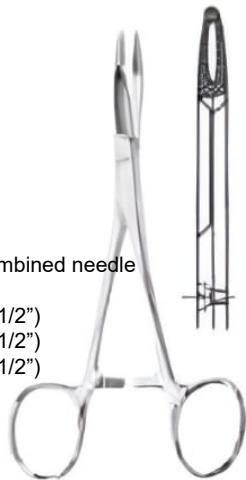

OLSAN HEGAR Combined needle
holder and scissors
107-0021 140mm(5.1/2")
107-0022 165mm(6.1/2")
107-0023 190mm(7.1/2")

NEEDLE HOLDERS



MAYO



MAYO (BAUMGARTNER)
107-0024 140mm(5.1/2")



MAYO(MASSON)
107-0025 265mm(10.1/2")



MAYO
107-0026 165mm(6.1/2")



107-0027
190mm (7.1/2")



107-0028
200mm (8")



107-0029
230mm(9")



HEGAR
107-0030
200mm(8")



HALESY 107-0031 125mm(5")



MATHIEU 107-0032 140mm (5.1/2")

NEEDLE HOLDERS



MATHIEU 107-0033
170mm (6.3/4")



MATHIEU 107-0034
200mm(8")



WEBSTER Smooth jaw 107-0035
115mm(4.1/2")



MAYO 107-0036
150mm(6")



MCPHAILS 107-0037
180mm(7")



LAWRANCE 107-0038
150mm(6") Lightweight
107-0039 150mm(6")

PROBES



BRODIE
107-0040
 200mm(8")
 Ball point



DIRECTORS
107-0041 130mm(5.1/8")
107-0042 145mm(5.3/4")
107-0043 160mm(6.1/4")



107-0044
 140mm(5.1/2")



SINUS
107-0045
 150mm(6")



PROBE
 with eye

- PROBE**
- 107-0046**
127mm(5")
- 107-0047**
152mm(6")
- 107-0048**
178mm(7")
- 107-0049**
200mm(8")
- 107-0050**
255mm(10")
- 107-0051**
305mm(12")



MYRTLE LEAF PROBE
107-0052
 145mm(5.3/4")



1mm Tip
107-0053
 145mm(5.3/4")

- 1.5mm tip**
- 107-0054**
130mm(5.1/8")
- 107-0055**
145mm(5.3/4")
- 107-0056**
160mm(6.1/4")
- 107-0057**
180mm(7")
- 107-0058**
200mm(8")
- 107-0059**
250mm(10")

- 2mm tip**
- 107-0060**
145mm(5.3/4")
- 107-0061**
160mm(6.1/4")
- 107-0062**
180mm(7")
- 107-0063**
200mm(8")

PROBES



LIEBRICH LACHRYMAL
107-0064 No.00_0(0.7-0.8mm)
107-0065 No.1-2(0.9-1.1mm)
107-0066 no.3-4(1.3-1.4mm)
107-067 no.5-6(1.5-1.6mm)



ANEL LACHRYMAL
107-0068
108mm(4.1/4")
0.6mm,small



JOBSON HORNE
107-0069 140mm(5.1/2")
107-0070 178mm (7")



FISTULA PROBE
107-0071 240mm(9.1/2")



KINGS COLLEGE HOSPITAL COCAINISING WIRE
107-0072 89mm (3.1/2")
107-0073 133mm (5.1/4")



LOGAN TUNER
107-0074 120mm
(4.3/4") 1.00mm
diameter



CAWTHRONE
107-0075 140mm
(5.1/2")

DISSECTORS



MZCDONALD 107-0076
185mm(7.1/4") Double end



WATSON CHEYNE
Fine with probe 107-0077 125mm(5")
107-0078 190mm (7.1/2")



KOCHER THYROID 107-0079 150mm (6")
107-0080 170mm (6.3/4")



KOCHER THYROID
107-0083 190mm(7.1/2")



KING
107-0084 195mm(7.3/4")



KING
107-0085 200mm (8")

DISSECTORS, SUTURE INSTRUMENTS



PAYR 107-0086
225mm (9")



PAYR 107-0087
280mm(11")



GWYNNE EVANS TONSILS 200mm(8")
Double ended **107-0088** 6mm wide
107-0089 8mm wide



LITTAUER 107-0090
110mm(4.1/2") with hook
End



LITTAUER(SPENCER)
107-0091 80mm (3.1/2")
with hook end

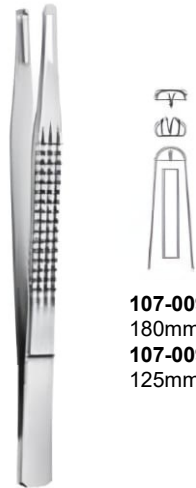

**CHARNLEY SUTURE
FORCEPS**



107-0092
180mm(7")
107-0093
125mm (5")

HAND HELD RETRACTORS



DEAVER 108-0001
15mm(8.1/2")
Blade: 22mm wide

DEAVER 108-0002
300mm(12")
Blade:25mm wide

DEAVER 108-0003
315mm(12.1/2")
Blade:25mm wide

DEAVER 108-0004
300mm (12")
Blade:38mm wide

DEAVER 108-0005
300mm(12.1/4")
Blade: 50mm wide

HAND HELD RETRACTORS



**DEAVER GRIP
NO.1 108-0006**
310mm(12.1/4")
Blade:25mm wide

**DEAVER GRIP
NO.2 108-0007**
310mm(12.1/4")
Blade:38mm wide

**DEAVER GRIP
NO.3 108-0008**
302mm(12")
Blade:50mm wide

**DEAVER GRIP
NO.4 108-0009**
310mm(12.1/4")
Blade:75mm wide

HAND HELD RETRACTORS



RICHARDSON
240mm(9.1/2")



108-0010 Blade:
23mm/20mm



108-0011 Blade:
30mm/29mm



108-0012 Blade:
37mm/37mm

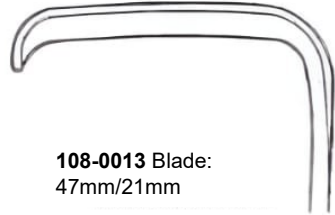

108-0013 Blade:
47mm/21mm

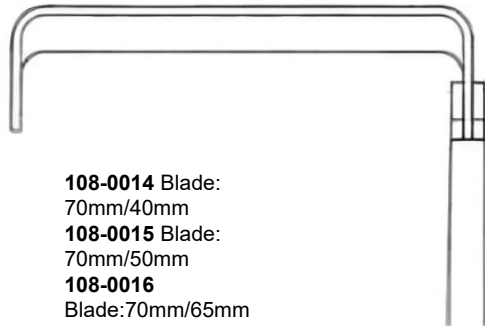

108-0014 Blade:
70mm/40mm
108-0015 Blade:
70mm/50mm
108-0016
Blade:70mm/65mm



MORRIS 245mm
(9.3/4") Single
blade

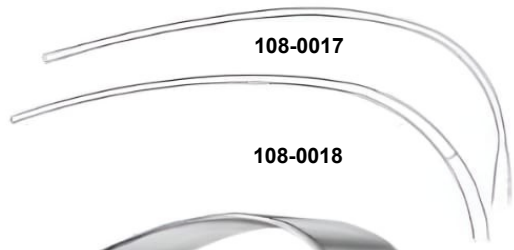

108-0017

108-0018



KELLY 108-0019
260mm (10.1/4")
Blade: 150mm/39mm

108-0020 260mm
(10.1/4") Blade:
150m/57mm

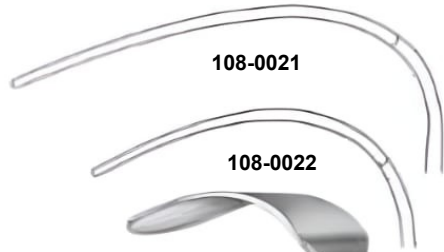

108-0021

108-0022



LIVER RETRACTORS
250mm (10") **108-0022**
Blade: 91mm/35mm
108-0021 Blade:
121mm/50mm

HAND HELD RETRACTORS

HAND HELD RETRACTORS



108-0023 220mm
(8.3/4") blade:
15mm/15mm

108-0024 215mm
(8.1/2")Blade:
20mm/22mm

108-0025
B235mm (9.1/4")
Blade:
28mm/28mm

DURHAM 215mm
(8.1/2") **108-0026**
Blade:10mm **108-0027**
Blade:16mm

MIDDELDORPF



108-0031



108-0032

KOCHER 108-0028
230mm(9")
Blade:36mm/20mm

MOYNIHAN 205mm(8")
108-0029 Blade: 20mm/15mm
108-0030 Blade: 20mm/12mm

HAND HELD RETRACTORS



108-0033 Blade:
25mm/6mm

108-0034 Blade:
35mm/8mm

108-0035 Blade:
35mm/11mm

108-0036 Blade:
35mm/15mm

108-0037 Blade:
41mm/11mm

108-0038 Blade:
55mm/11mm

108-0039 Blade:
70mm/14mm

108-0038
Blade:55mm/11mm

LANGENBECK
215mm(8.1/2")



KOCHER
108-0041 250mm(10")
Blade:67mm/25mm



CUSHINGS VEIN RETRACTORS
250mm (10")



108-0042 Blade;
14mm/11mm



108-0043 Blade: 18mm/13mm



108-0044 Blade: 22mm/15mm

HAND HELD RETRACTORS



SIMON 108-0056
220mm (8.3/4")



Doyen 108-0057
250mm (10") Blade:
53mm/80mm

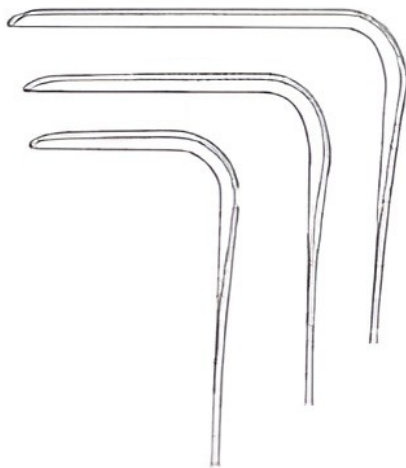

DOYEN 240MM (9.1/2")
108-0058 Blade: 60mm/45mm
108-0059 Blade: 90mm/45mm
108-0060 Blade: 120mm/45mm



HAND HELD RETRACTORS



**LANGENBECK
BONE HOOK
108-0061**
205mm(8")
Sharp



**LANGENBECK
BONE HOOK
108-0062**
205mm(8") Blunt



**KOCHER BONE
HOOK 108-0063**
220mm(8.3/4")
Sharp



**KOCHER BONE HOOK
108-0064** 220mm (8.3/4")
Blunt



108-0065
2 prong, sharp



108-0066
2 prong, blunt



108-0067
3prong, sharp



108-0068
3prong, blunt



108-0069
4prong, sharp



108-0070
4prong, blunt



108-0071
125mm(5")



108-0072
135mm(5.1/4")



108-0073
130mm(5.1/8")



KLINER
150mm (6")

108-0074
Sharp

108-0075
Blunt

RETRACTOR
155mm (6")
Flexible shaft

RETRACTORS

HAND HELD RETRACTORS



RICARD 108-0076

Lateral blades: 58mm/80mm
Centre blade: 54mm/70mm

108-0077

Lateral blades: 72mm/84mm
Centre blade: 72mm/90mm

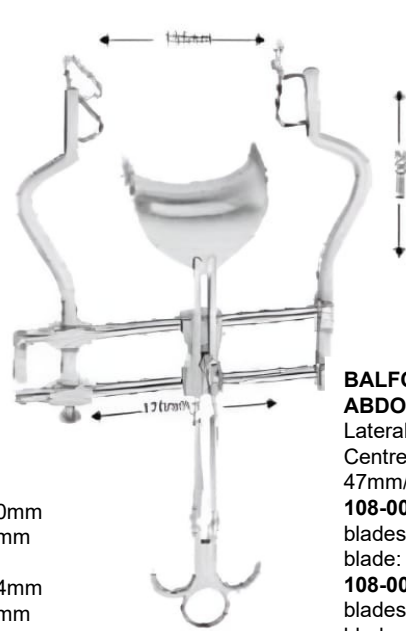

**BALFOUR
ABDOMINAL 108-0078**

Lateral blades: 60mm
Centre blade:
47mm/80mm

108-0079 lateral
blades:60mm Centre
blade: 62mm/76mm

108-0080 Lateral
blades:90mm Centre
blade: 80mm/80mm

108-0081 Lateral
blades: 105mm Centre
blade: 59mm/107mm

KIRSCHNER RETRACTOR SET 108-0082

Set comprising of:
1/ 108-0083
2/108-0084
2/108-0085

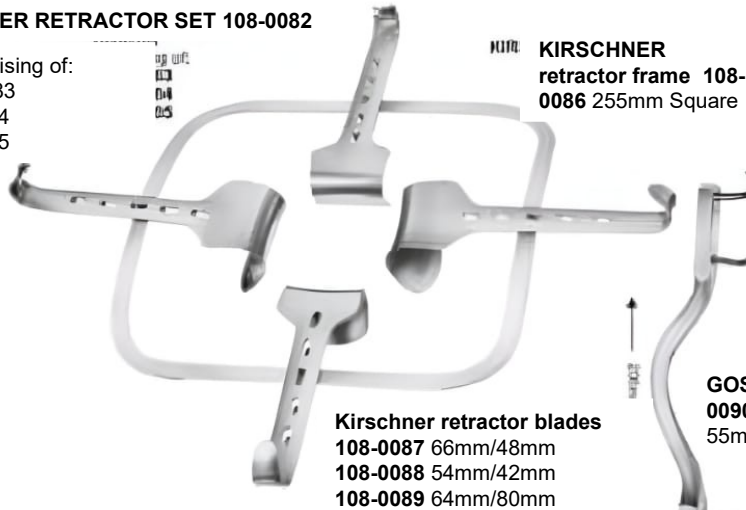

**KIRSCHNER
retractor frame 108-
0086 255mm Square**

Kirschner retractor blades

108-0087 66mm/48mm
108-0088 54mm/42mm
108-0089 64mm/80mm

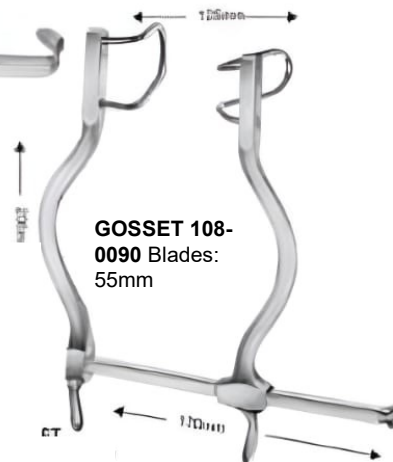

**GOSSET 108-
0090** Blades:
55mm

HAND HELD RETRACTORS



GOLIGHER 108-0091

Complete with two center
Blades: 51mm deep, and four
Lateral blades
2/51mm deep
2/102mm deep



Berkeley abdominal 108-0092

Blades:
35mm/60mm



TRAVERS 108-0093

200mm(8")
4/5 teeth
blunt



IRWIN 108-0094

178mm(7")
4/5 teeth
Sharp

HAND HELD RETRACTORS



WEISLANDER 108-0095
110mm (4.3/8") 2/3 teeth
Sharp



WEISLANDER 108-0096 110mm
(4.3/8") 2/3 teeth blunt



RNTNE HOSPITAL 108-0097 159mm (6.1/4") 3/4 teeth



NORFOLK AND NORWICH 108-0098 215mm (8.1/2") 4/5 teeth, blunt



WEISLANDER
3/4 teeth, blunt
108-0099 130mm(5.1/8")
108-0100 156mm(6.1/2")



WEISLANDER
3/4 teeth, Sharp
108-0101 130mm(5.1/8")
108-0102 165mm(6.1/2")



WEISLANDER
3/4 teeth, semi sharp
108-0103 130mm (5.1/8")
108-0104 165mm(6.1/2")

HAND HELD RETRACTORS



WEISLANDER

108-0105
195mm(7.3/4")
3/4 teeth Sharp



108-0108
195mm (7.3/4")
3/4 teeth Blunt



108-0106
240mm(9.1/2")
3/4 teeth Sharp



108-0109
240mm(9.1/2")
3/4 blunt



108-0107
255mm(10")
5/6 teeth Sharp



108-0110
255mm(10")
5/6 blunt



CONE 108-0111
145mm (5.3/4")



JANSON (SHEA) 108-0112
105mm (4.1/8")



JEFFERSON
140mm(5.1/2")

CHOLECYSTECTOMY & GALLSTONE



GEARY GRANT
109-0001 230mm
(9") Large curved



LAHEY
109-0002
195mm(7.3/4)
109-0003
230mm (9")



LOWER
109-0004
180mm
(7")



MIXTER
109-0005
220mm (8.3/4")
109-0006
250mm (10")

INTESTINAL CLAMPS



DOYEN
165mm
(6.1/2")
Spring
blades

109-0011
Straight

1090012
Curved



109-0015
Straight

109-0016
Curved

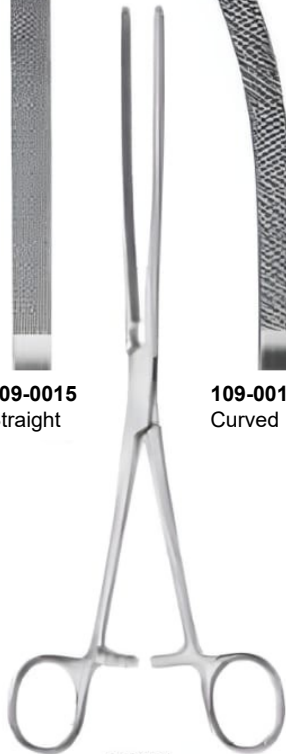

DOYEN
235mm
(9.3/4) spring
blades



109-0013
Straight

109-0014
Curved



DOYEN
170mm
(6.3/4")



DOYEN
235mm(9.3/4")
Spring blades

INTESTINAL CLAMPS



DOYEN(KOCHER)
Straight, light spring blade
109-0019 230mm(9")

109-0021
290mm (11")
109-0022
290mm (11.4")



DOYEN(MAYO ROBSON)
curved, light spring blade
109-0023 230mm(9")

109-0025
290mm (11")
109-0026
290mm (11.4")



KOCHER
Spring blade
109-0027
290mm (11")
109-0028
290mm (11")

INTESTINAL CLAMPS



LANE 109-0029
210mm(8.1/4")



**SETON PRINGLE
(BAINBRIDGE)**
109-0030 150mm (6")
Straight **109-0031**
150mm (6") Curved



DOYEN (MAYO ROBSON)
Spring blades **109-0032**
255mm(10") **109-0033**
280mm (11")

INTESTINAL CLAMPS



SCHOEMAKER
Hollow blades for hemisphincterectomy
109-0034 170mm (6.3/4")
1009-0035 215mm (8.1/2")

PARKER KERR
Anastomosis forceps for colon
resection
109-0036 250mm (10")

LANG STEVENSON
109-0037
200mm (8")

PAYR 109-0038
200mm (8") JAW: 65mm
109-0039 280mm (11")
JAW: 100mm
109-0040 350mm (14")
JAW: 150mm

INTESTINAL CLAMPS



LAWN TWIN ANASTOMOSIS
109-0041 300mm (12")
Curved



LAWN TWIN ANASTOMOSIS
109-0042 300mm (12")
Straight



CUSO 110-0001
75mm/17mm Extra
small for virgins



GRAVE 110-0004
75mm/20mm
110-0005 95mm/30mm
110-0006 195mm/33mm



McGEE Lateral VIGINAL RETRACTOR
With ratch handle **110-0003**



CUSO 110-0002
75mm/17mm Extra
small virgins



PBDQRBON
110-0010 103mm a 22mm
110-0011 120mm a 25mm



CUSO
110-0007 110mm a 27mm
110-0008 80mm a 22mm
110-0009 80mm a 24mm

VAGINAL SPECULUM

SIMS 111-0001
 125mm (5") Small
 70mm/26mm
 75mm/30mm
111-0002 150mm(6")
 Medium
 75mm/30mm
 80mm/35mm
111-0003 175mm(7")
 Large 80mm/36mm
 90mm/40mm

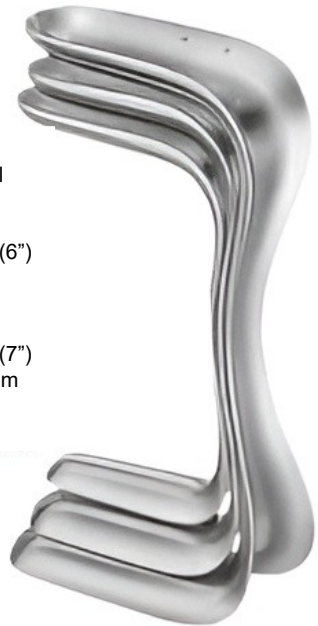

**LOWER
 BLADE**

**UPPER
 BLADE**

111-0004
 175mm(7")
 Blade:
 70mm/15mm



111-0008
 175mm (7")
 Blade:
 70mm/10mm



111-0005
 180mm(7")
 Blade:
 70mm/27mm



111-0009
 180mm(7")
 Blade:
 75mm/23mm



111-0006
 180mm(7")
 Blade:
 75mm/30mm



111-0010
 180mm (7")
 Blade:
 80mm/25mm



111-0011
 185mm
 (7.1/4") Blade:
 100mm/32mm



111-0007
 185mm
 (7.1/4") Blade:
 90mm/36mm



KRISTELLE

KRISTELLE

VAGINAL SPECULUM

MATHIEU 111-0012
210mm (8.1/4")
Blade: 95mm/17-
30mm
For children and
virgins



DOYEN 240mm (9.1/2")
111-0013 Blade:
60mm/35mm

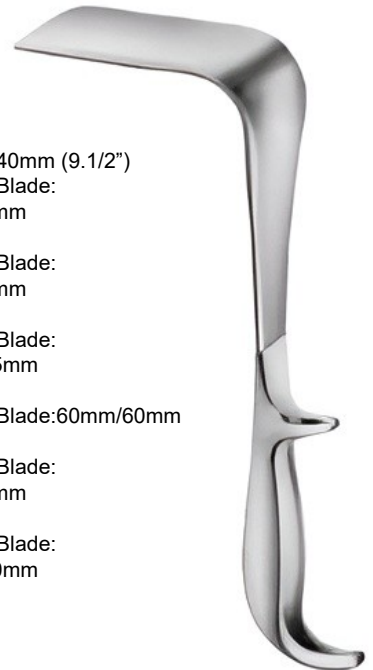

111-0014 Blade:
90mm/35mm

111-0015 Blade:
120mm/35mm

111-0016 Blade:60mm/60mm

111-0017 Blade:
90mm/60mm

111-0018 Blade:
120mm/60mm

MODIFIED WERTHEIM
320mm (1.23/4")

111-0019 Blade:
100mm/25mm

111-0020 Blade:
100mm/30mm

111-0021 Blade:
100mm/35mm

111-0022 Blade:
100mm/40mm

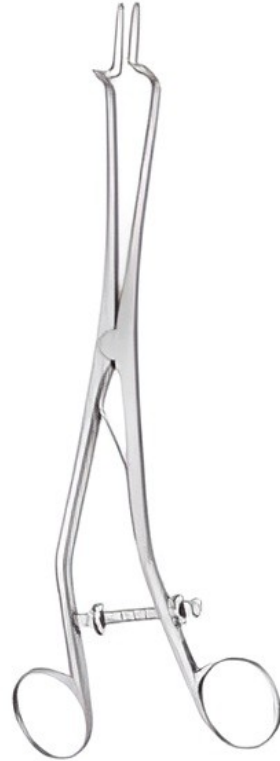

KOGAN ENDOCERVICAL SPECULUM

111-0023

240mm (9.1/2")

Graduated

VAGINAL SPECULUM

VAGINAL RETRACTOR/ UTERINE DILATORS



AUVARD 111-0024
230mm (9") Blade:
63mm/38-28mm
Weight: 1.53kg (3lb, 60z)
Fixed weight

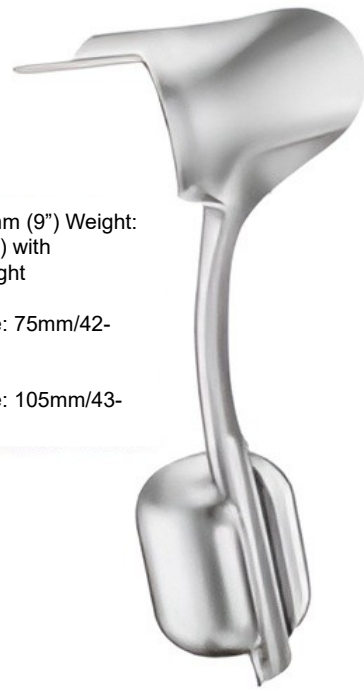

AUVARD 230mm (9") Weight:
1.47kg (3lb,4oz) with
detachable weight

111-0025 Blade: 75mm/42-
40mm

111-0026 Blade: 105mm/43-
40mm



O6-09443
Set of twelve

- 111-0027 6mm
- 111-0028 7mm
- 111-0029 8mm
- 111-0030 9mm
- 111-0031 10mm
- 111-0032 11mm
- 111-0033 12mm
- 111-0034 13mm
- 111-0035 14mm
- 111-0036 15mm
- 111-037 16mm
- 111-038 17mm

HAWKIN AMBLER
170mm(6.3/4")
Cervix dilator



HOGAR
105mm (7.1/4")
Cervix dilator

111-0039
Set of sixteen
Consisting of one of
Each of: 111-0040 to 111-0056

111-0040	2mm	111-0052	12mm	111-0063	8.5mm
111-0041	3mm	111-0053	14mm	111-0064	9.5mm
111-0042	4mm	111-0054	15mm	111-0065	10.5mm
111-0043	5mm	111-0055	16mm	111-0066	11.5mm
111-0044	6mm	111-0056	17mm	111-0067	12.5mm
111-0045	7mm	111-0057	2.5mm	111-0068	13.5mm
111-0046	8mm	111-0058	3.5mm	111-0069	14.5mm
111-0047	9mm	111-0059	4.5mm	111-0070	15.5mm
111-0048	10mm	111-0060	5.5mm	111-0071	16.5mm
111-0049	11mm	111-0061	6.5mm	111-0072	17.5mm
111-0050	12mm	111-0062	7.5mm		

UTERINE DILATORS/ PROBES



HEGAR 205mm
(8") Cervix dilator
double ended

111-0073 Set of eight
consisting of one of
each of : 111-0074 to
111-0082

- 111-0074** 1mm-2mm
- 111-0075** 3mm-4mm
- 111-0076** 5mm-6mm
- 111-0077** 7mm-8mm
- 111-0078** 9mm-10mm
- 111-0079** 11mm-12mm
- 111-0080** 13mm-14mm
- 111-0081** 15mm-16mm
- 111-0082** 17mm-18mm



GALABIN 111-0083
290mm (11.1/2")
Shaft graduated
15 cm's Malleable



SIMS 111-0084
330mm (13")
111-0085
330mm (13")
Malleable



MARTIN 111-0086
330mm (12")

UTERINE DILATORS COMPLETE SETS



111-0087 HEGAR Dilator set consisting of: 14 dilators, 1 Rack for dilators (4-12mm) 1 Rack for dilators (13-17mm) 1 Metal case only, with hinged lid, stainless 200/100/35 mm



...
111-0088 HEGAR Dilator set consisting of: 26 dilators, 1 Rack for dilators (1-17mm) 1 Rack for dilators (18-26mm) 1 Metal case only, with hinged lid, Aluminium 330/220/80 mm

TENACULUM FORCEPS



BROWN
112-0001
250mm (10")
Standard



SCHROEDER
112-0002
230mm (9")



WILBON
112-0003
240mm (9.1/2")

OVUM FORCEPS



HEYWOOD SMITH
112-0004
240mm (9.1/2")



MCLINTOCK
112-0005
240mm(9.1/2")



NOTO
112-0006
280mm (11")

OVUM FORCEPS



DOYEN
112-0007
105mm (7.1/4")



112-0008
250mm (10")



BONNEY POLYPI
112-0009
240mm (9.1/2")

CERVICAL BIOPSY FORCEPS

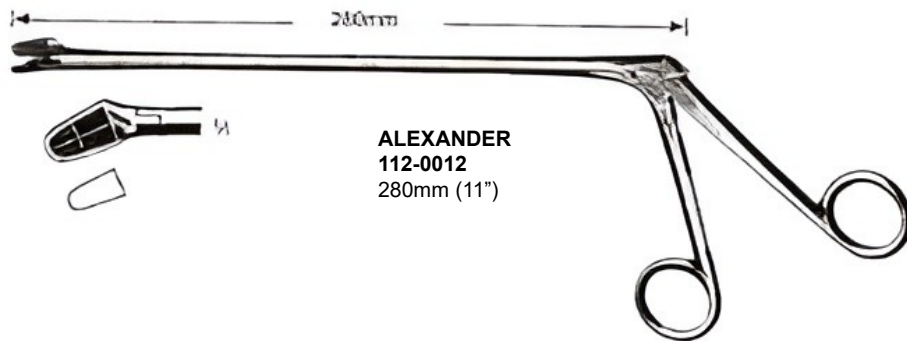
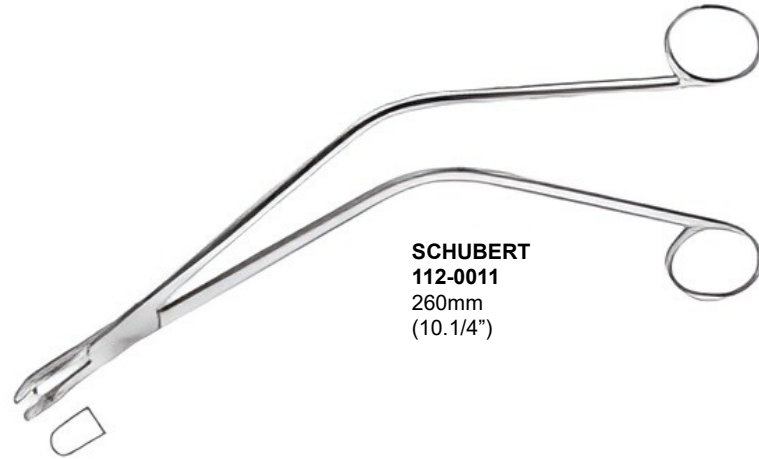
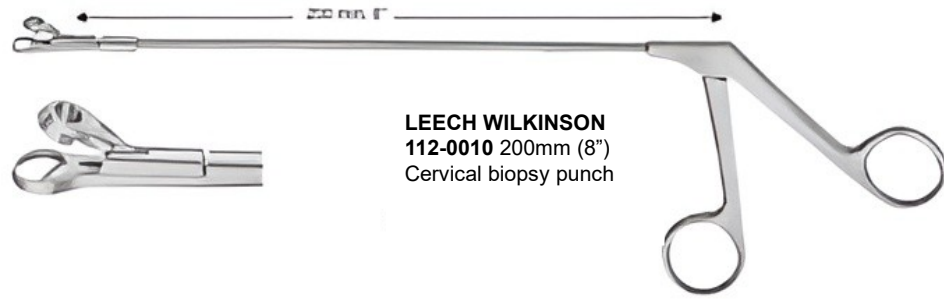

CERVICAL BIOPSY FORCEPS

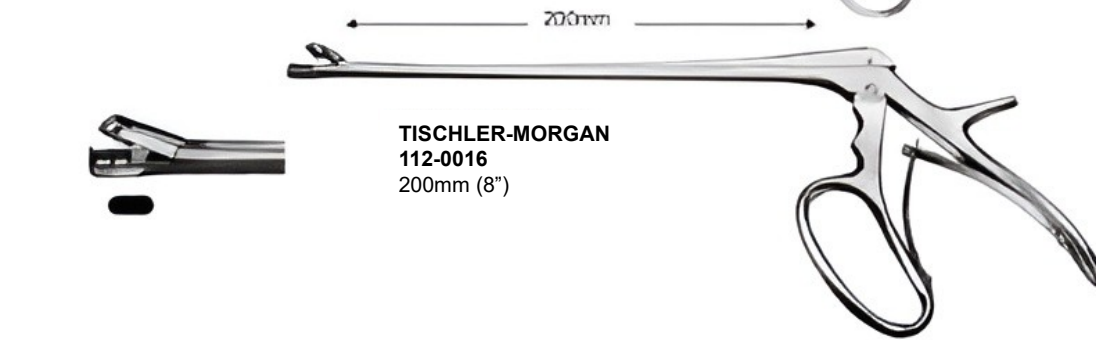
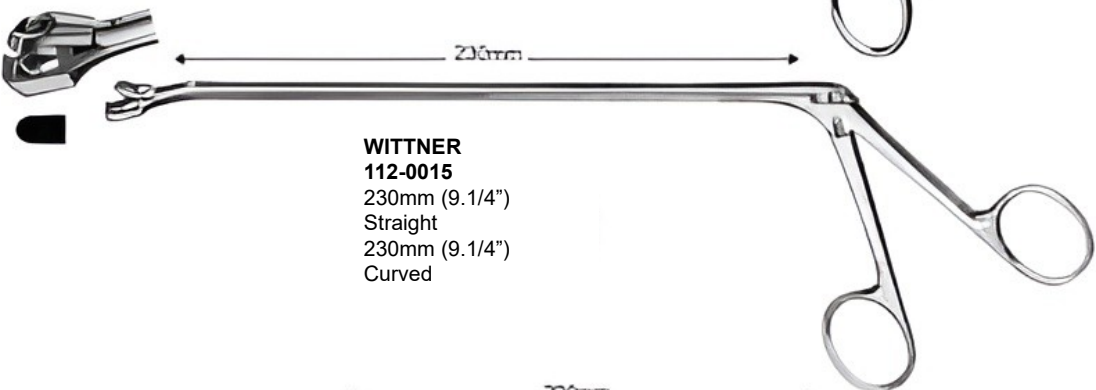
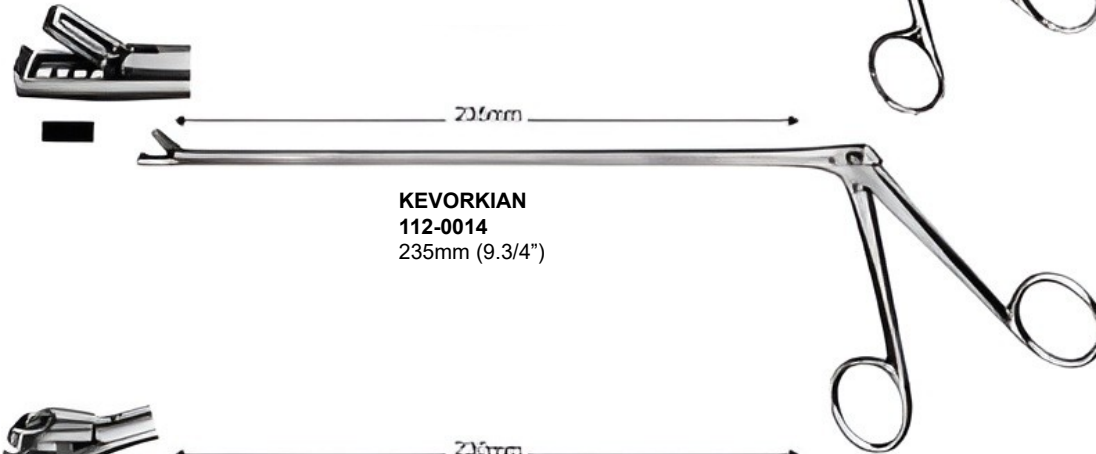
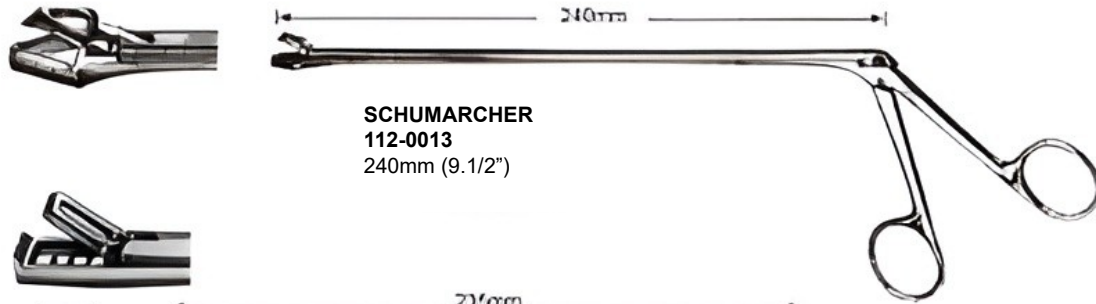

UTERINE SCOOPS & CURETTES

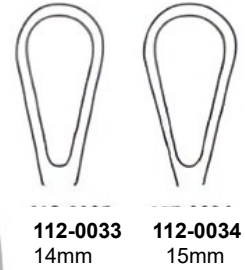
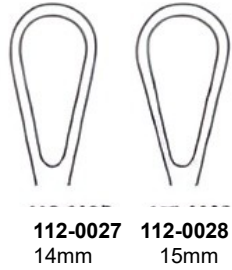
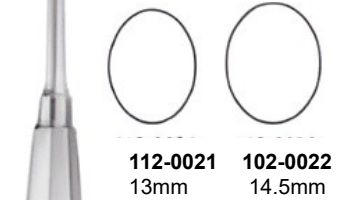
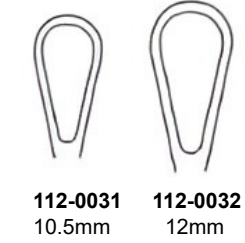
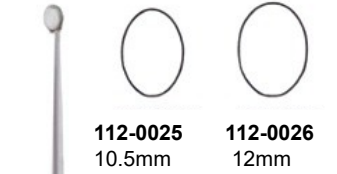
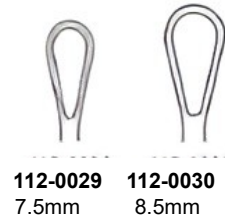

SIMON
240mm (9.1/2")

SIMS
255mm (10")
Rigid, sharp

SIMS
255mm (10")
Malleable, sharp

UTERINE CANNULAE



SIMS
112-0053
280mm (11")



RECAMIER
112-0054
310mm (13")



BUMM
112-0055
280mm (11")

OBSTETRICS INSTRUMENTS



SIMPSON
112-0056 300mm
(12")



SIMPSON-BRAUN
112-0057 330mm
(13")



DeLEE
112-0058 300mm
(12")



DeLEE
112-0059 360mm (14.1/2")



ELLIOT
112-0060 320mm (12.1/2")



NAEGELE 112-0061
360mm (14.1/2")



I.U.D.REMOVING HOOK 112-0062
320mm (12.1/2")



WRIGLEY 112-0063
250mm (10")



KIELLAND 112-0064
402mm (16.3/4")

OBSTETRICS INSTRUMENTS



LUIKART
112-0065
400mm (16")



KELLAND-LUIKART
112-0066 400mm (16")



SIMPSON-LUIKART
112-0067 360mm (14.1/2")



McLEAN-TURKER-LUIKART
112-0068 400mm (16")



McLEAN-TUCKER
112-0069
390mm 915. 1/2")



McLEAN-LUIKART
112-0070
390mm (15.1/2")



McLEAN
112-0071
360mm (14.1/2")



BARTON
112-0072
360mm (14.1/2")



BARTON
112-0073
170mm (6.3/4")

DERMATOLOGY, GYNECOLOGY INSTRUMENTS



**GREEN-ARMYTAGE
HEAMOSTASIS FORCEPS 113-
0001 200mm (8") Straight
113-0002 195mm (7.3/4") Angled**



113-0003 113-0004 113-0005



**WINTER OVUM FORCEPS
200mm (11.1/2")**



**SAENGER OVUM FORCEPS
113-0006 275MM (10.3/4")**



**UMBILICAL DILATOR
113-0007 95mm (3.3/4")**



13-0008

113-0009

MIKULICZ 113-0008 180mm (7")
113-0009 205mm (8")



113-0010

113-0011

PEROTONEUM 113-0010 205mm(8")
113-0011 205mm (8")



113-0012

113-0013

FAURE 112-0012 205mm(8")
113-0013 205mm (8")

PERITONEUM, HYSTERECTOMY CLAMPS

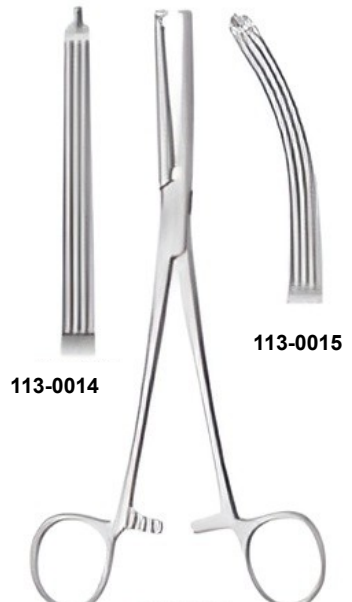

113-0014

113-0015

GWILLIAM HYSTERECTOMY 200mm(8")
113-0014 Straight
113-0015 Curved



113-0016

HEANY HYSTERECTOMY FORCEPS
200mm(8") **113-0016** Curved, Single
tooth



113-0017

113-0018

HEANY
113-0017 205mm(8")
113-0018 245cm (9.3/4")

HYSTERECTOMY CLAMPS



**MAINGOT GYSTERECTOMY
FORCEPS 113-0019** 200mm(8")
Curved, 1/2 teeth **113-0020**
Straight, 1/2 teeth **113-0021**
240mm(9.1/2") Curved, 1/2 teeth

PHANEUF 113-0022
205mm(8") Straight, 1/2
teeth

BONNEY 113-00203 205mm(8")
Angled on flat, 1/2 teeth



113-0024



113-0025



113-0026
220mm
(8.3/4")



113-0027
240mm
(9.1/2")



113-0028
225mm
(9")



113-0029



113-0030



113-0031

**HYSTERECTOMY
FORCEPS**
Atraumatic

PROCTOLOGY



KELLY PROCTOSCOPE
113-0032 140mm(5.1/2")
Diameter, 22mm

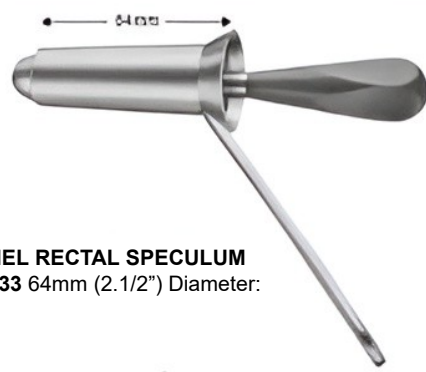

GABRIEL RECTAL SPECULUM
113-0033 64mm (2.1/2") Diameter:
25mm



MCEVEDY RECTAL SPECULUM WITH BATTERY HANDLE
113-0034 150mm(6")
Diameter: 27mm

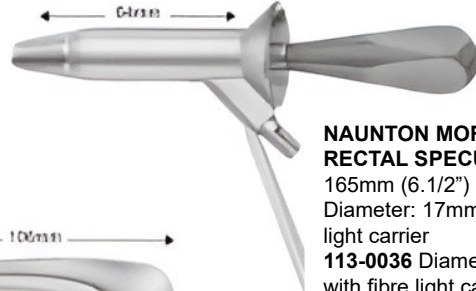

NAUNTON MORGAN RECTAL SPECULUM
165mm (6.1/2") 113-0035
Diameter: 17mm with fibre
light carrier
113-0036 Diameter:21mm
with fibre light carrier
113-0037 Diameter: 24mm
with fibre light carrier



PRATT RECTAL SPECULUM 113-0038 205mm (8")



CZERNY RECTAL SPECULUM 113-0039 225mm(9")



SIMS RECTAL SPECULUM 113-0040 160mm (6.1/4")

UROLOGY



113-0041
A
230mm(9")

113-0042
B
200mm(8")

113-0043
C
195mm(7.3/4)

113-0044
D
180mm (7")



RANDALL
Renal calculus
forceps



MILLIN
113-0045
245mm(9.3/4")
Ligature holding
forceps



BLADDERSPATULA
113-0046 235mm(9.3/4")
Blade:91mm/61mm



GUYON 113-0047
265mm (10.1/2")

KIDNEY CLAMP
113-0048 255mm(10")

UROLOGY



HERRICK 113-0049
225mm (9")

113-0050	6/10	(2.3/33mm)
113-0051	8/12	(2.66/4.66")
113-0052	10/14	(3.33/4.66)
113-0053	12/16	(4/5.33mm)
113-0054	14/18	(4.66/6mm)
113-0055	16/20	(5.33/6.66)
113-0056	18/22	(6/7.33)
113-0057	20/24	(6.66/8)
113-0058	22/26	(7.33/8.66)
113-0059	24/28	(8/9.33)
113-0060	26/30	(8.66/33)
113-0061	28/32	(9.33/10.66)

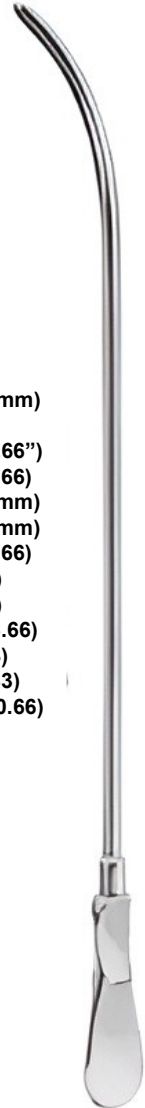

COTTON URETHRAL SOUNDS
265mm (10.1/2") Set Twelve
112-0062 Set comprising one
of each of:



FEMALE CATHETERS
160mm (6.1/4")

113-0062
12 (4mm)

113-0063
8 (3.33mm)

113-0064
10 (3.33mm)

113-0065
14 (4.66mm)

113-0066
16 (5.33mm)

SUCTION TUBES

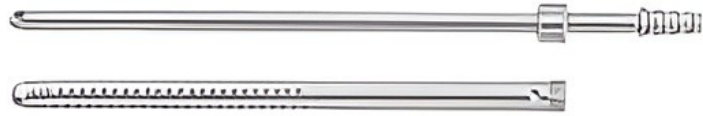

113-0069
240mm (9.1/2")

POLE

113-0070
180mm (7")
Lawrie extension piece



YANKAUER 113-0067
305mm (12")

113-0068
Rose end

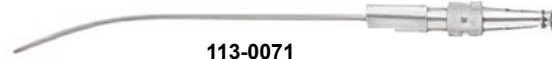

113-0071
GILLIES 170mm
(6.3/4") Control
value

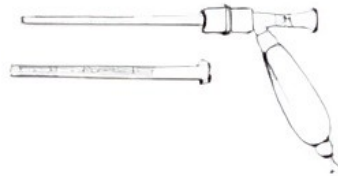

TINCKLER (SIMPSON SMITH) 113-0072 255mm
(10") With on/off value , removable perforated outer
sheath

UROLOGY



BARRON 113-0073
230mm (9")
Diameter: 1.33mm



FRAZIER 113-0074 185mm
(7.1/4") Diameter 2.33mm
113-0075 185mm (7.1/4")
Diameter 2.66mm
113-0076 185mm (7.1/4")
Diameter 3mm

BELUCCI 113-0077 Set comprising of each of the following items: **BELUCCI SUCTION TUBE 113-0078** 170mm (6.3/4") Diameter: 2mm **ZOELLNER DETACHABLE ENDS**

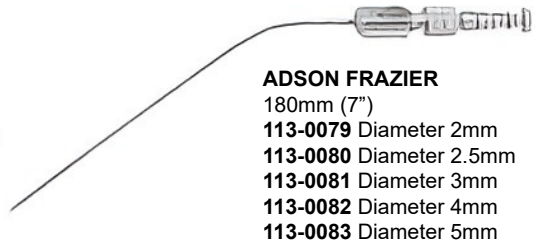

ADSON FRAZIER
180mm (7")
113-0079 Diameter 2mm
113-0080 Diameter 2.5mm
113-0081 Diameter 3mm
113-0082 Diameter 4mm
113-0083 Diameter 5mm

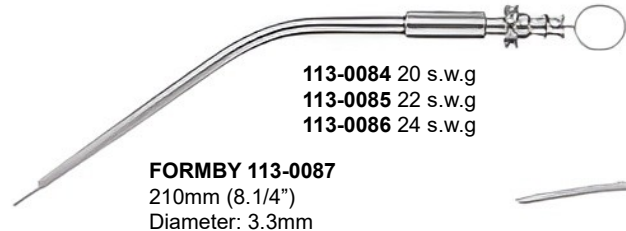

113-0084 20 s.w.g
113-0085 22 s.w.g
113-0086 24 s.w.g

FORMBY 113-0087
210mm (8.1/4")
Diameter: 3.3mm



ADSON 180mm (7")
113-00088 Diameter 3mm
113-0089 Diameter 5mm

HOUSE Shaft: 90mm (3.1/2")
Suction and irrigation tube

113-0090 Diameter Suction tube:
0.9mm Diameter irrigation tube:
0.7mm

113-0091 Diameter suction tube:
1.2mm Diameter irrigation tube:
0.9mm

113-0092 Diameter suction tube:
1.5mm Diameter irrigation tube:
1.2mm



CONE SUCTION TUBES
113-0093



SUCTION TUBES 113-0094
Diameter: 3mm
113-0095 Diameter: 4mm
113-0096 Diameter: 5mm

HANDLE 113-0097 100mm
(4") with tucker valve

AMPUTATION INSTRUMENTS



**PERCY AMPUTATION FLAP
RETRACTOR**

114-0001
Removable handles



AMPUTATION SAW
With hinged back
to take apart
114-0002
Blade: 230mm (9")

114-0003
Spare blade for
amputation saw



FINGER SAW
114-0004
200mm (8")



**ARMY REGULATION
AMPUTATION SAW**

114-0005
Blade: 182mm (7")
With hinged back
to take apart

UROLOGY BONE LEVERS & RASPATORIES



115-0001
140mm (5.1/2")
Width at tip 2.8mm



115-0002
160mm (6")
Width at tip 6mm

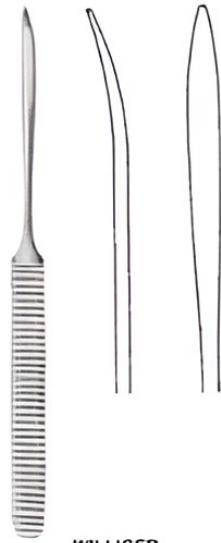

WILLIGER
115-0003
175mm (7")
Width at tip 5.5mm



WILLIGER
115-0004
160mm (6.1/4")
Width at tip 6.5mm

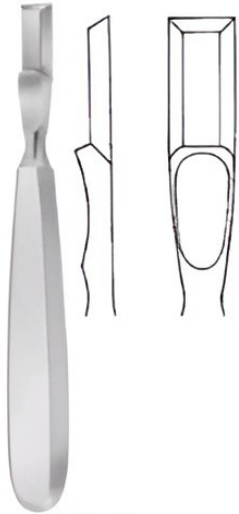

FARABEUF
100mm (4.1/4")
8mm wide
115-0005 Straight
115-0000 Curved



HOWARTH
115-0007 220mm (9")



JOSEPH
115-0007
170mm (6.3/4")
Width at tip 4mm



MACDONALD
115-0008
185mm (7.1/4") blunt



FRIGER ELEVATOR
115-0009
100mm (7.1/2"),
double ended

BONE LEVERS & RASPATORIES



ADSON
105mm (0.1/2"), curved
115-0010 width 5mm
115-0011 width 7mm



ADSON
105mm (0.1/2") straight curve
115-0012 Width 7mm



PENNYBACKER
100mm (0")
115-0013
Width 5mm



VOLKMANN
170mm (0.3/4")

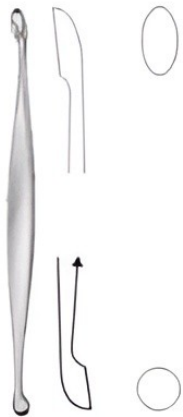
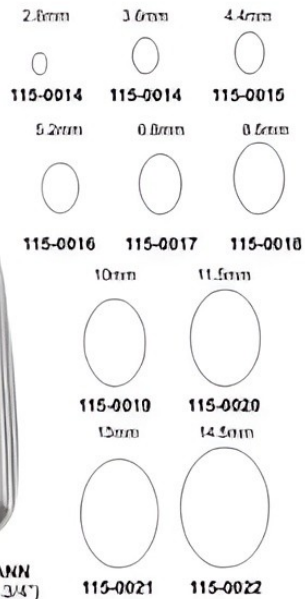

BOYD BONE CURETTE
Oval, double ended
115-0023 130mm (0.1/1")



BOYD BONE CURETTE
Oval, double ended
115-0024 100mm (0.1/4")



BOYD BONE CURETTE
Oval, double ended
115-0025 200mm (0")

BONE SCOOPS



VOLKMAN
Double ended
115-0026
130mm (5 1/8")
115-0027
140mm (5 1/2")
115-0028
170mm (6 3/4")



MACEWEN
180mm (7")
Combined
with scalpel
115-0029
Oval
115-0030
Round



JACOBSON
115-0031
140mm (5 1/2")



MARTINI
115-0032
140mm (5 1/2")



MARTINI
115-0033
140mm (5 1/2")



LEMPERT
200mm (8")

115-0014
2mm x 3.5mm

115-0015
2mm x 4mm

115-0016
2.5mm x 4.5mm

115-0017
2.75mm x 5mm

115-0018
3mm x 5mm

115-0019
3.25mm x 5mm



COLLIER AND MORRIS
180mm (7")

115-0040
2mm x 3mm

115-0041
3mm x 4mm

115-0042
4mm x 5mm

115-0043
5mm x 6mm



LUCAS
116-0001
Diameter: 27mm
8.1/2 oz



KELSEY FRY
116-0002 190mm (7.1/2")
Diameter: 20mm
SPARE DISKS
116-0003 Spare disks for
Kelsey-Fry Mallet



HEATH
116-0004
Diameter: 25mm 20 oz
116-0005
Diameter: 40mm 36 oz

MALLETS, BONE HOLDING FORCEPS



SEQUESTUM
FORCEPS
116-0006
190mm (7.1/2")
Straight



SEQUESTUM
FORCEPS
116-0007
190mm (7.1/2")
Angled



FERGUSON
116-0008
250mm (8")

BONE HOLDING FORCEPS

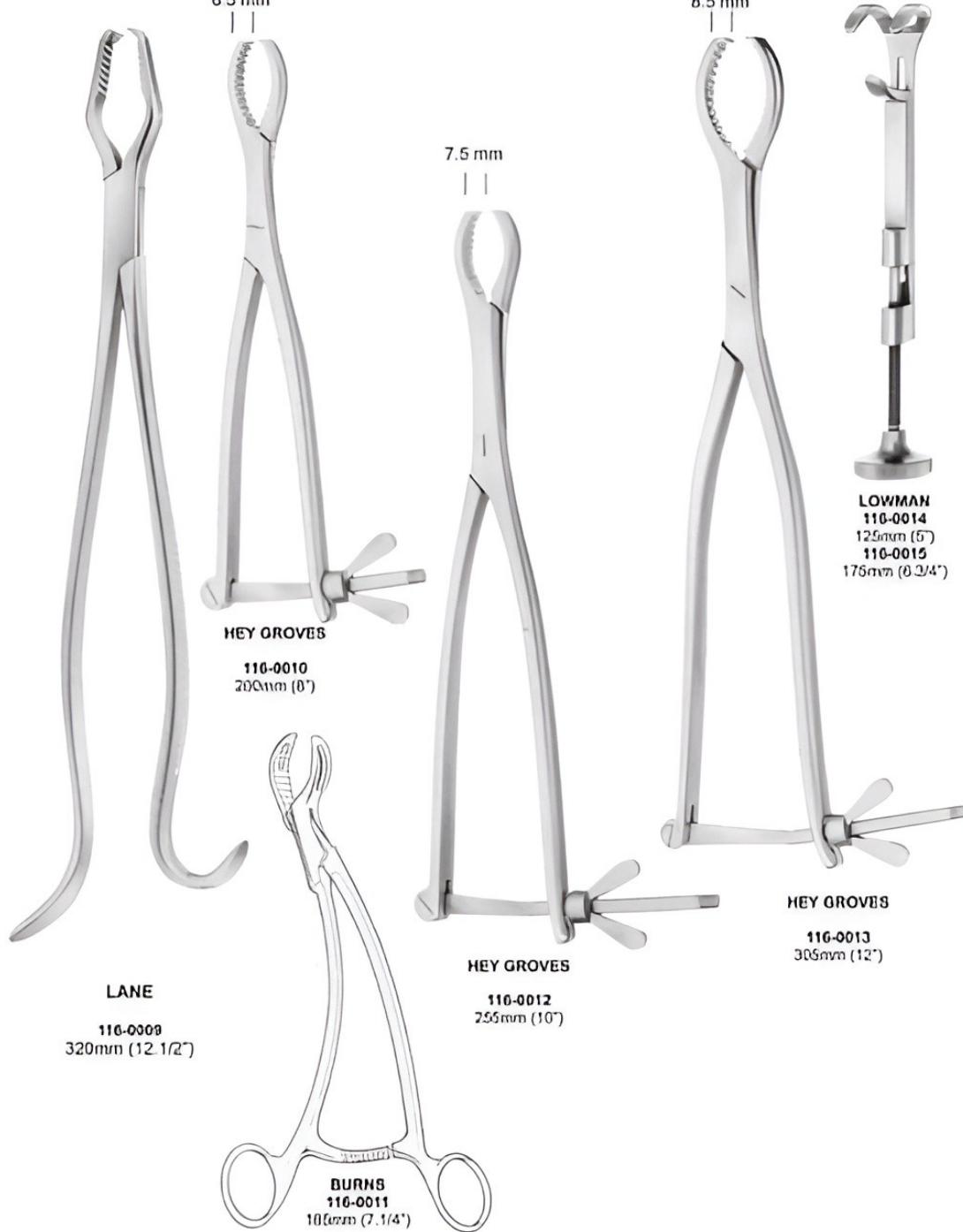



BEYER
117-0001
150mm (6")
5mm bite



**JANßEN-MIDDLETON
SEPTUM FORCEPS**
117-0002
200mm (8") Spoon shaped
4mm bite



CAIRNS
117-0003
140mm (5 1/2")
4mm bite



CAIRNS
117-0004
140mm (5 1/2")
4mm bite



LUER
117-0005
105mm (6")

BONE RONGEURS



RUSKIN
117-0006
180mm (7 1/2")
6mm bite

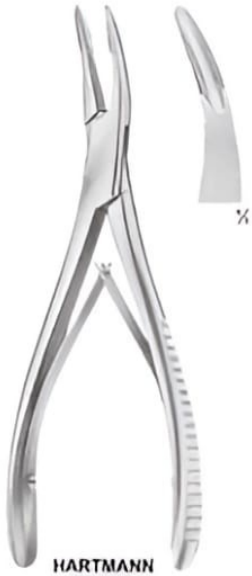

HARTMANN
117-0007
180mm (7")



MEAD
117-0008
165mm (6 1/2")



JANßEN
117-0009
150mm (6")

BONE RONGEURS



LUER-JANSEN
117-0010
170mm (6 3/4")
4mm bite



BEYER
117-0020
180mm (7")
4mm bite



BEYER
117-0021
200mm (8")
4mm bite



KILLEARN
117-0022
107mm (7 3/4")
3mm bite



ZAUFAL-JANSEN
117-0023
240mm (9 1/2")
4mm bite



ECHLIN
117-0024
240mm (9 1/2")
4mm bite



NORTHFIELD
117-0025
225mm (9") 10mm bite

BONE RONGEURS



TROTTER
117-0010
200mm (8")
10mm bite



**SYNOVECTOMY
RONGEUR**
117-0011
175mm (7")
4mm bite



HEANLEY
117-0012
175mm (7")
4mm bite



PENNYBACKER
117-0013
200mm (8")
4mm bite



**SYNOVECTOMY
RONGEUR**
117-0014
130mm (5 1/8")
Jaw width 2mm



NORTHFIELD
117-0015
200mm (8")
10mm bite



WILMS
117-0010
200mm (8")
4mm bite

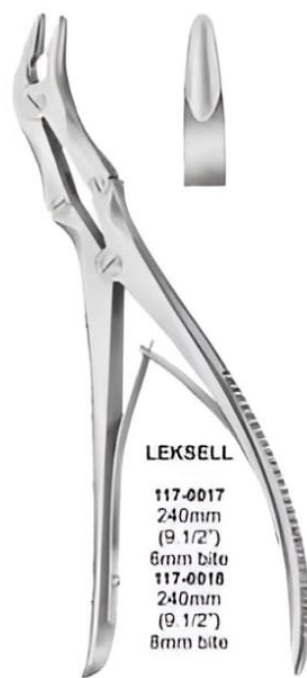

LEKSELL
117-0017
240mm
(9 1/2")
6mm bite
117-0018
240mm
(9 1/2")
8mm bite

BONE RONGEURS



SARGENT (VAN HAVRE)
117-0026
220mm (8.3/4")
10mm bite



OLIVECRONA
117-0027
230mm (9")
6mm bite



STILLE-RUSKIN
117-0028
240mm (9.1/2")

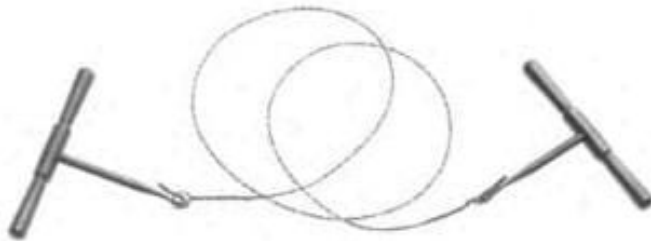

GIGLI SAW WITH HANDLE

117-0029
500mm (20")



RUDOR EDWARDS COSTOTOME

117-0030
230mm (9")

DISC RONGEURS

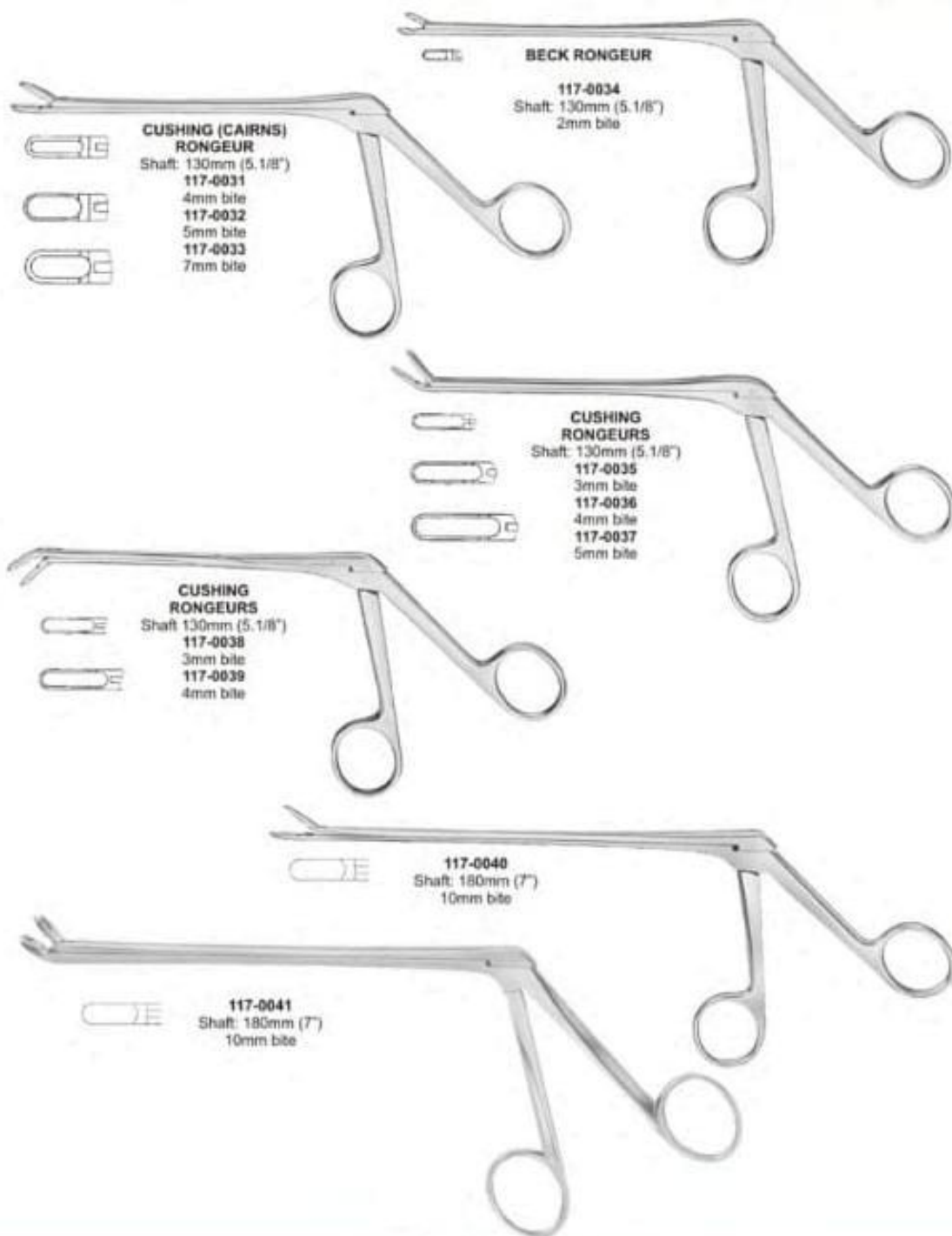

BONE CUTTING FORCEPS



RUBKIN - LISTON
117-0042 100mm (7.1/2")
Straight
117-0043 100mm (7.1/2")
Angled on flat



WARD
117-0044
170mm (6.3/4")



117-0045
145mm (5.3/4")



117-0046
150mm (6")



DE VILDBIG
117-0047
210mm (8.1/4")



**LISTON
(TUDOR EDWARDS)**
117-0048
205mm (10.1/2")

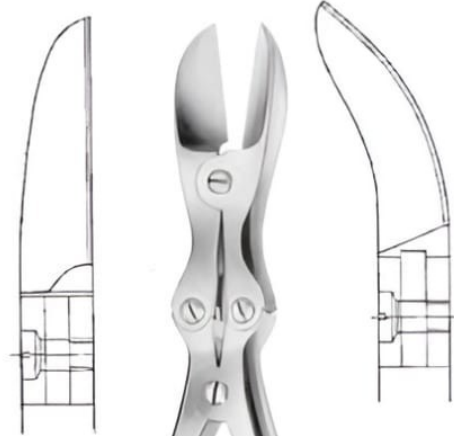

**STILLE
LISTON**
117-0049
210mm (11")
Straight
117-0050
270mm (10.3/4")
Curved on flat

PLASTER CAST REMOVAL INSTRUMENTS



PLASTER SHEARS

110-0001
100mm (0.1M')



PLASTER SHEARS

110-0002
200mm (0')

110-0003
210mm (0')



PLASTER SHEARS

110-0004
230mm (0.1/4')

RIB SPREADERS

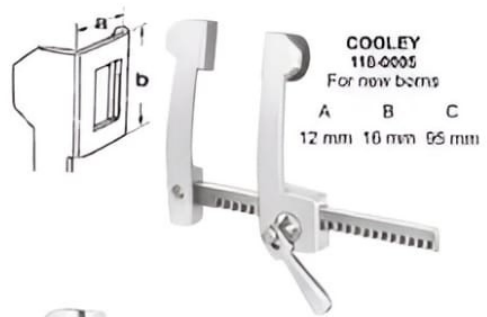

COOLEY
110-0005
For new borns
A B C
12 mm 10 mm 95 mm

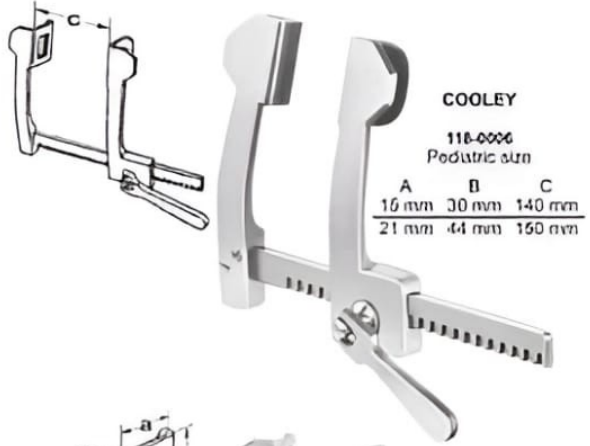

COOLEY
110-0006
Pediatric size
A B C
10 mm 30 mm 140 mm
21 mm 44 mm 160 mm



COOLEY
110-0007
For adults
A B C
35 mm 50 mm 200 mm



FINOCCHIETTO - INFANT
110-0003
For babies

a	b	c
15mm	15mm	70mm

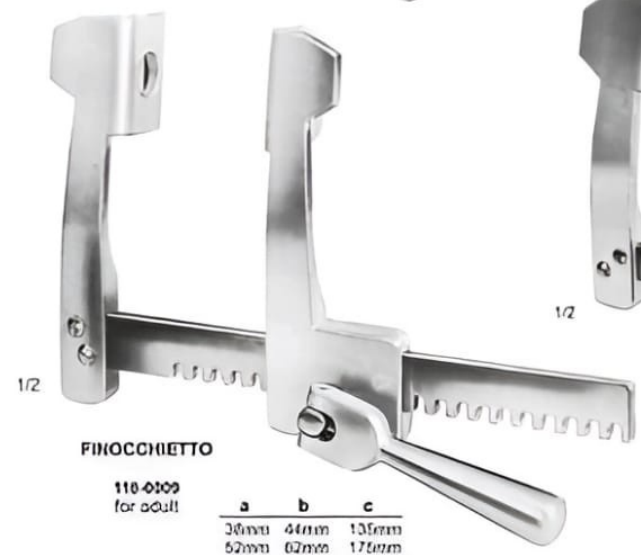

FINOCCHIETTO

110-0009
for adult

a	b	c
30mm	44mm	135mm
52mm	62mm	170mm
85mm	85mm	175mm

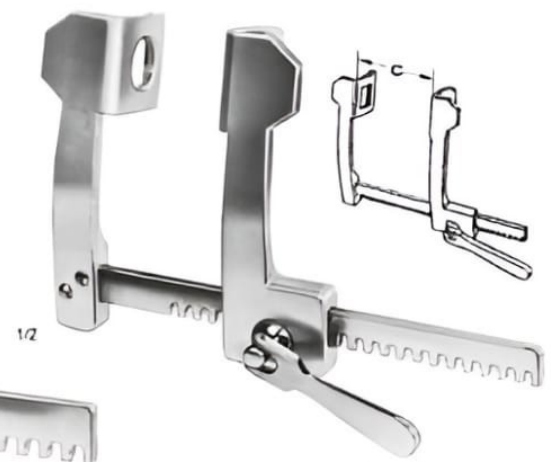

FINOCCHIETTO-BABY
110-0010
Child size

a	b	c
31mm	31mm	102mm

RIB SPREADERS



BURFORD
118-0011
For children
with 2 pairs of blades

a	b	c
48mm 36mm	42mm 42mm	13mm 13mm



BURFORD
118-0012
for adults
with pairs of blades

a	b	c
64mm 47mm	62mm 62mm	16mm
65mm 47mm	62mm 62mm	26mm
65mm 47mm	62mm 62mm	30mm

BRONCHUS, LIGATURE, TISSUE & ORGAN HOLDING FORCEPS



PRICE-THOMAS
119-0001 220mm (8 3/4")

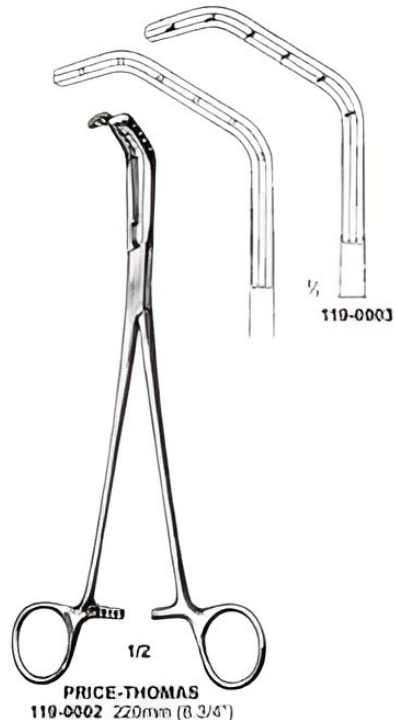

PRICE-THOMAS
119-0002 220mm (8 3/4")

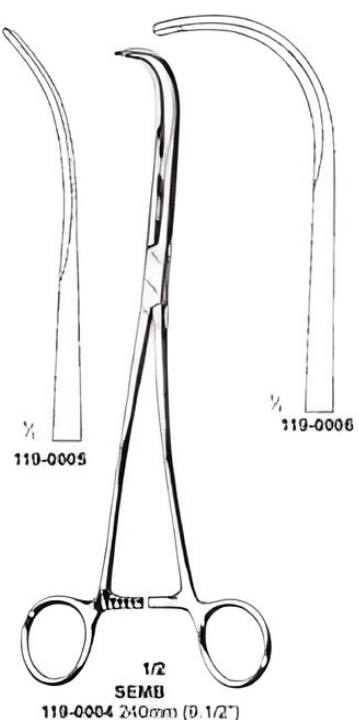

SEMB
119-0004 240mm (9 1/2")



LOVELACE
Straight
119-0007
200mm (8")

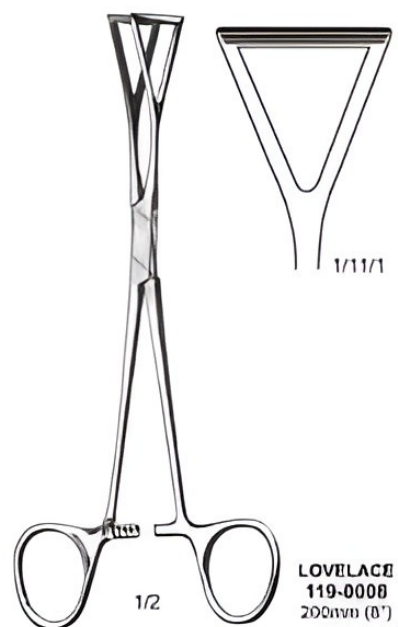

LOVELACE
119-0008
200mm (8")

ATRAUMA BULLDOG CLAMPS



1/1
DE-BAKEY SATINSKY
119-0009 70mm (2.3/4")



1/1
DE-BAKEY-CAROTIS
110-0010 92mm (3.1/2")



1/1
DE-BAKEY SATINSKY
110-0011 100mm (4")

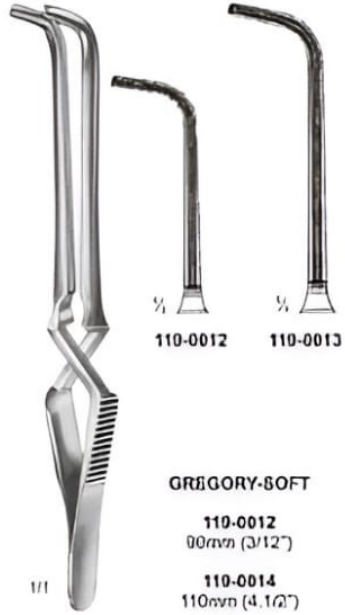

1/1
GREGORY-SOFT
110-0012
90mm (3.1/2")
110-0014
110mm (4.1/4")



1/1
DEBAKEY BULLDOG CLAMPS



1/1
119-0014
75mm (3")



1/1
119-0015
85mm (3.1/2")



1/1
119-0016
105mm (4.1/4")



1/1
119-0017
120mm (4.3/4")



1/1
DEBAKEY BULLDOG CLAMPS



1/1
119-0018
70mm (2.3/4")



1/1
119-0019
80mm (3.1/4")



1/1
119-0020
100mm (4")



1/1
119-0021
115mm (4.3/4")

ATRAUMA HEMOSTATIC, CARDIOVASCULAR FORCEPS



DE BAKAY-RANKIN
120-0001
Straight 160mm (6.1/4")
120-0002
Curved 160mm (6.1/4")

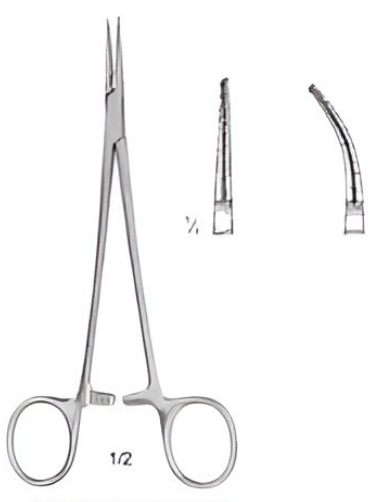

DE BAKAY-MOSQUITO
120-0003
Straight 160mm (6")
Curved 160mm (6")



OCHSNER
120-0004
235mm (9.1/4")



DIETRICH
120-0005
210mm (8.1/4")

ATRAUMA CARDIOVASCULAR FORCEPS

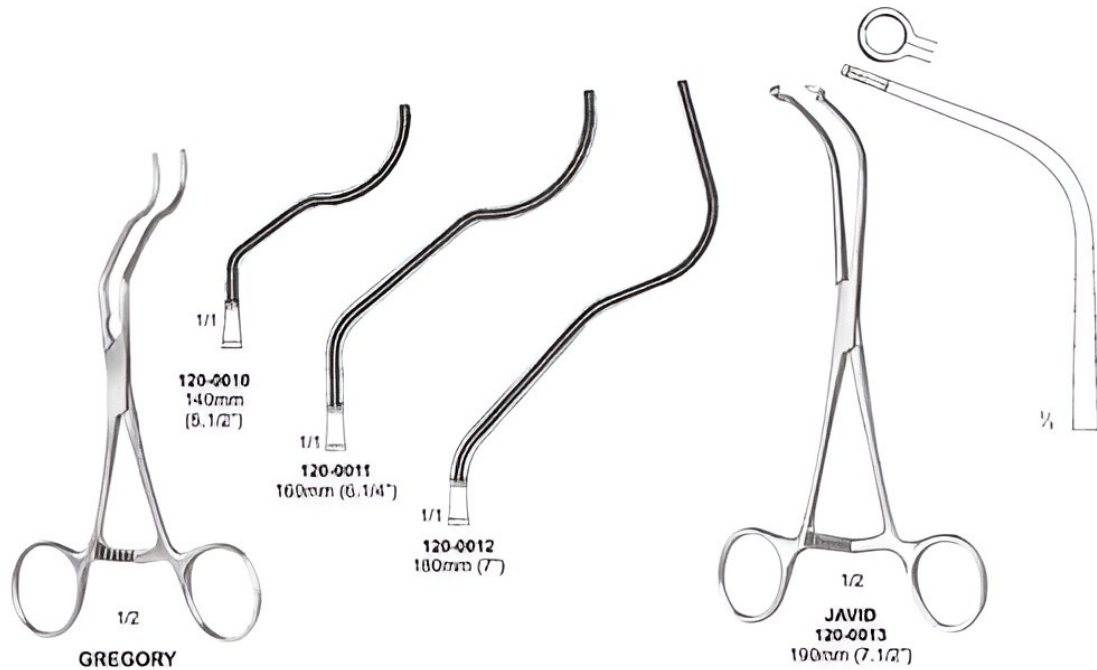
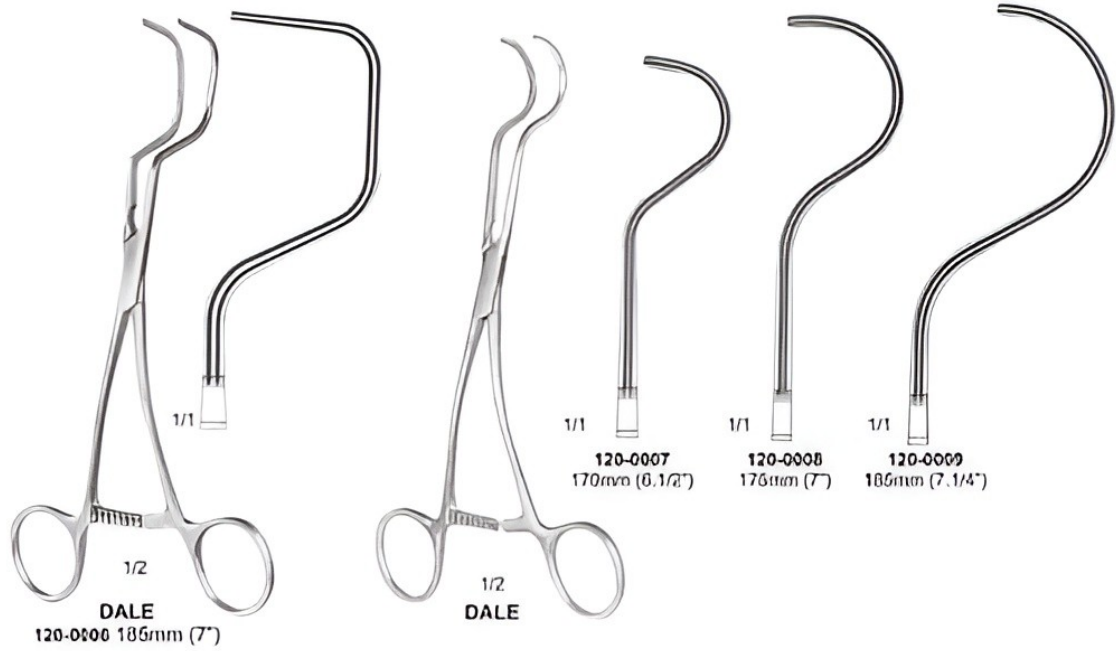

AUTRAUMA CARDIOVASCULAR FORCEPS

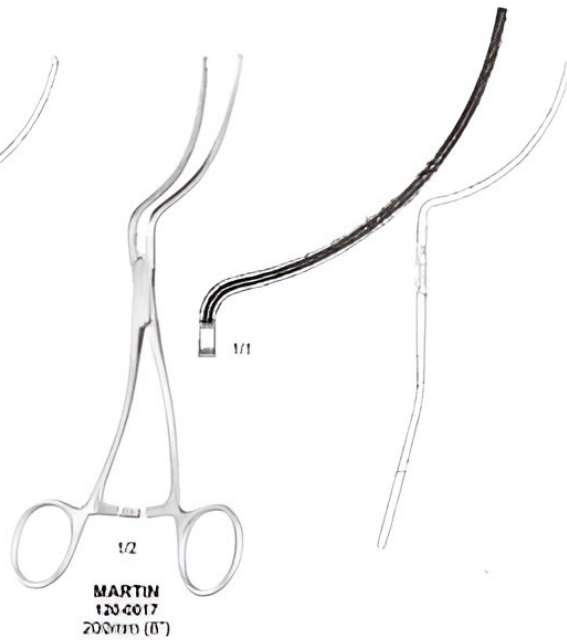
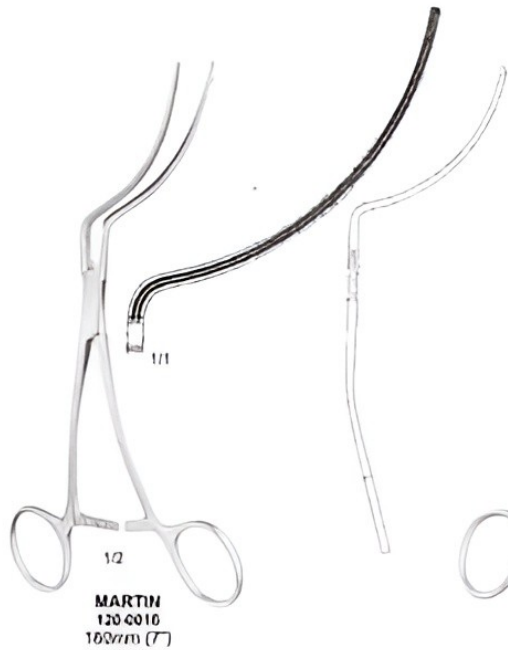
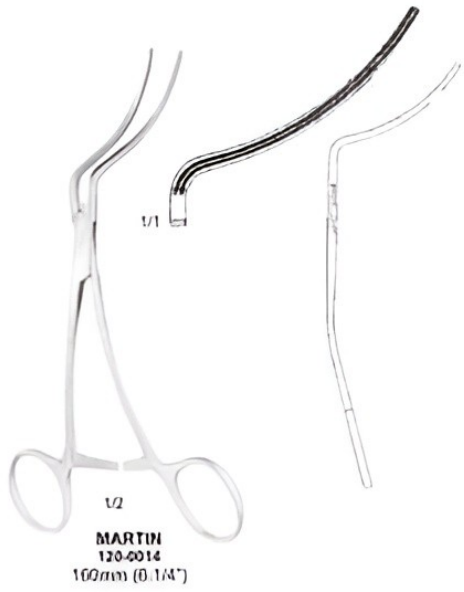

VASCULAR MEASURING DEVICE, FORCEPS

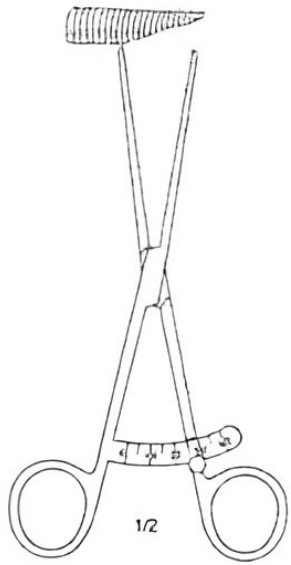

MEASURING FORCEPS

120-0018
Straight - 180mm (7")

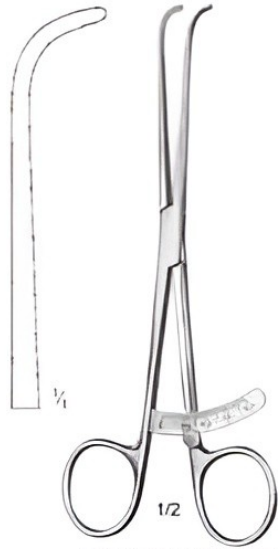

MEASURING FORCEPS

120-0010
Straight - 180mm (7")

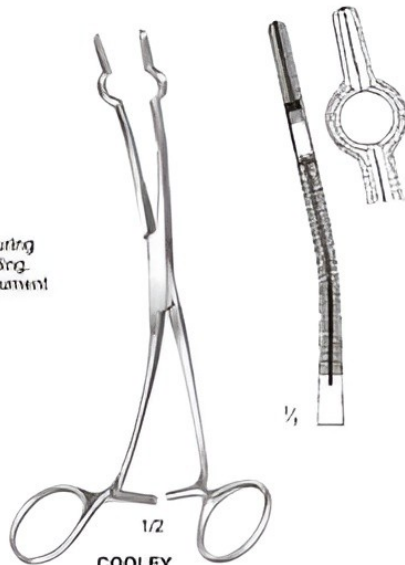
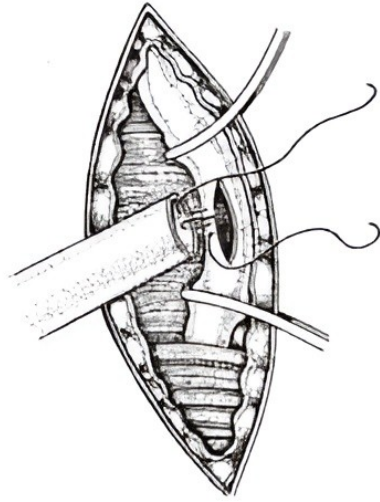

1/2
COOLEY
120-0020
old
120-0021
new

Cooley type caval occlusion used during cardiopulmonary By-Pass for occluding the vena cava. The tips of the instrument point down indicating carotid.

AUTRAUMA TISSUE FORCEPS



DE BAKLEY

- 120-0022 100mm (0.1/4")
- 120-0023 200mm (0")
- 120-0024 240mm (0.1/4")
- 120-0025 300mm (12")



DE BAKLEY

- 120-0026 160mm (0.1/4")
- 120-0027 200mm (0")
- 120-0028 240mm (0.1/4")

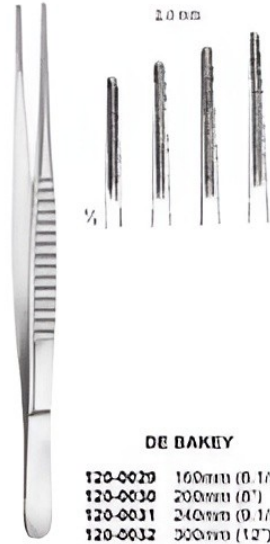

DE BAKLEY

- 120-0029 160mm (0.1/4")
- 120-0030 200mm (0")
- 120-0031 240mm (0.1/4")
- 120-0032 300mm (12")

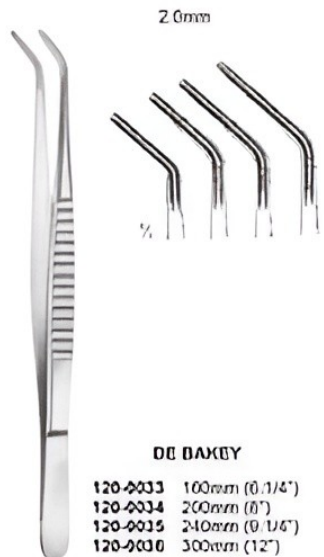

DE BAKLEY

- 120-0033 100mm (0.1/4")
- 120-0034 200mm (0")
- 120-0035 240mm (0.1/4")
- 120-0036 300mm (12")

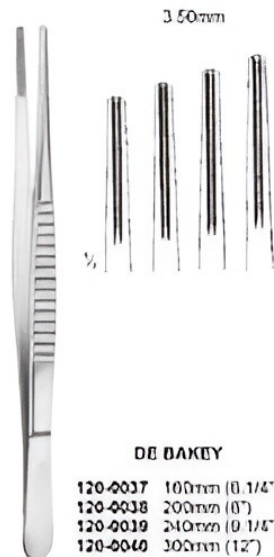

DE BAKLEY

- 120-0037 160mm (0.1/4")
- 120-0038 200mm (0")
- 120-0039 240mm (0.1/4")
- 120-0040 300mm (12")



COOLEY

- 120-0041 160mm (0.1/4")
- 120-0042 200mm (0")

AUTRAUMA CARDIOVASCULAR FORCEPS

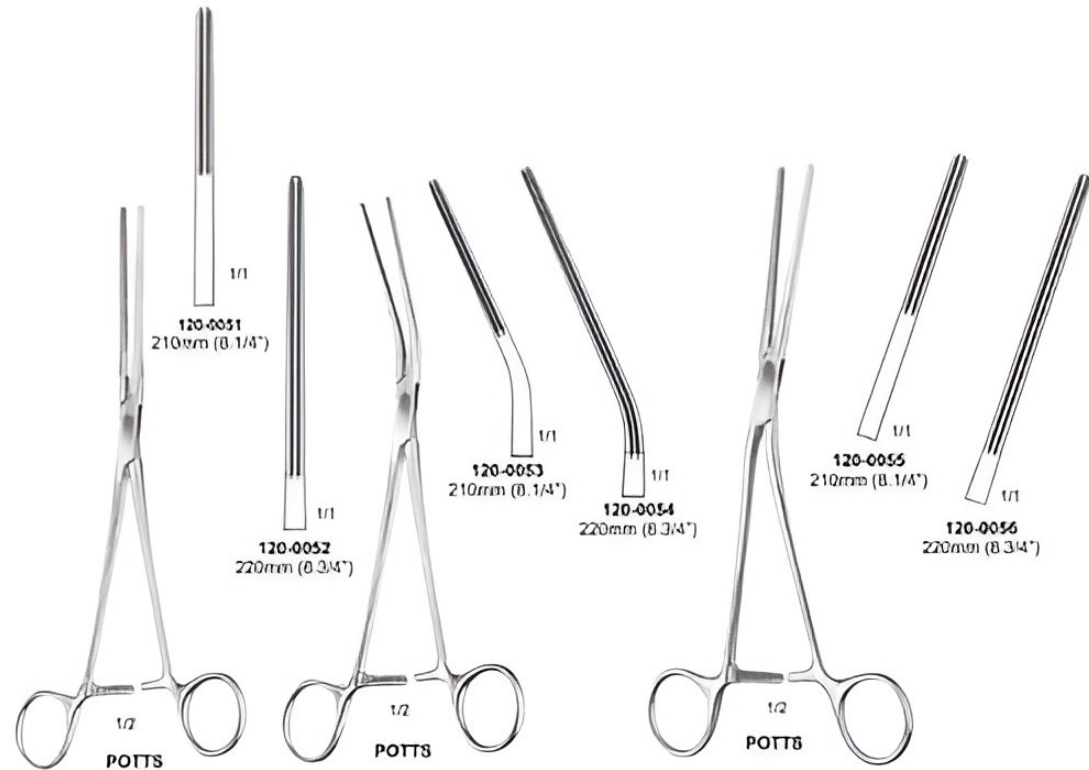
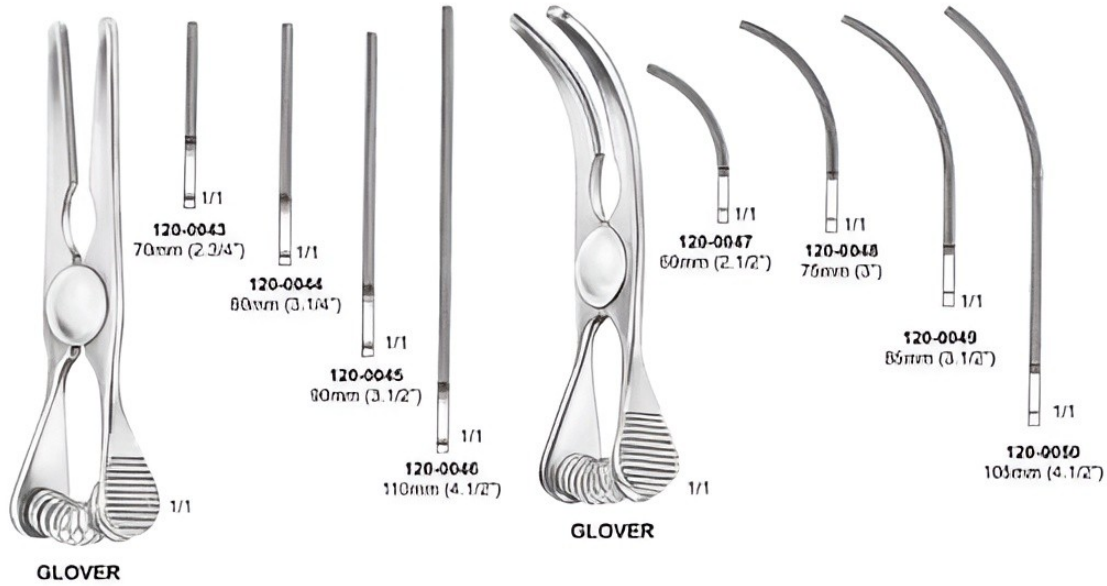

AUTRAUMA CARDIOVASCULAR FORCEPS

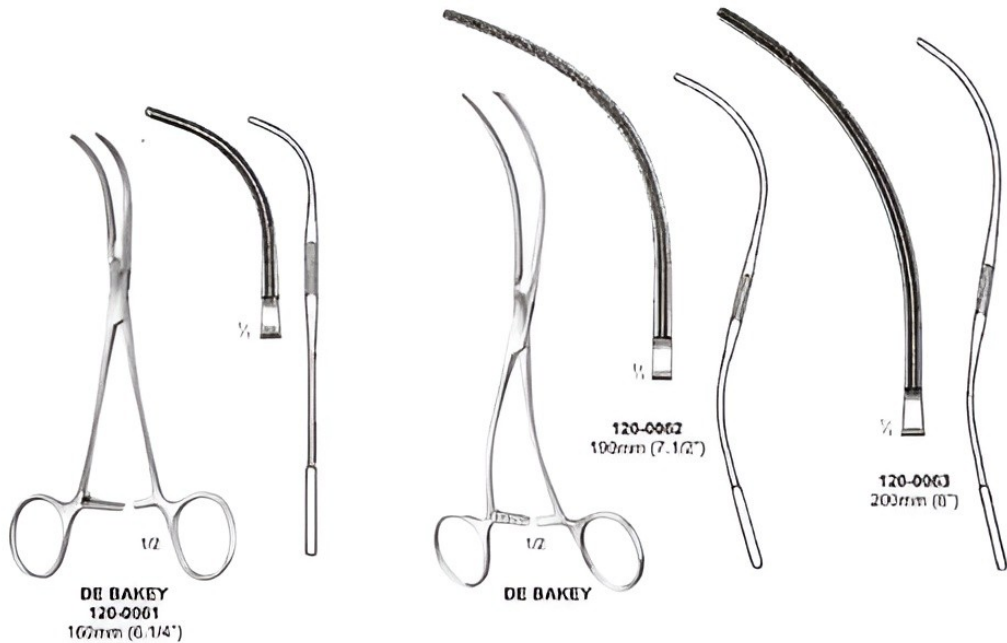
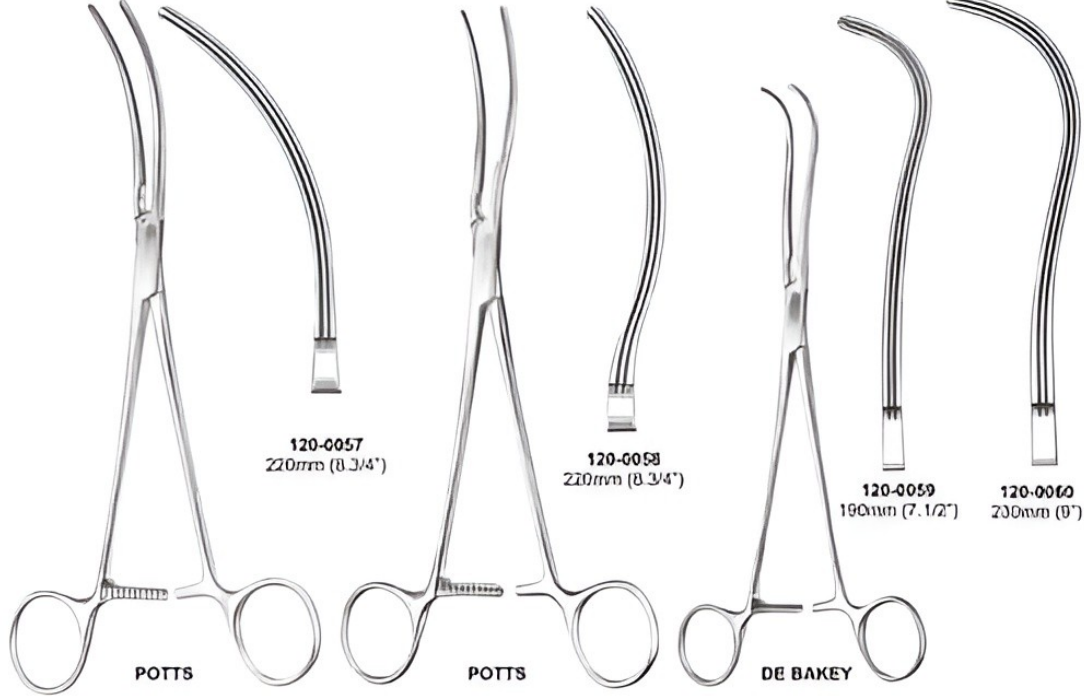

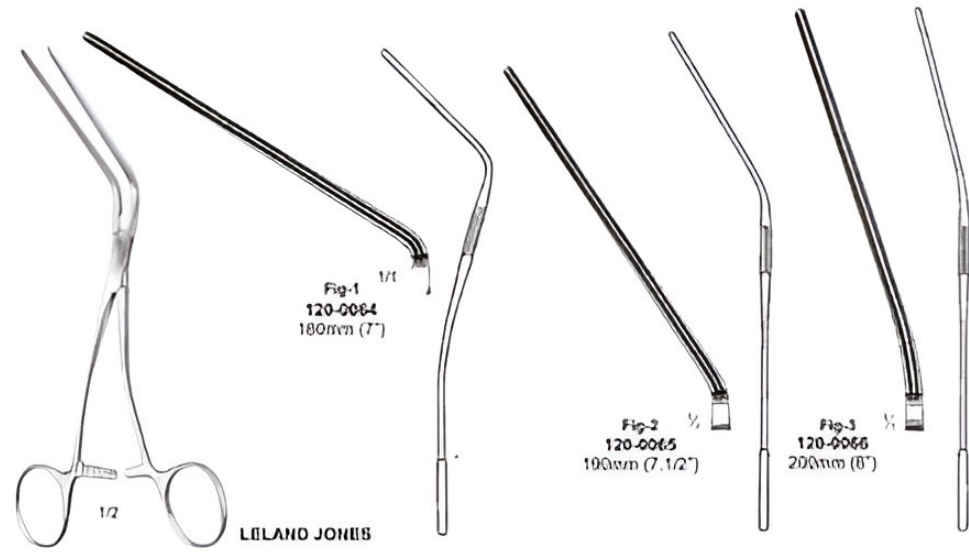

AUTRAUMA CARDIOVASCULAR FORCEPS

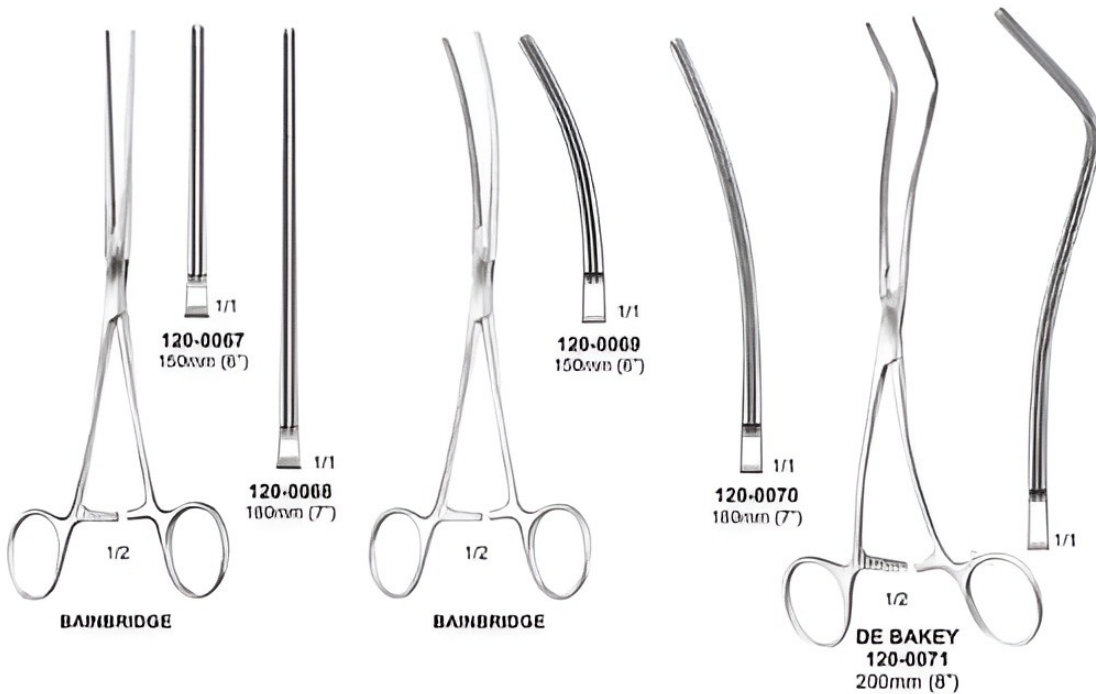

AUTRAUMA CARDIOVASCULAR FORCEPS



ANEURYSM CLAMP

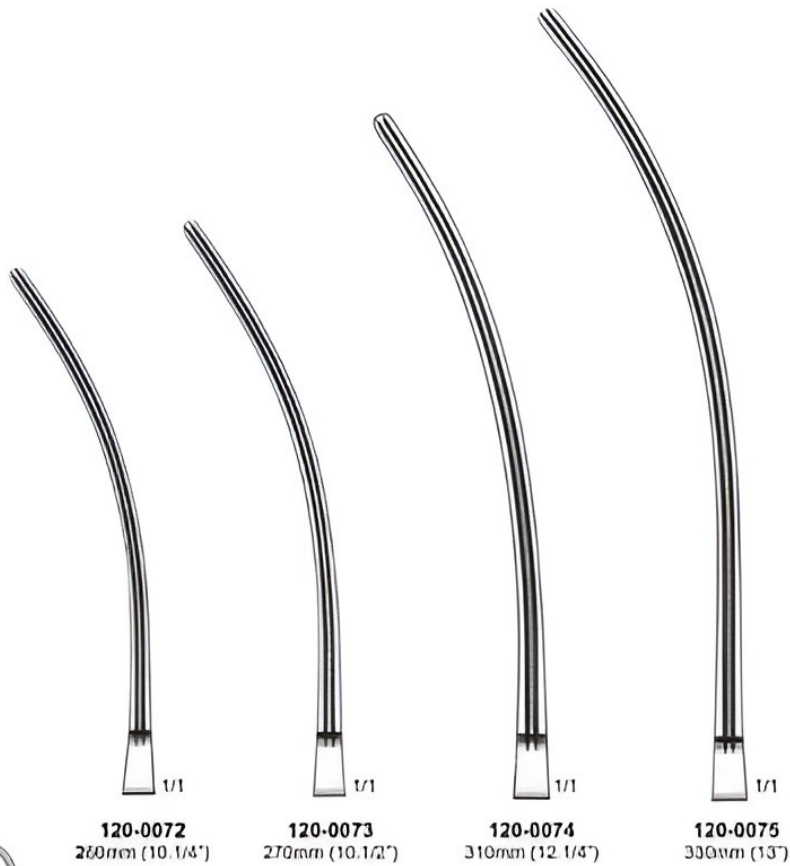

AUTRAUMA CARDIOVASCULAR FORCEPS



AUTRAUMA CARDIOVASCULAR FORCEPS



DE BAKAY
120-0070
280mm (10")



DE BAKAY
120-0080
250mm (10")

ATRAUMA CARDIOVASCULAR FORCEPS

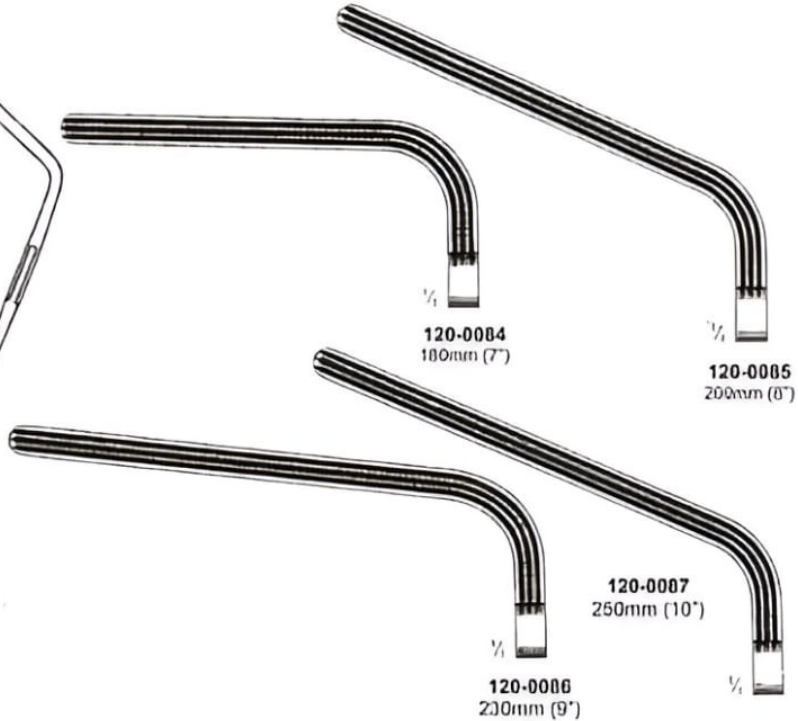
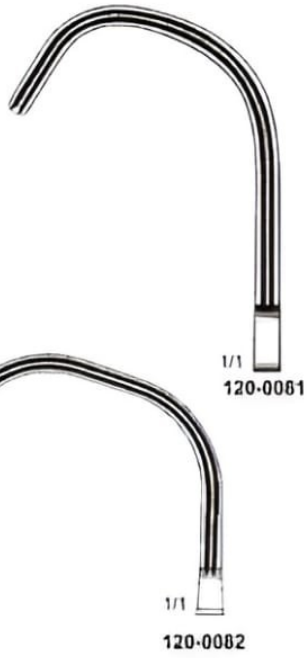

AUTRAUMA CARDIOVASCULAR FORCEPS

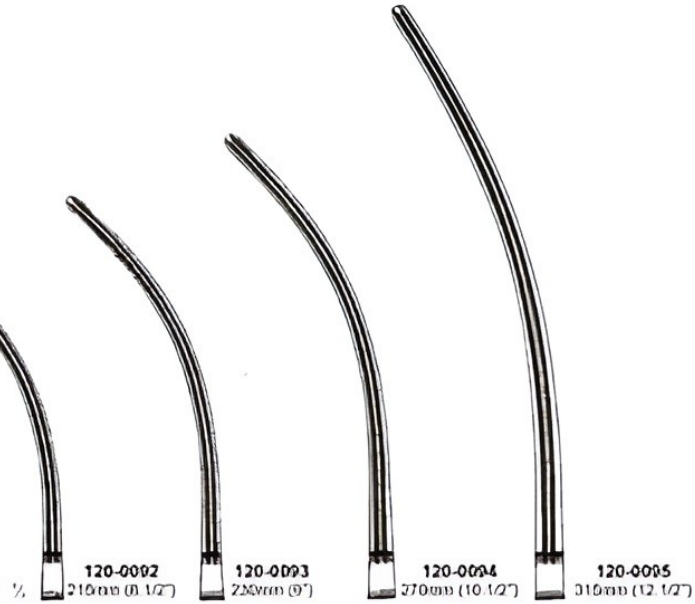
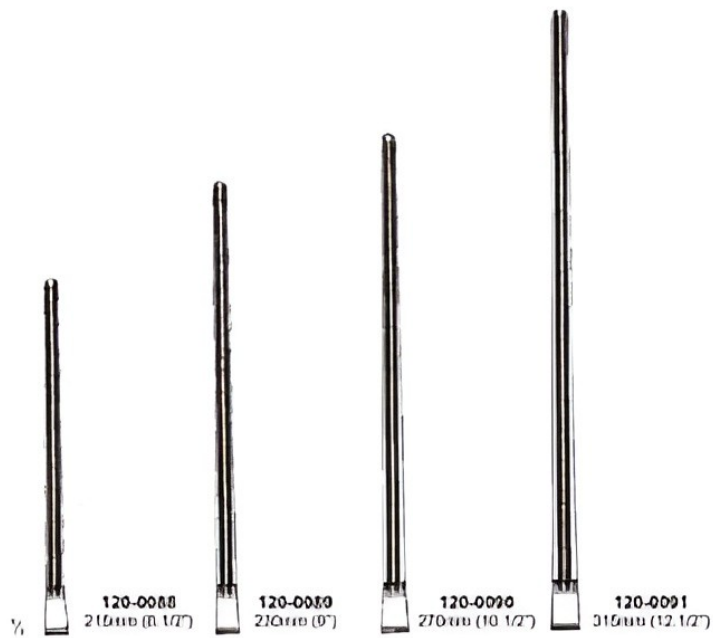

ATRAUMA CARDIOVASCULAR FORCEPS

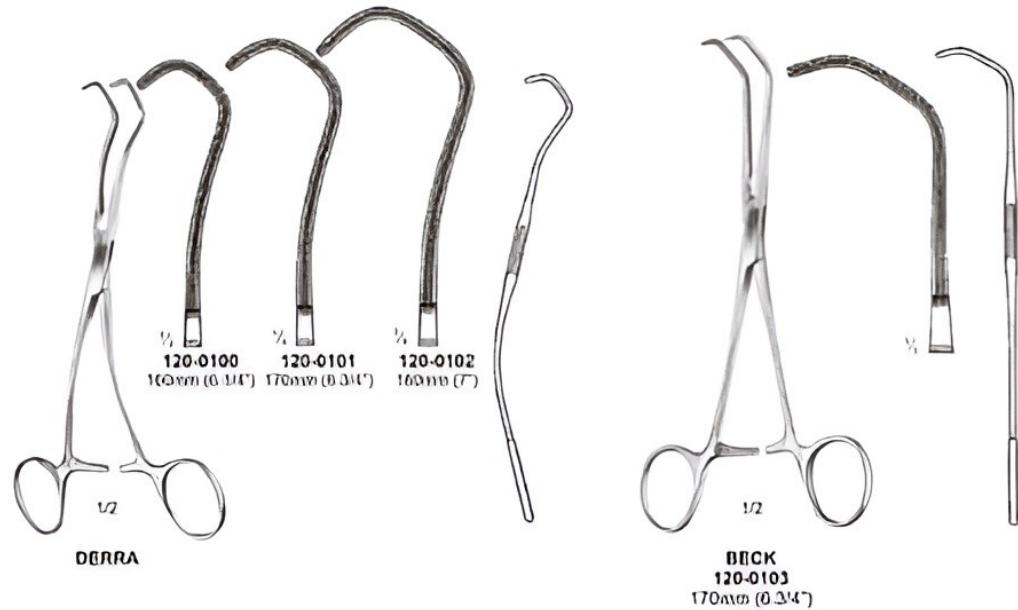
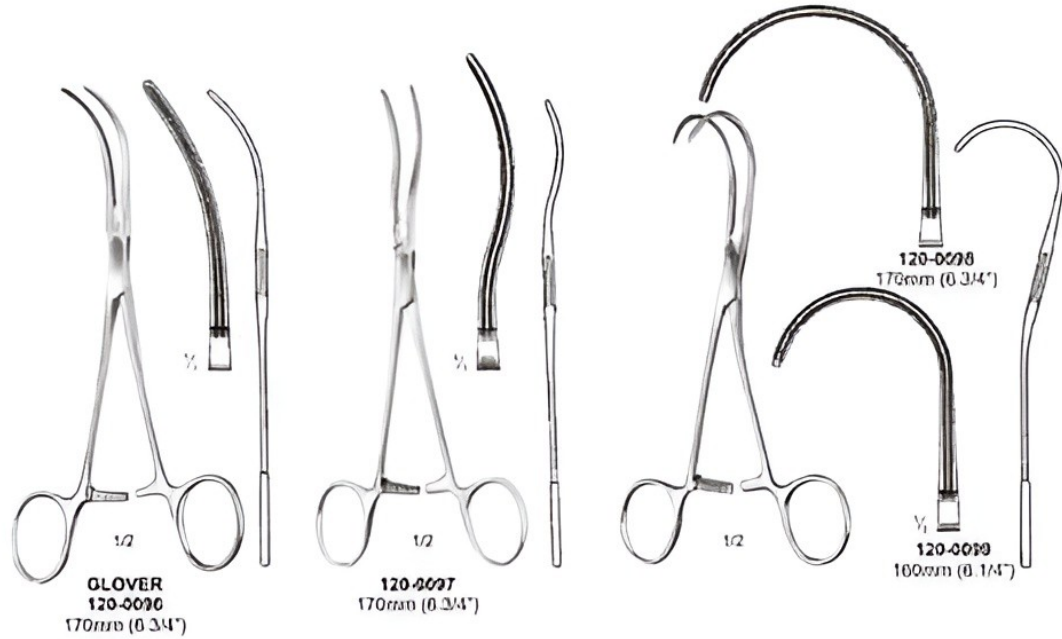

VASCULAR DILATORS

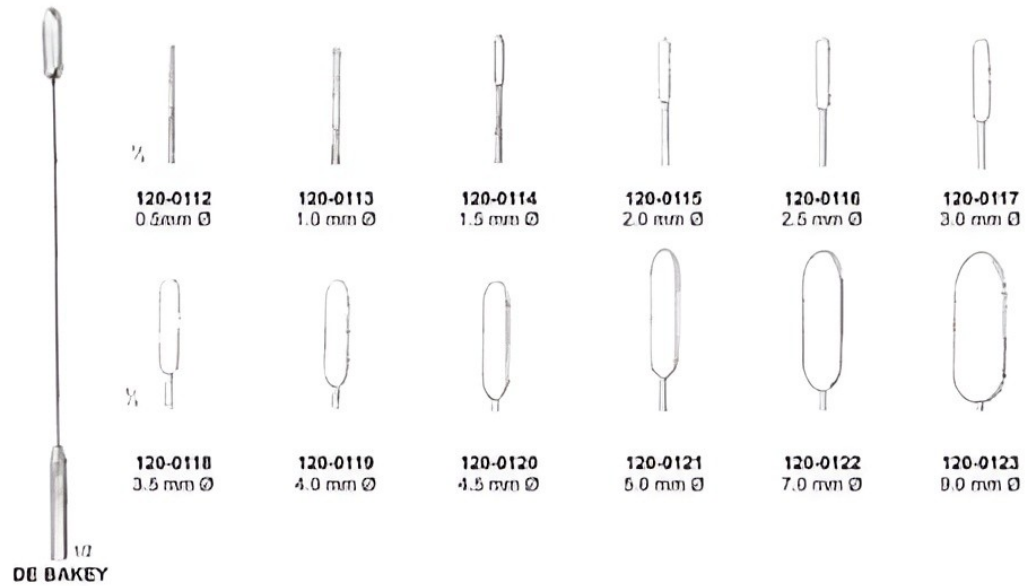
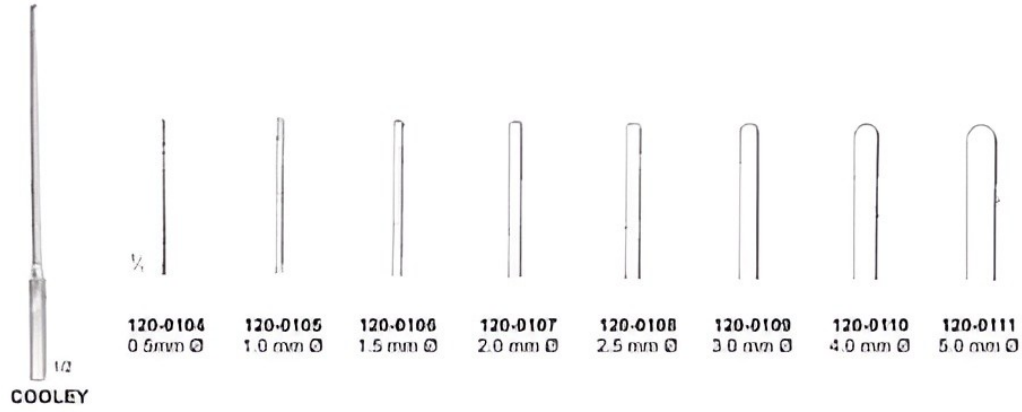

BIPOLAR FORCEPS



McPHERSON
121-0001
70mm
(2.74")
Straight



McPHERSON
121-0002
70mm
(2.74")
Angled



**JEWELER
FORCEPS**
121-0003
110mm
(4.14")
Straight



**JEWELER
FORCEPS**
121-0004
110mm
(4.14")
Angled



**JEWELER
FORCEPS**
121-0005
110mm
(4.14")
Curved



BIPOLAR FORCEPS
Straight
121-0006 160mm (6")
121-0007 180mm (7")
121-0008 200mm (8")
121-0009 220mm (8.1/2")
121-0010 240mm (9.1/2")

BIOPOLAR FORCEPS



**BIPOLAR FORCEPS
BAYONETT**
 121-0011 140mm (7")
 121-0012 240mm (9.5")
 121-0013 220mm (8.7")
 121-0014 240mm (9.5")



BIPOLAR FORCEPS
 ארוכה עם זווית
 121-0015 140mm (5.5")
 121-0016 180mm (7")
 121-0017 200mm (8")
 121-0018 220mm (8.7")
 121-0019 240mm (9.5")



**BIPOLAR FORCEPS
BAYONETT**
 ארוכה עם זווית
 121-0020 140mm (7")
 121-0021 180mm (8")
 121-0022 210mm (8.3")
 121-0023 240mm (9.5")



**BIPOLAR FORCEPS
BAYONETT**
 ארוכה עם זווית
 121-0024 140mm (7")
 121-0025 180mm (8")
 121-0026 210mm (8.3")
 121-0027 240mm (9.5")

MONOPOLAR CABLES, FORCEPS

MONOPOLAR CABLES



- 121-0028 3 meter cable, Hook connector, cable with active instrument connector
- 121-0029 5 meter cable, Hook connector, cable with active instrument connector

- 121-0030 3 meter cable, 4mm plug, cable with active instrument connector
- 121-0031 5 meter cable, 4mm plug, cable with active instrument connector

- 121-0032 3 meter cable, 8mm Jack plug (Bovie) cable with active instrument connector
- 121-0033 5 meter cable, 8mm Jack plug (Bovie) cable with active instrument connector



- DISSECTING FORCEPS**
121-0034
150mm (6")
100mm (7")
- DISSECTING FORCEPS**
121-0035
250mm (10")
250mm (10")
- MCINDOE FORCEPS**
121-0036
150mm (6")
- ADSON**
121-0037
100mm (7.125")



- WILSON HEY FORCEPS**
121-0039 110mm (7")
121-0040 230mm (9")
- 121-0041**
120mm (5")
- 121-0042**
150mm (6")
- 121-0043**
100mm (7")
- 121-0044**
200mm (8")
- 121-0045**
230mm (9")
- RICHES FORCEPS**

MONOPOLAR HANDLES, BLADES, NEEDLE, TURNER WARWICK SCISSORS



HANDLE
For cut and
plate electrode carriers
121-0040
17mm (0.14")



HANDLE
For needles and loops
121-0047
202mm (8")



HANDLE
For needles and loops
121-0048
167mm (6")



BLADES
121-0049
Large Diameter
blade electrode
(Insulated)



BLADES
121-0050
Large Diameter
blade electrode
(Insulated)



BLADES
121-0051
Small
Diameter
blade electrode



NEEDLE
121-0052
Short Sharp



NEEDLE
121-0053
Long Insulated



NEEDLE
121-0054
Long Sharp
Angled



NEEDLE
121-0055
Long Sharp
Straight



**TURNER WARWICK
SCISSOR**
121-0056 125mm (5")
121-0057 145mm (5.75")
121-0058 160mm (6")
121-0059 180mm (7")
121-0060 230mm (9")



SCALPPE HANDLE
121-0001
Red. Not

DISSECTION INSTRUMENTS



122-0001

- 1- BLOW PIPE
- 2- 3 PCS. SCALPEL
- 3- DISSECTING FORCEP 13 CM
- 4- GROOVED DIRECTOR WITH TONGUE TIE 13 CM
- 5- TRIPLE CHAIN HOOK
- 6- DRESSING SCISSORS PROBE POINTED 13 CM
- 7- PROBE DOUBLE 13 CM
- 8- ZIPPER CASE INSIDE RED VELVET.



122-0002

- 1- PROBE DOUBLE 13 CM
- 2- 2 PCS. SCALPEL S.S.
- 3- GROOVED DIRECTOR WITH TONGUE TIE 13 CM
- 4- MAYO HEGAR NEEDLE HOLDER 13CM
- 5- DISSECTING FORCEP 13 CM 1/2 TEETH
- 6- DRESSING FORCEP 13 CMS SERRATED.
- 7- DRESSING SCISSOR 13 CM S/B STR.
- 8- DRESSING SCISSOR 13 CM S/B CVD.
- 9- ZIPPER CASE INSIDE RED VELVET.

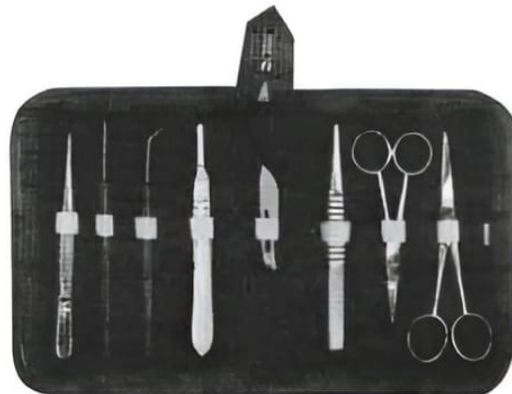

122-0003

- 1- DISSECTING FORCEP 11.5 CM SHARP POINT.
- 2- TEASING NEEDLE SHARP STR.
- 3- BP HANDLE NO 4
- 4- TEASING NEEDLE SHARP ANGULAR
- 5- BLADE NO 22
- 6- THUMB FORCEP T.O.E. 13 CM
- 7- DISSECTING SCISSOR STR 11.5 CM
- 8- DISSECTING SCISSOR STR 13 CM
- 9- ZIPPER CASE INSIDE RED VELVET.



122-0004

- 1- GROOVED DIRECTOR WITH TONGUE TIE 14 CM
- 2- PROBE DOUBLE 14CM
- 3- MAYO HEGAR NEEDLE HOLDER 14 CM
- 4- BP HANDLE NO 3
- 5- BP HANDLE NO 4
- 6- DRESSING SCISSOR 14 CM S/B STR
- 7- DRESSING SCISSOR 14 CM S/B CVD
- 8- DRESSING FORCEP 1/2 TEETH 14 CM
- 9- DRESSING FORCEP SERRATED 14 CM

DISSECTION INSTRUMENTS



- 122-0005**
 1- PROBE DOUBLE 12.5 CM
 2- SCALPEL
 3- B.P. HANDLE NO. 4
 4- 8 PCS BLADE 2 EACH NO. 21, 22, 23
 5- DISSECTING FORCEP 12.5 CM
 6- DISSECTING FORCEP 11.5 CM SHARP POINT
 7- DRESSING SCISSOR S/S STR. 13 CM
 8- DRESSING SCISSOR S/S STR. 13 CM



- 122-0000**
 1- TEASING NEEDLE WITH CHUCK CVD.
 2- HUBER PROBE
 3- IRIS SCISSOR
 4- DISSECTING FORCEP FINE 14 CM.
 5- DISSECTING FORCEP FINE CVD 12 CM.
 6- OPERATING SCISSOR WITH PROBE 14 CM.
 7- B.P. HANDLE NO. 4



- 122-0007**
 1- DISSECTING FORCEP FINE 14 CM.
 2- DISSECTING FORCEP FINE CVD 12 CM.
 3- DISSECTING FORCEP WITH PIN 14 CM.
 4- WATCHMAKER FINE POINT
 5- IRIS SCISSOR STR.
 6- IRIS SCISSOR CVD.
 7- TEASING NEEDLE HOLDER
 8- TEASING NEEDLE STR.
 9- B.P. HANDLE NO. 3



- 122-0008**
 1- TEASING NEEDLE STR.
 2- GROOVED DIRECTOR AND TONGUE TIE.
 3- TEASING NEEDLE CVD
 4- DISSECTING FORCEP WITH PIN 12 CM FINE
 5- OPERATING SCISSOR S/S STR. 14 CM
 6- TRIPLE CHAIN HOOK
 7- PROBE WITH EYE
 8- PROBE DOUBLE END
 9- PROBE AND HOOK
 10- DISSECTING FORCEP FINE 14 CM
 11- IRIS SCISSOR
 12- HUBER PROBE
 13- B.P. HANDLE NO. 3
 14- B.P. HANDLE NO. 4

DISSECTION INSTRUMENTS



122-0009

- 1- PROBE WITH EYE
- 2- DISSECTING FORCEP CVD FINE 12 CM.
- 3- IRIS SCISSOR
- 4- OPERATING SCISSOR SB STR 14 CM
- 5- GROOVED DIRECTOR AND TONGUE TIE
- 6- HUBER PROBE
- 7- TRIPLE CHAIN HOOK
- 8- B.P. HANDLE NO. 4
- 9- B.P. HANDLE NO. 3
- 10- TEASING NEEDLE WITH CHUCK CVD
- 11- TEASING NEEDLE WITH CHUCK STR.
- 12- DISSECTING FORCEPS FINE 14 CM



122-0010

- 1- PROBE DOUBLE END
- 2- GROOVED DIRECTOR AND TONGUE TIE
- 3- B.P. HANDLE NO. 4
- 4- OPERATING SCISSOR STR S/B 14 CM.
- 5- KELLY FORCEPS STR 14 CM.
- 6- DISSECTING FORCEPS THUMB 13 CAL.



122-0011

- 1- IRIS SCISSOR STR
- 2- DISSECTING FORCEP CVD FINE 12 CM
- 3- SCALPEL
- 4- TEASING NEEDLE STR WOODEN HANDLE
- 5- TEASING NEEDLE CVD WOODEN HANDLE
- 6- WATO MAKER FINE POINT



122-0012

- 1- DISSECTING FORCEP FINE STR WITH PIN 12 CM
- 2- IRIS SCISSOR STR
- 3- PROBE WITH EYE
- 4- PROBE AND HOOK
- 5- OPERATING SCISSOR SB STR 14 CM
- 6- TRIPLE CHAIN HOOK
- 7- B.P. HANDLE NO. 4
- 8- HUBER PROBE
- 9- B.P. HANDLE NO. 3
- 10- TASING NEEDLE STR PLASTIC HANDLE
- 11- TASING NEEDLE CVD PLASTIC HANDLE
- 12- GROOVED DIRECTOR AND TONGUE TIE
- 13- PROBE DOUBLE END

DISSECTION INSTRUMENTS



122-0013

- 1- GROOVED DIRECTOR AND TONGUE TIE
- 2- MAYO HEGAR NEEDLE HOLDER 14 CM
- 3- BP HANDLE NO 4
- 4- DISSECTING FORCEP THUMB 14 CM
- 5- OPERATING SCISSOR S/B STR 14 CM
- 6- KELLY FORCEP 14 CM STR
- 7- PROBE DOUBLE END



122-0014

- 1- DISSECTING FORCEP THUMB 14 CM
- 2- DISSECTING FORCEP 1/2 TEETH 14 CM
- 3- BP HANDLE NO 3
- 4- GROOVED DIRECTOR AND TONGUE TIE
- 5- MAYO HEGAR NEEDLE HOLDER 14 CM
- 6- OPERATING SCISSOR S/B STR 14 CM
- 7- PROBE DOUBLE END
- 8- KELLY FORCEP STR 14 CM



122-0015

- 1- PROBE DOUBLE END
- 2- BP HANDLE NO 4
- 3- DISSECTING FORCEP 1/2 TEETH 14 CM
- 4- OPERATING SCISSOR S/B 14 CM STR
- 5- MAYO HEGAR NEEDLE HOLDER 14 CM
- 6- KELLY FORCEP STR 14 CM
- 7- OPERATING SCISSOR S/B CVD 14 CM
- 8- GROOVED DIRECTOR AND TONGUE TIE
- 9- DISSECTING FORCEP THUMB 14 CM



122-0016

- 1- PROBE DOUBLE END
- 2- DISSECTING FORCEP 1/2 TEETH 14 CM
- 3- KELLY FORCEP CVD 14 CM
- 4- OPERATING SCISSOR S/B 14 CM CVD
- 5- MAYO HEGAR NEEDLE HOLDER 14 CM
- 6- BP HANDLE NO 4
- 7- OPERATING SCISSOR S/B 14 CM STR
- 8- KELLY FORCEP STR 14 CM
- 9- DISSECTING FORCEP THUMB 14 CM
- 10- GROOVED DIRECTOR AND TONGUE TIE

PATIENT CARE ITEMS



123-0001



123-0002



123-0008



123-0007



123-0000



123-0004



123-0003
123-0005

PATIENT TREATMENT ITEMS



TREATMENT ROOM ITEMS



THANK YOU



SURGIPROVE

SURGICAL EQUIPMENT SUPPLIERS



surgiprove@gmail.com



+923307020002



SURGIPROVE

SURGICAL SUPPLIERS

Dental instruments

ROOT ELEVATORS AND EXTRACTION SETS





Set - 01

KIT ROOT ELEVATORS
(Complete Set of 6 Pcs.)

- | | | |
|----|-----------------------|---------|
| 01 | ROOT ELEVATORS APICAL | Fig.301 |
| 02 | ROOT ELEVATORS APICAL | Fig.302 |
| 03 | ROOT ELEVATORS APICAL | Fig.303 |
| 04 | ROOT ELEVATORS SELDIN | Fig.34S |
| 05 | ROOT ELEVATORS CRYER | Fig.44 |
| 06 | ROOT ELEVATORS CRYER | Fig.45 |



Set - 03

INSTRUMENTS SET FOR EXTRACTION
(Complete Set of 9 Pcs.)

- | | | |
|----|-----------------------|----------|
| 01 | EXTRACTING FORCEPS | Fig. 67A |
| 02 | EXTRACTING FORCEPS | Fig. 51A |
| 03 | EXTRACTING FORCEPS | Fig. 33 |
| 04 | EXTRACTING FORCEPS | Fig. 79 |
| 05 | ROOT ELEVATORS FLOHR | Fig. 20 |
| 06 | ROOT ELEVATORS FLOHR | Fig. 238 |
| 07 | ROOT ELEVATORS FLOHR | Fig. 239 |
| 08 | ROOT ELEVATORS WINTER | Fig. 320 |
| 09 | ROOT ELEVATORS WINTER | Fig. 321 |



Set - 02



Set - 04



EXTRACTION AND ORAL SURGERY
(Complete Set of 9Pcs.)

- | | | |
|----|--------------------------|----------|
| 01 | EXTRACTING FORCEPS | Fig. 67A |
| 02 | EXTRACTING FORCEPS | Fig. 51A |
| 03 | EXTRACTING FORCEPS | Fig. 33 |
| 04 | EXTRACTING FORCEPS | Fig. 79 |
| 05 | ROOT ELEVATORS FLOHR | Fig. 20 |
| 06 | ROOT ELEVATORS FLOHR | Fig. 238 |
| 07 | ROOT ELEVATORS FLOHR | Fig. 239 |
| 08 | MAYO HEGAR NEEDLE HOLDER | 16 cm |
| 09 | MATHIEU NEEDLE HOLDER | 14 cm |



INSTRUMENTS SET FOR EXTRACTION
(Complete Set of 8 Pcs.)

- | | | |
|----|--------------------|----------|
| 01 | EXTRACTING FORCEPS | Fig. 1 |
| 02 | EXTRACTING FORCEPS | Fig. 17 |
| 03 | EXTRACTING FORCEPS | Fig. 18 |
| 04 | EXTRACTING FORCEPS | Fig. 79 |
| 05 | EXTRACTING FORCEPS | Fig. 67A |
| 06 | EXTRACTING FORCEPS | Fig. 51A |
| 07 | EXTRACTING FORCEPS | Fig. 13 |
| 08 | EXTRACTING FORCEPS | Fig. 22 |



Set - 05

INSTRUMENTS SET FOR EXTRACTION
(Complete Set of 8 Pcs.)

- 01 EXTRACTING FORCEPS Fig. 1
- 02 EXTRACTING FORCEPS Fig. 17
- 03 EXTRACTING FORCEPS Fig. 18
- 04 EXTRACTING FORCEPS Fig. 79
- 05 EXTRACTING FORCEPS Fig. 67A
- 06 EXTRACTING FORCEPS Fig. 51A
- 07 EXTRACTING FORCEPS Fig. 13
- 08 EXTRACTING FORCEPS Fig. 22



Set - 06

EXTRACTION FORCEPS FOR CHILDREN
(Complete Set of 10 Pcs.)

- 01 EXTRACTING FORCEPS FINO Fig. 37
- 02 EXTRACTING FORCEPS FINO Fig. 39
- 03 EXTRACTING FORCEPS FINO Fig. 39L
- 04 EXTRACTING FORCEPS FINO Fig. 39R
- 05 EXTRACTING FORCEPS FINO Fig. 51S
- 06 EXTRACTING FORCEPS FINO Fig. 13S
- 07 EXTRACTING FORCEPS FINO Fig. 30S
- 08 EXTRACTING FORCEPS FINO Fig. 33S
- 09 EXTRACTING FORCEPS FINO Fig. 22S
- 10 EXTRACTING FORCEPS FINO Fig. 38



Set - 07

INSTRUMENTS SET FOR EXTRACTING FORCEPS
(Complete Set of 10 Pcs.)

- 01 EXTRACTING FORCEPS Fig. 2
- 02 EXTRACTING FORCEPS Fig. 7
- 03 EXTRACTING FORCEPS Fig. 51A
- 04 EXTRACTING FORCEPS Fig. 17
- 05 EXTRACTING FORCEPS Fig. 18
- 06 EXTRACTING FORCEPS Fig. 67A
- 07 EXTRACTING FORCEPS Fig. 13
- 08 EXTRACTING FORCEPS Fig. 33
- 09 EXTRACTING FORCEPS Fig. 22
- 10 EXTRACTING FORCEPS Fig. 79



Set - 08

EXTRACTING FORCEPS SET FOR CHILDREN KLEIN PATTERN
(Complete Set of 7 Pcs.)

- 01 EXTRACTING FORCEPS CHILDREN Fig. 5
- 02 EXTRACTING FORCEPS CHILDREN Fig. 6
- 03 EXTRACTING FORCEPS CHILDREN Fig. 7
- 04 EXTRACTING FORCEPS CHILDREN Fig. 137
- 05 EXTRACTING FORCEPS CHILDREN Fig. 139
- 06 EXTRACTING FORCEPS CHILDREN Fig. 3
- 07 EXTRACTING FORCEPS CHILDREN Fig. 51S



A pair of surgical forceps is shown in a dark, moody setting. The forceps are positioned diagonally across the frame, with the handles extending towards the bottom left and the jaws pointing towards the top right. The background is a dark, textured surface, possibly a surgical drape or a table. The lighting is dramatic, highlighting the metallic sheen of the forceps and creating deep shadows. Overlaid on the image is the text 'EXTRACTING FORCEPS' in a bold, white, sans-serif font, centered horizontally and vertically.

EXTRACTING FORCEPS



201-0001
Fig.1
Upper centrals
& canines



201-0002
Fig.2
Upper laterals
& becuspids
& bicuspid



201-0003
Fig.3
Upper incisors
& canines



201-0004
Fig.4
Lower incisors
& canines



201-0005
Fig.7
Upper primolars



201-0006
Fig.8
Lower primolars



201-0007
Fig.13
Lower primolars



201-0008
Fig.17
Right upper molars



201-0009
Fig.18
Left upper molars



201-0010
Fig.18A
Upper molars



201-0011
Fig.18A
Upper wisdoms



201-0012
Fig.20
Lower wisdoms



201-0013
Fig.21
Lower molar



201-0014
Fig.22
Lower molars
Hawk's bills



201-0015
Fig.23
Right lower molars



201-0016
Fig.24
Left lower molars



201-0017
Fig.29
Upper root & incisors



201-0022
Fig.33
Lower roots



201-0023
Fig.33A
Lower roots



201-0024
Fig.33C
Lower roots



201-0025
Fig.33M
Lower roots with long beak

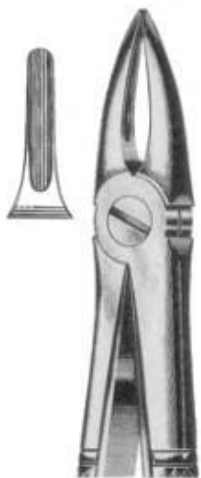

201-0018
Fig.29N
Roots of upper incisors



201-0019
Fig.30
Upper roots & incisors

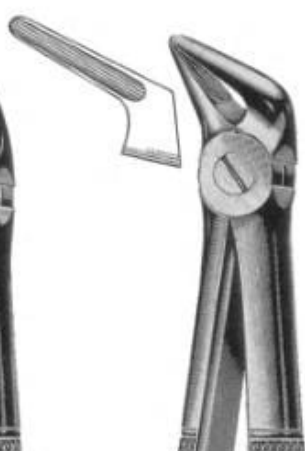

201-0020
Fig.31
Lower roots



201-0021
Fig.32
Lower molars



201-0026
Fig.41
Upper roots

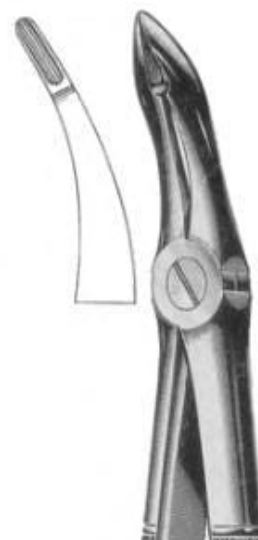

201-0027
Fig.44
Upper roots

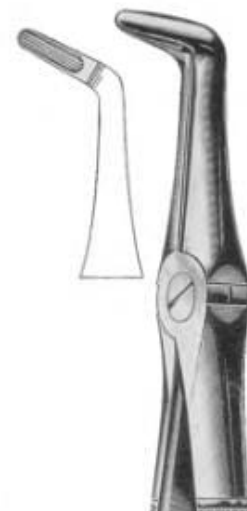

201-0028
Fig.45
Lower roots

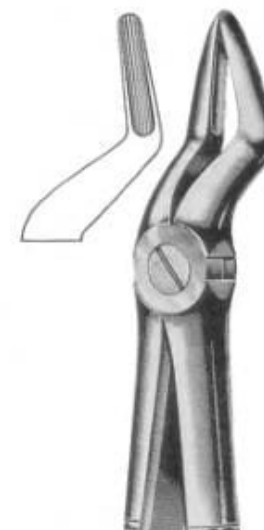

201-0029
Fig.51
Upper roots



201-0030
Fig.51A
Upper roots narrow beak



201-0031
Fig.51C
Upper roots

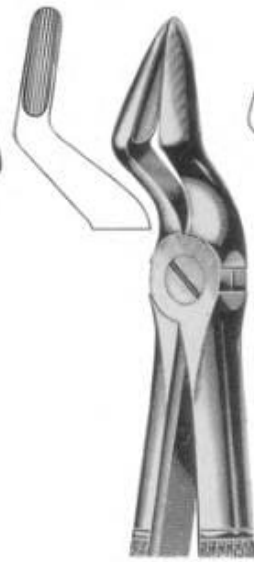

201-0032
Fig.52
Upper roots & canines
with wider beak

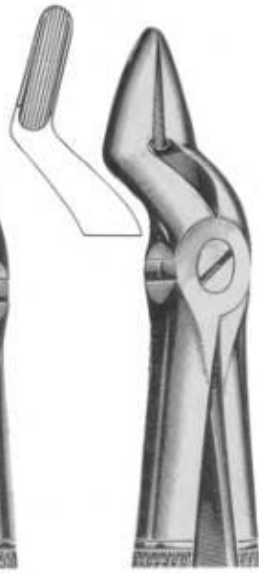

201-0033
Fig.52A
Upper teeth & resection



201-0034
Fig.55
Separating upper molars roots



201-0035
Fig.56
Separating lower molars roots



201-0036
Fig.67
Upper wisdoms

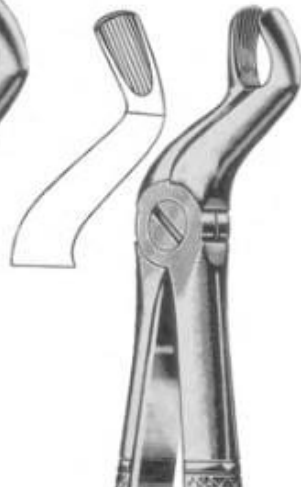

201-0037
Fig.67A
Upper wisdoms



201-0038
Fig.68
Lower roots



201-0039
Fig.73
Lower molars (hawk's bill)



201-0040
Fig.74
Lower incisors & roots



201-0041
Fig.74M
Lower incisors & roots



201-0042
Fig.74N
Lower incisors & roots



201-0043
Fig.75
Lower premolars & canines



201-0044
Fig.76
Upper roots



201-0045
Fig.76N
Upper roots
Narrow break



201-0046
Fig.79
Lower wisdoms



201-0047
Fig.79A
Lower wisdoms



201-0048
Fig.86A
Lower molars



201-0049
Fig. 86B
Lower molars



201-0050
Fig.86C
Lower molars

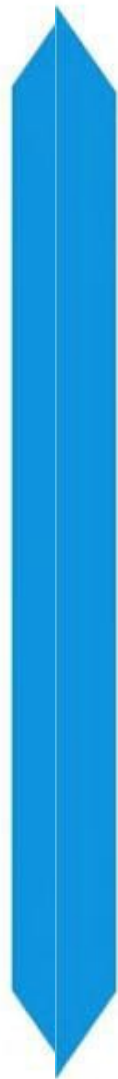

201-0054
Fig.94
Right upper molars

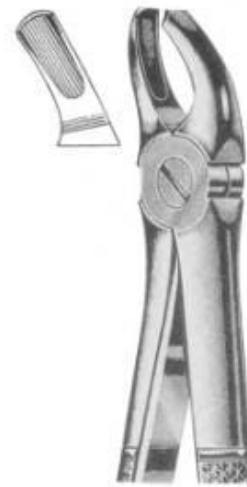

201-0055
Fig.95
Left upper molars



201-0056
Fig.99
Lower molars
(broken-down)



201-0057
Fig.99 1/4
Lower molars
(broken-down)



201-0051
Fig.87
Cowhorn beak



201-0052
Fig.89
Right upper molars



201-0053
Fig.9
Left upper molars



201-0058
Fig.121
Upper wisdoms



201-0059
Fig.136
Upper centrals
& roots



201-0060
Fig.137
Lower centrals
& roots

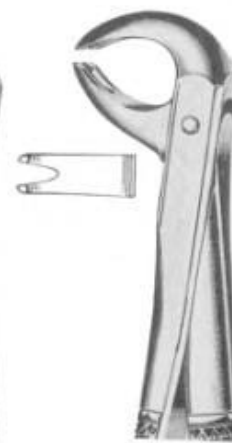

201-0061
Fig.167
Universal pincer
for lower teeth
molars & premolars



201-0062
Fig.168
Upper canines

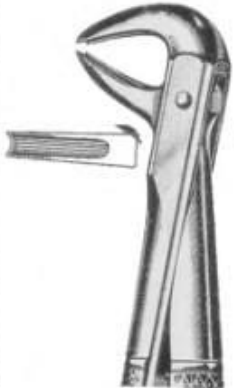

201-0063
Fig.169
Lower canines & premolars



201-0064
Fig.233
Lower roots (parallel beaks)



201-0065
Fig.235
Lower roots (parallel beaks)



201-0066
Fig.MD 1
Universal forceps for upper wisdoms, premolars & roots

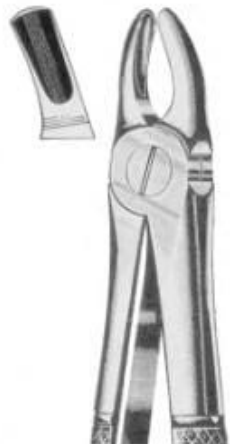

201-0067
Fig.MD 2
Upper molars



201-0068
Fig.MD 3
Lower incisors, premolars & roots



201-0069
Fig.MD 4
Lower molars

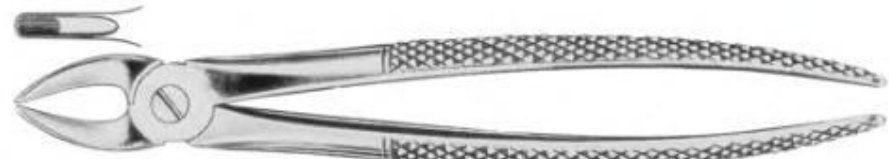

201-0070
Fig.37
Children's upper incisors & canines

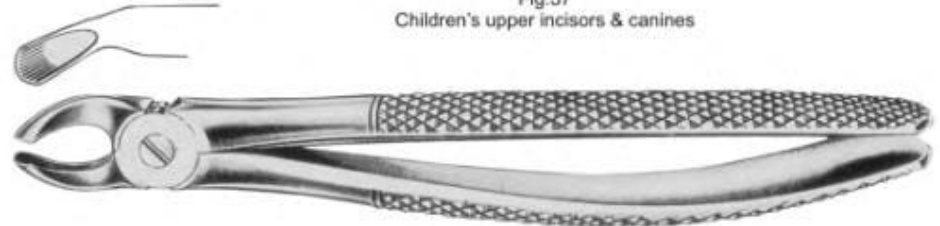

201-0071
Fig.39
Children's upper molars & universal

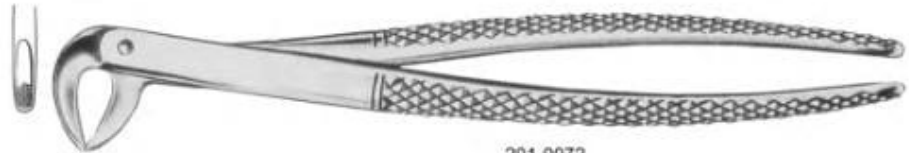

201-0072
Fig.123
Children's lower teeth universal



201-0073
Fig.138
Children's upper universal & roots

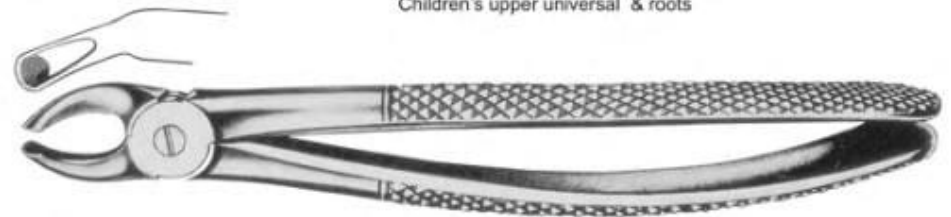

201-0074
Fig.157
Children's upper molars universal



201-0075
Fig.158
Children's upper teeth molars universal

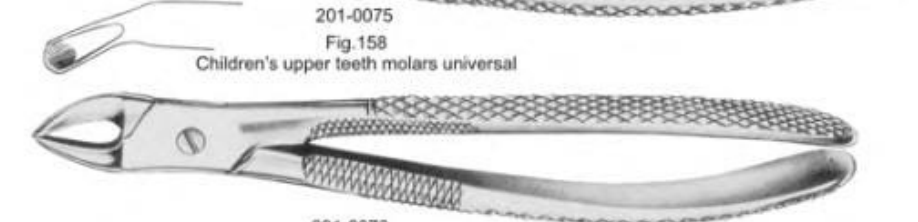

201-0076
Fig.159
Children's lower molars universal



201-0077
Fig.160
Children's upper lower universal (hawk's bill)



201-0078
Fig.161
Children's lower & roots

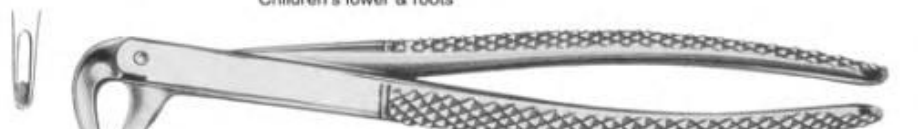

201-0079
Fig.162
Children's upper centrals

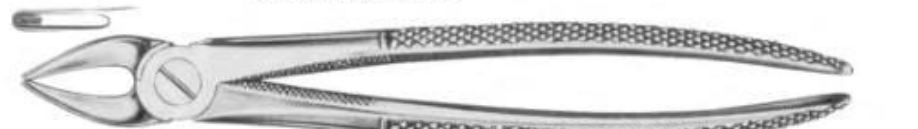

201-0080
Fig.163
Children's upper centrals



201-0081
Fig. 3
Upper molars



201-0082
Fig. 5
Lower incisors



201-0083
Fig. 6
Lower molars



201-0084
Fig. 7
Lower roots



201-0085
Fig.137
Upper incisors
& canines



201-0086
Fig.139
Upper premolars



201-0087
Fig.51S
Upper roots



201-0088
Universal pattern for upper teeth



201-0089
Universal pattern for lower teeth



201-0090
Fig. 22 1/2 L
Left lower wisdoms & molars



201-0091
Fig. 22 1/2 R
Right lower wisdoms & molars



201-0092
Fig. 1
Upper centrals, laterals & cuspids

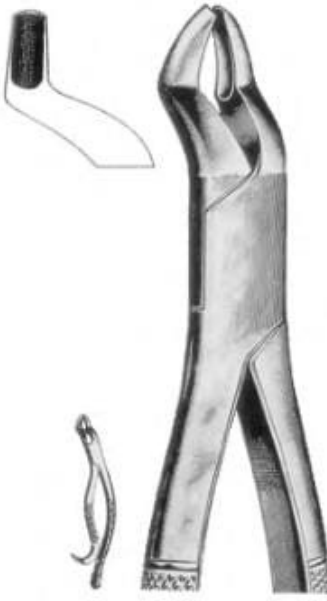

201-0093
Fig. 5
Lower third molars

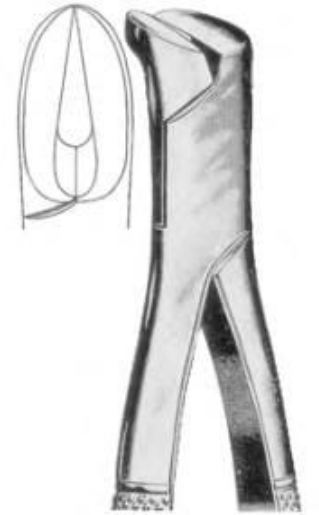

201-0094
Fig. 6
Splitting forceps

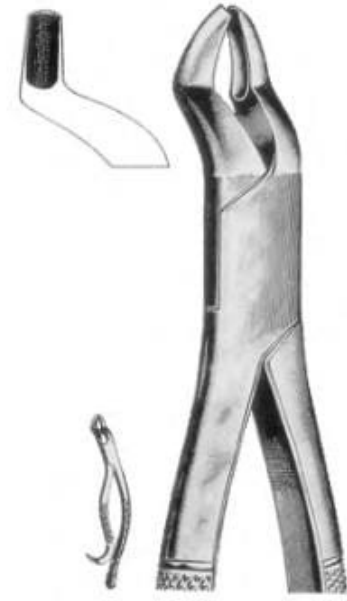

201-0095
Fig. 10 H
Upper molars hook-handle



201-0096
Fig. 10 S
Upper molars straight-handle



201-0097
Fig. 15
Lower molars



201-0098
Fig. 16 S
Lower molars children's



201-0099
Fig. 16
Lower molars (cow-horn beak)
201-0100
Fig.16 SK



201-0101
Fig. 17
Lower molars
201-0102
Fig.17 SK



201-0105
Fig. 18R
Upper molars right side
201-0106
Fig.18R SK



201-0103
Fig. 18L
Upper molars left side
201-0104
Fig.18L SK



201-0107
Fig. 23
Lower molars (cow-horn beak)
201-0108
Fig.23 SK



201-0109
Fig. 32
Upper molars & pre molars
strong beak
201-0110
Fig. 32 SK



201-0115
Fig. 62
Universal forceps
for upper teeth & roots
201-0116
Fig. 62 SK



201-0111
Fig. 53 L
Upper molars left side
201-0112
Fig. 53 L SK



201-0117
Fig. 65
Upper Incisors & root
201-0118
Fig. 65 SK



201-0113
Fig. 53 R
Upper molars right side
201-0114
Fig. 53R SK



201-0119
Fig. 69
Fragments & small roots
Upper & lower
201-0120
Fig. 69 SK

AMERICAN PATTERN



201-0121
Fig. 88 R
Right upper molars
201-0122
Fig. 88 R SK



201-0123
Fig. 88L
Left upper molars
201-0124
Fig. 88L SK



201-0125
Fig. 99C
Upper Premolars,
Molar & incisors
201-0126
Fig. 99C SK



201-0127
Fig. 101
Universal forceps
for premolars
201-0128
Fig. 101 SK



201-0129
Fig. 150
Upper premolars,
incisors & roots
201-0130
Fig. 150 SK



201-0131
Fig. 150A
Upper premolars incisors & roots
201-0132
Fig. 150A SK



201-0133
Fig. 150S
Upper premolars incisors & roots
for children
201-0134
Fig. 150 SK



201-0135
Fig. 151
Lower premolars, incisors & roots
201-0136
Fig. 151 SK



201-0137
Fig. 151A
Lower premolars, incisors & roots
201-0138
Fig. 151A SK



201-0139
Fig. 151S
Lower premolars, incisors & roots
for children's
201-0140
Fig. 151 SK

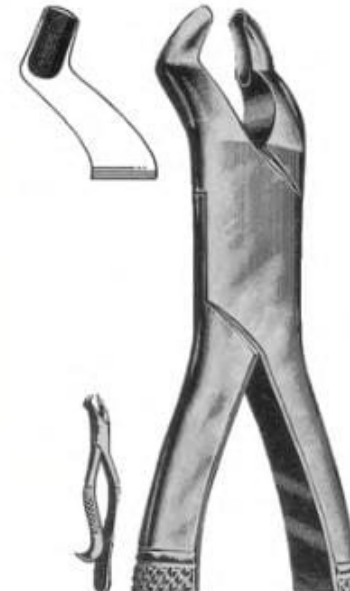

201-0141
Fig. 210H
Upper wisdoms with
hook handle
201-0142
Fig. 210H SK

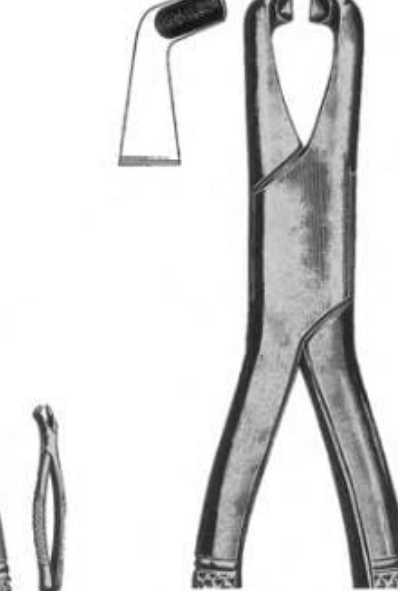

201-0143
Fig. 210S
Upper wisdoms with
straight handle
201-0144
Fig. 210 SK

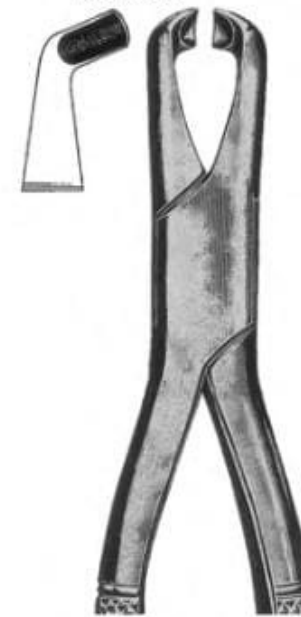

201-0145
Fig. 222
Lower wisdoms
201-0146
Fig. 222 SK



201-0147
Fig. 286
Upper roots, premolars & incisors
201-0148
Fig. 286 SK



201-0149
Fig. 1
Lower roots



201-0150
Fig. 2
Upper roots



201-0151
Fig. 44
201-0152
Fig. 44 SK



201-0153
Albrecht 16cm



201-0154
Albrecht 16cm

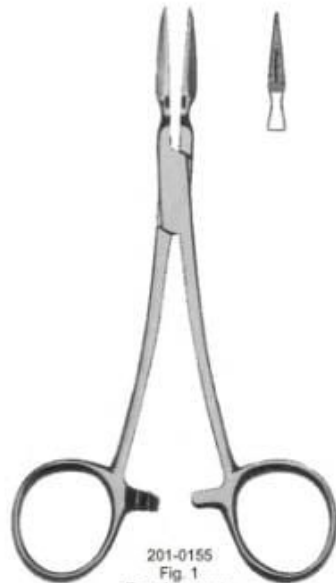

201-0155
Fig. 1
Root fragments



201-0156
Fig. 2
Root fragments



PLIERS FOR ORTHODONTICS & PROSTHETIC



202-0009
Flat Pliers
14cm



202-0010
14cm



202-0011
14cm



202-0012
14.5cm



202-0013
14.5cm



202-0014
14cm



202-0015
14cm



202-0016
14cm



202-0017
Serrated jaws
12cm



202-0001
Waldsachs
15cm



202-0002
Universal
16cm



202-0003
Nance
13.5



202-0018
How
14.5cm



202-0019
How-angled
14.5cm



202-0020
Arrow clasp forming
12cm



202-0021
Arrow clasp forming
12cm



202-0022
Arrow clasp bending
12cm



202-0004
Aderer
14.5cm



202-0005
Model marburg
Serrated jaws
14cm



202-0006
Model marburg
Smooth jaws
14cm



202-0007
Model marburg
Carbide inserts jaws
14cm



202-0008
Goslee
One Serrated jaws
14cm



202-0023
Peeso
13.5cm



202-0024
Peeso
13.5cm



202-0025
14cm



202-0026
Langenbeck
14cm



202-0034
Aderer
12cm



202-0035
Aderer-Heavy
12cm



202-0036
Tweed
14.5cm



202-0037
O'brien
13.5cm



202-0027
Jarabak
14cm



202-0028
Bending Plier
13cm



202-0029
Angle
12.5cm



202-0038
Wire bending pliers
12.5cm



202-0041
Young
14cm



202-0042
Clasp forming
14cm



202-0030
Andresen
13cm

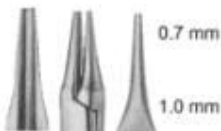

202-0031
Bending Plier
13.5cm



202-0032
Schwarz
13.5cm



202-0033
Fischer
13cm



202-0039
Adams
12.5cm



202-0040
frevert
12.5cm



202-0043
Hard Wire Cutter
5 1/2" (14 cm)



202-0044
Arch Forming Plier
5 1/2" (14 cm)



202-0045
Medium Size Bending Pliers
5 1/2" (14 cm)



202-0052
Bracket Removing Pliers
5 1/2" (14 cm)



202-0053
Bracket Removing Pliers
5 1/2" (14 cm)



202-0054
Bracket Removing Pliers
5 1/2" (14 cm)



202-0046
Aderer Pliers
5 1/2" (14 cm)



202-0047
Wire Bending Plier
5 1/2" (14 cm)



202-0048
Round & Concave Plier
5 1/2" (14 cm)



202-0055
Bracket Removing Pliers
5 1/2" (14 cm)



202-0056
Bracket Removing Pliers
5 1/2" (14 cm)



202-0057
Flat Pliers
5 1/2" (14 cm)



202-0049
Aderer Pliers
with narrow standing points,
for bending wires up to a 0.5mm,
disinfectable, sterilizable
4 1/2" (12cm)



202-0050
Aderer Pliers
for bending wires up to a 0.9mm,
disinfectable, sterilizable
4 1/2" (12cm)



202-0051
Bending plier for lingual cleat
5 1/2" (14 cm)



202-0058
Nance Closing Loop Pliers
5 1/2" (14 cm)



202-0059
Angle Bending Pliers
5 1/2" (14 cm)



202-0060
Crown Crimping Pliers
5 1/2" (14 cm)



202-0061
Round & Flat Plier
5 1/2" (14 cm)



202-0062
Tweed Angle Arch Bending
5 1/2" (14 cm)



202-0063
Band Removing Pliers
5 1/2" (14 cm)



202-0070
Flat Nose Plier
5 1/2" (14 cm)



202-0071
How Pliers
5 1/2" (14 cm)



202-0072
Gordon - Contouring
5 1/2" (14 cm)



202-0064
Johnson Contouring Pliers
5 1/2" (14 cm)



202-0065
Round Nose Pliers
5 1/2" (14 cm)



202-0066
Tweed Angle Arch Bending
5 1/2" (14 cm)



202-0073
Adams Pliers
5 1/2" (14 cm)



202-0074
Adams Pliers
5 1/2" (14 cm)



202-0075
Tweed Pliers
5 1/2" (14 cm)



202-0067
De La Rosa Pliers
5 1/2" (14 cm)



202-0068
Arch Forming Plier
5 1/2" (14 cm)



202-0069
Tweed Angle Arch Bending
5 1/2" (14 cm)



202-0076
Bending Pliers
mediumfine, with graduation,
for wires up to 1.0mm
5 1/2" (14cm)



202-0077
Special pliers
max .022" x .028"
5 1/2" (14cm)



202-0078
Pliers for operating the Mobil-Stop
5 1/2" (14cm)



202-0079
Light wire pliers for wires
up to \varnothing 0.60mm
with cutter Begg
4 1/2" (12cm)



202-0080
Weingart Universal Pliers
5 1/2" (14 cm)



202-0084
Distel Cutter Light Weight
5 1/2" (14 cm)



202-0085
Distel Cutter medium
5 1/2" (14 cm)



202-0086
Ligature Pin Cutter
5 1/2" (14 cm)



202-0081
Weingart ultra lightwire Pliers
5 1/2" (14 cm)



202-0082
Weingart Universal lightwire Pliers
max .022" x .028
5 1/2" (14cm)



201-0087
Hard Wire Cutter
5 1/2" (14 cm)



202-0088
Hard Wire Cutter
5 1/2" (14 cm)



202-0089
Bracket Removing Pliers
5 1/2" (14 cm)



202-0083
Universal Facebow Pliers
6 1/2" (16.5cm)



202-0090
Arch torquing and bending pliers
for wires up to \varnothing 0.60mm
allow to use a pair
4 1/2" (12cm)





CARBIDE INSERTED PLIERS



203-0001
BEYER
150mm (6")
5mm bite

203-0002
JANSEN-MIDDLETON
SEPTUM FORCEPS
200mm (8") Spoon shaped
4mm bite

203-0003
CAIRNS
140mm (5.1/2")
4mm bite

203-0004
CAIRNS
140mm (5.1/2")
4mm bite

203-0005
LUER
155mm (6")

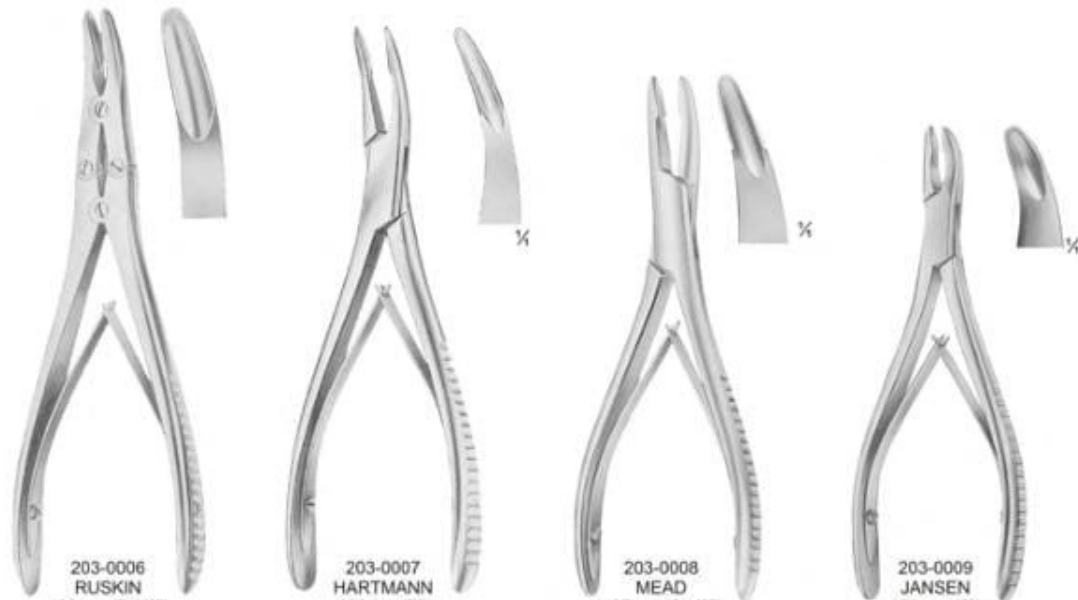

203-0006
RUSKIN
190mm (7.1/2")
6mm bite

203-0007
HARTMANN
180mm (7")

203-0008
MEAD
165mm (6.1/2")

203-0009
JANSEN
150mm (6")



BONE RONGEURS



203-0010
TROTTER
200mm (8")
10mm bite



203-0011
SYNOVECTOMY
RONGEUR
175mm (7")



203-0012
HEANLEY
175mm (7")
4mm bite



203-0013
PENNYBACKER
200mm (8")
4mm bite



203-0014
SYNOVECTOMY
RONGEUR
130mm (5.1/8")
Jaw width 2mm



203-0015
NORTHFIELD
200mm (8")
10mm bite



203-0016
WILMS
200mm (8")
4mm bite



LEKSELL
203-0017
240mm
(9.1/2")
6mm bite
203-0018
240mm
(9.1/2")
8mm bite



203-0019
LUER-JANSEN
170mm (6.3/4")
4mm bite



203-0020
BEYER
180mm (7")



203-0021
BEYER
200mm (8")



203-0022
KILLEARN
197mm (7.3/4")
3mm bite



203-0023
ZAUFAL-JANSEN
240mm (9.1/2")



203-0024
ECHLIN
240mm (9.1/2")



203-0025
NORTHFIELD
225mm (9") 10mm bite



203-0026
SARGENT (VAN HAVRE)
220mm (8.3/4")
10mm bite



203-0027
OLIVECRONA
230mm (9")
6mm bite



203-0028
STILLE-RUSKIN
240mm (9.1/2")

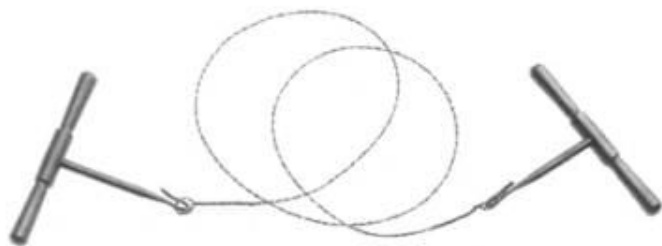

203-0029
GIGLI SAW WITH HANDLE
500mm (20")



203-0030
RUDOR EDWARDS COSTOTOME
230mm (9")



ROOT ELEVATOR

surgiprove@gmail.com



204-0001
Fig. 1B
Bein



204-0002
Fig. 2B
Bein



204-0003
Fig. 3B
Bein



204-0004
Fig. 4B
Bein



204-0005
Fig. 5B
Bein



204-0006
Fig. 6B
Bein



204-0007
Fig. 4SA
Schmeckebeier-Apexo

204-0008
Fig. 5SA



204-0009
Fig. 34S
Seldin



204-0010
Fig. 34
Seldin



204-0011
Fig. 2S
Seldin



204-0012
Fig. 3S
Seldin



204-0013
Fig. 1F
Flohr



204-0014
Fig. 2F
Flohr



204-0015
Fig. 3F
Flohr



204-0016
Fig. 71
Miller-Apexo



204-0017
Fig. 72
Miller-Apexo



204-0018
Fig. 73
Miller-Apexo



204-0019
Fig. 74
Miller-Apexo



204-0020
Fig. 19



204-0021
Fig. 20



204-0022
Fig. 51
Curtis



204-0023
Fig. 52
Curtis



204-0024
Fig. 1L
Seldin



204-0025
Fig. 1R
Seldin



204-0026
Fig. 4L
Seldin



204-0027
Fig. 4R
Seldin



204-0028
Fig. 11
Stout



204-0029
Fig. 11A
Stout



204-0030
Fig. 44C
Stout



204-0031
Fig. A
Cogswell



204-0032
Fig. B
Cogswell



204-0033
Fig. 301
Apexo



204-0034
Fig. 302
Apexo



204-0035
Fig. 303
Apexo



204-0036
Fig. 301W
Seldin



204-0037
Fig. 304W
Seldin



204-0038
Fig. 1H
Heidbrink



204-0039
Fig. 2H
Heidbrink



204-0040
Fig. 40H
Heidbrink



204-0041
Fig. 41H
Heidbrink



204-0042
Fig. 46



204-0043
Fig. 46R



204-0044
Fig. 44
Cryer



204-0045
Fig. 45
Cryer

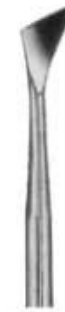

204-0046
Fig. 25
Cryer



204-0047
Fig. 26
Cryer



204-0048
Fig. 31
Cryer



204-0049
Fig. 32
Cryer



204-0050
Fig. 80



204-0051
Fig. 81



204-0052
Fig. 81A



204-0053
Fig. 81E



204-0054
Fig. 190



204-0055
Fig. 191



204-0056
Fig. 23



204-0057
Fig. 24



204-0058
Fig. 98

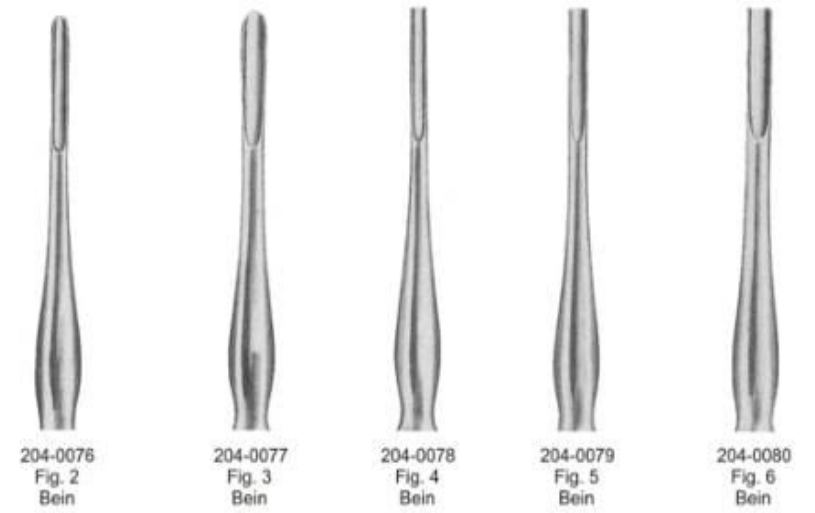
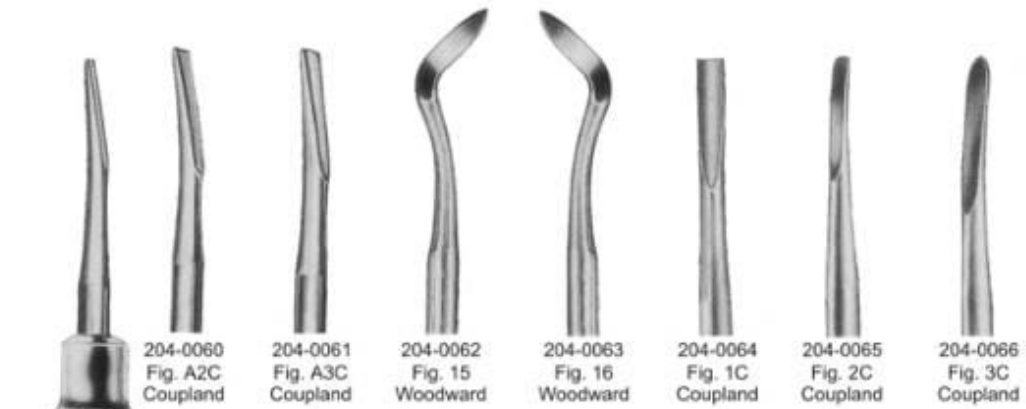

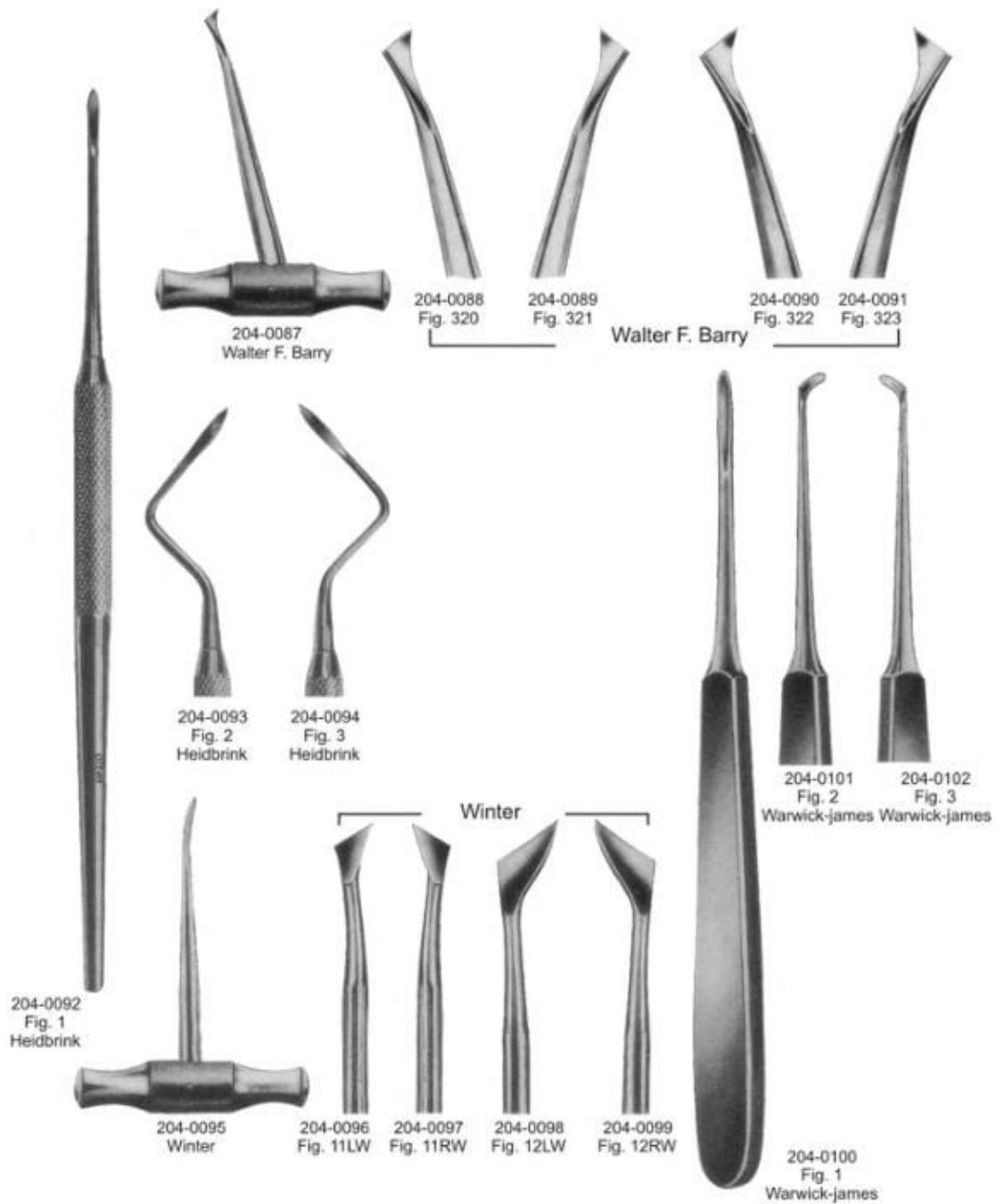

The background of the slide features a pair of dental forceps and a dental mirror. The forceps are positioned horizontally across the middle, with their handles extending towards the right. The dental mirror is located on the left side, with its circular head partially visible. The entire scene is set against a dark, textured background, possibly a dental chair or a work surface, which is dimly lit, creating a professional and clinical atmosphere.

ORTHODONTICS INSTRUMENTS

surgiprove@gmail.com



A close-up photograph of a surgeon wearing blue scrubs and a surgical mask. The surgeon is holding a pair of gum scissors, which are a specialized surgical instrument. The background is slightly blurred, showing other people in the operating room.

GUM SCISSORS

surgiprove@gmail.com



206-0001
Fig. 1
12cm Straight



206-0002
Fig. 2
12cm curved



206-0003
Fig. 1
13cm
Goldman-Fox
Saw edge
Straight



206-0004
Fig. 2
13cm
Goldman-Fox
Saw edge
curved



206-0005
Fig. 1
11.5cm
Iris Straight



206-0006
Fig. 2
11.5cm
Iris
Curved



206-0007
Fig. 3
11.5cm
Iris



206-0008
Fig. 1
11.5cm
Angular Saw edge



206-0009
Fig. 2
11.5cm
Angular



206-0014
Fig. 1
Kelly
16cm

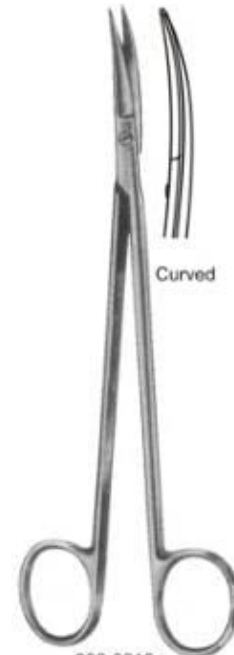

206-0015
Fig. 2
Kelly
16cm



206-0016
Fig. 1
Locklin
16.5 cm



206-0017
Fig. 2
Locklin
16.5cm



206-0010
Fig. 1
La Grange
11.5cm



206-0011
Fig. 1
Quinby
12.5cm



Straghit



206-0012
Fig. 2
Quinby
12.5cm



Curved



206-0013
Fig. 3
Goldman-Fox (Special)
saw edge
12.5cm

A collection of surgical instruments, including various types of scissors, forceps, and probes, are arranged on a dark, textured surface. The instruments are rendered in a dark, monochromatic style, with some highlights suggesting their metallic nature. The background is a dark teal color with a subtle grid pattern.

SURGICAL SCISSORS

surgiprove@gmail.com

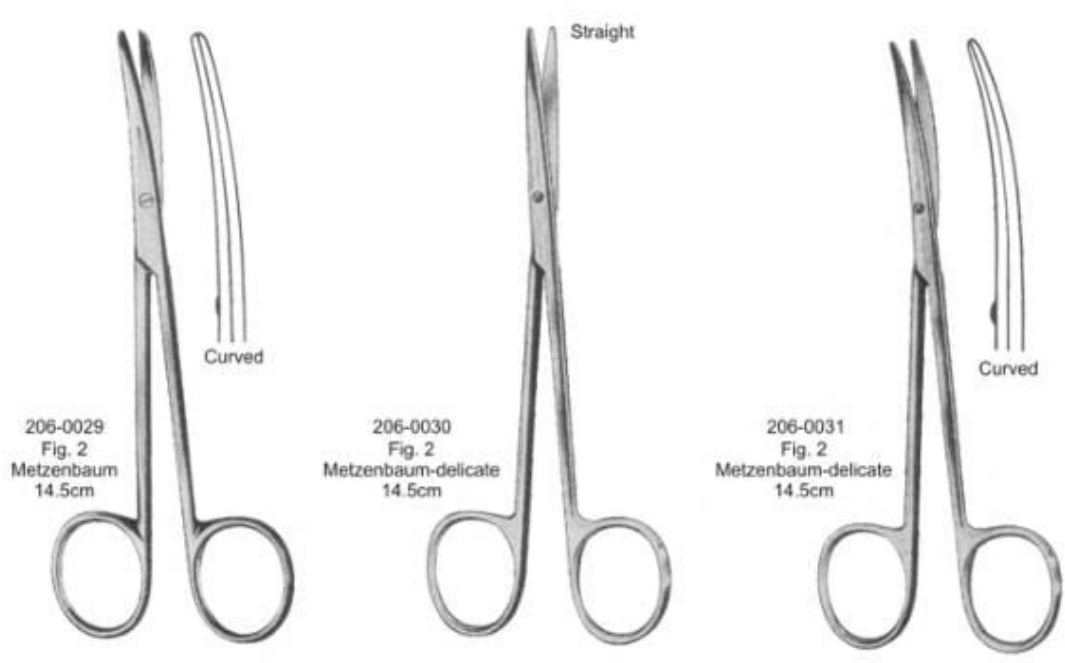
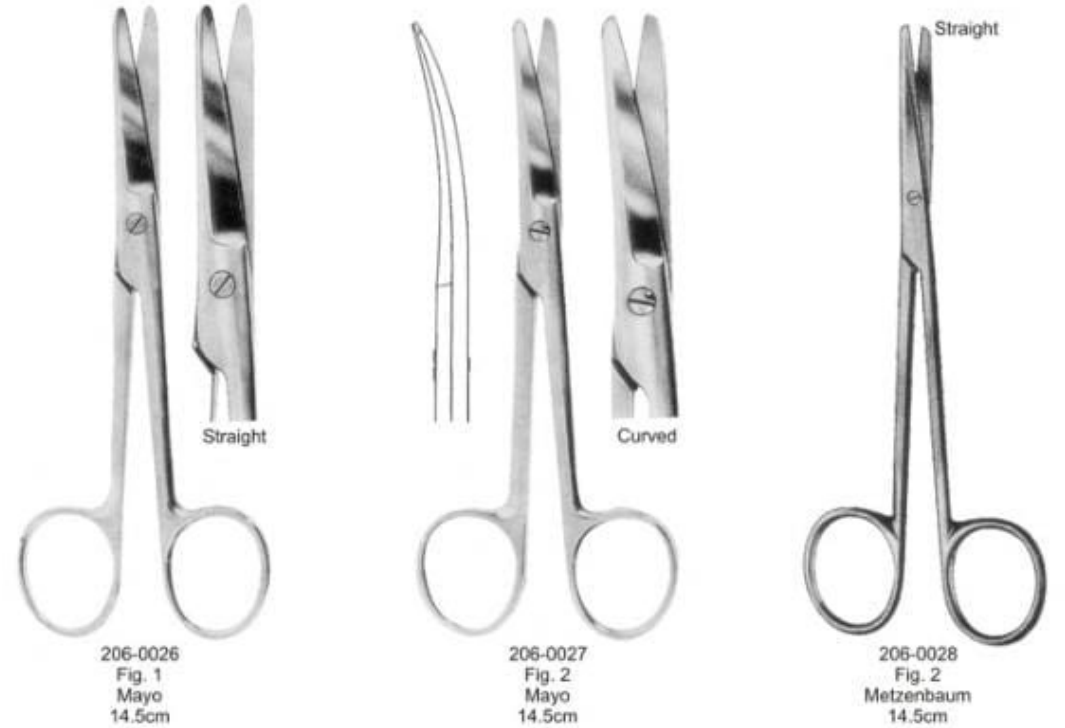
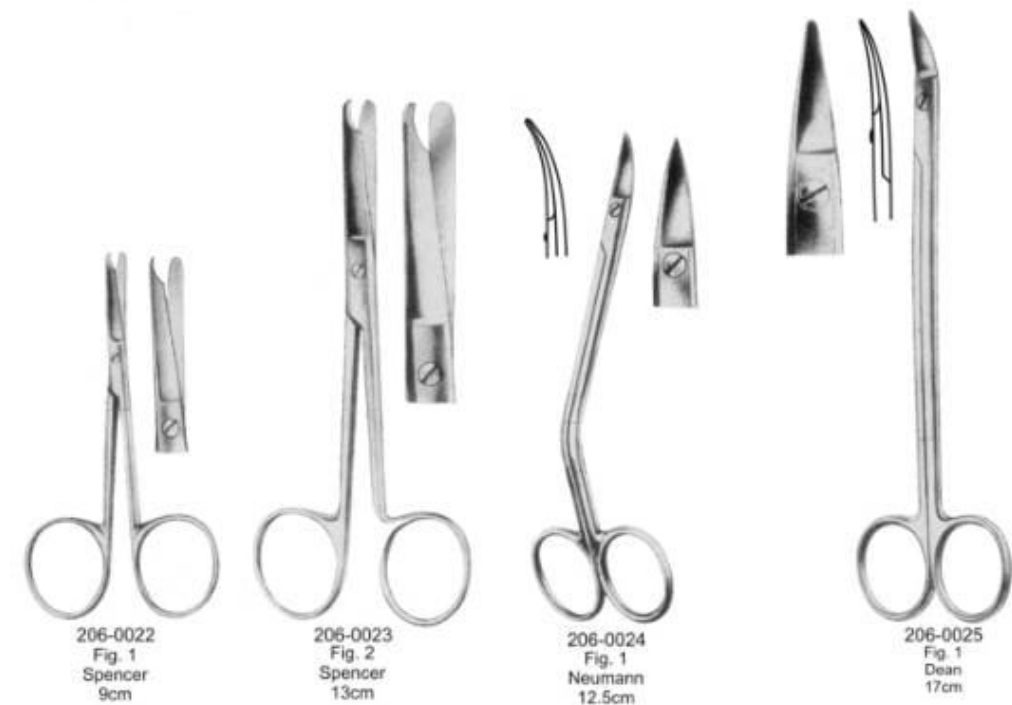
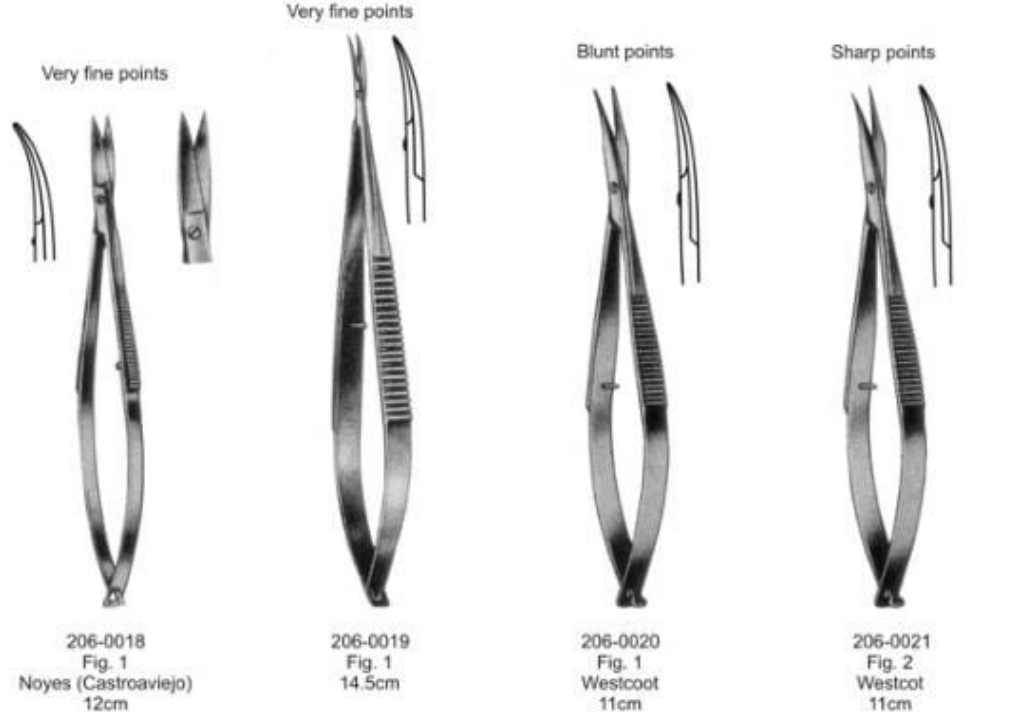



HAEMOSTATIC FORCEPS

surgiprove@gmail.com

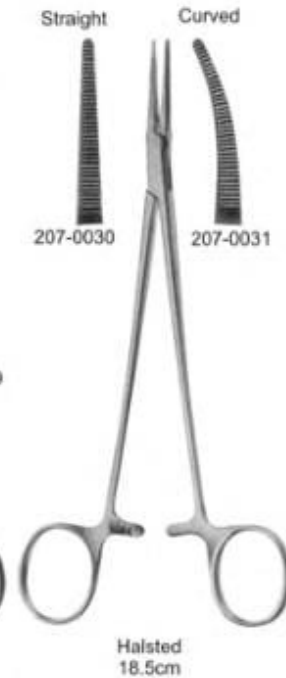
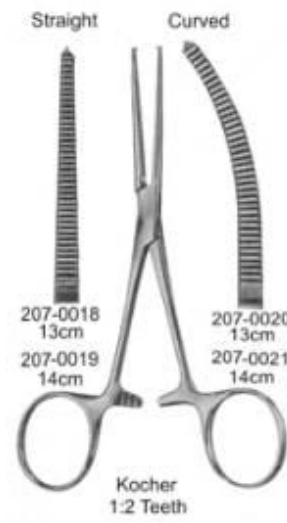
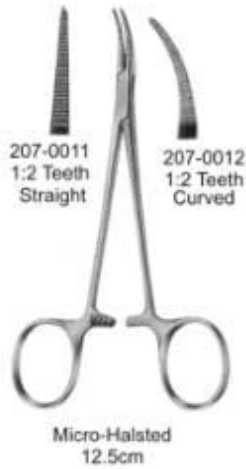
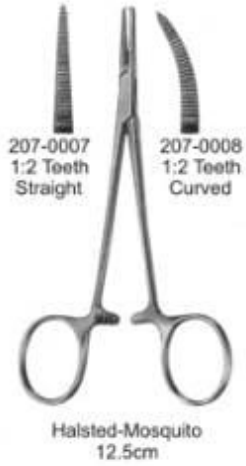

SPONGE AND DRESSING FORCEPS



207-0035
Without Ratchet
14.5cm



207-0036
With Ratchet
14.5cm



207-0037
Curved
17.5cm



207-0038
Curved
21cm

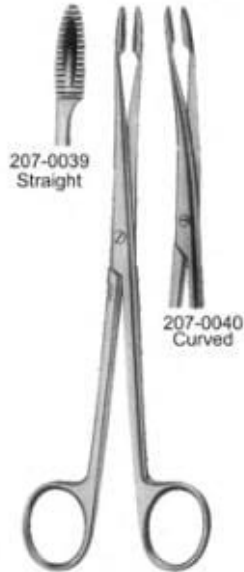

207-0039
Straight

Without Ratchet
18cm

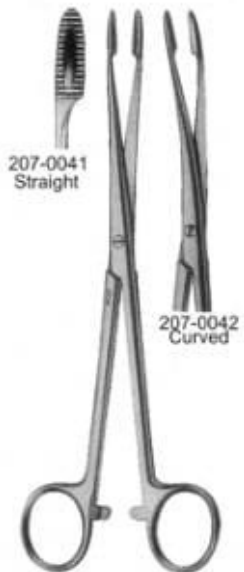

207-0041
Straight

With Ratchet
18cm

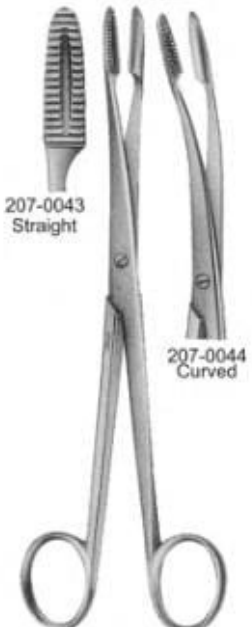

207-0043
Straight

Without Ratchet
20cm

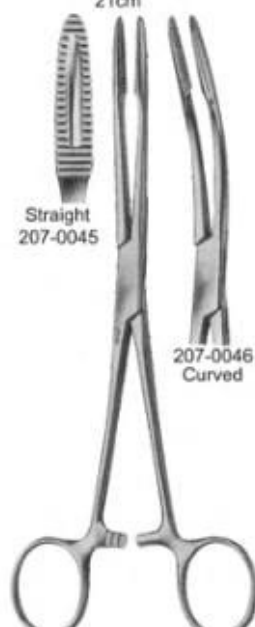

Straight
207-0045

With Ratchet
20cm

207-0040
Curved

207-0042
Curved

207-0044
Curved

207-0046
Curved

TOWEL CLAMPS

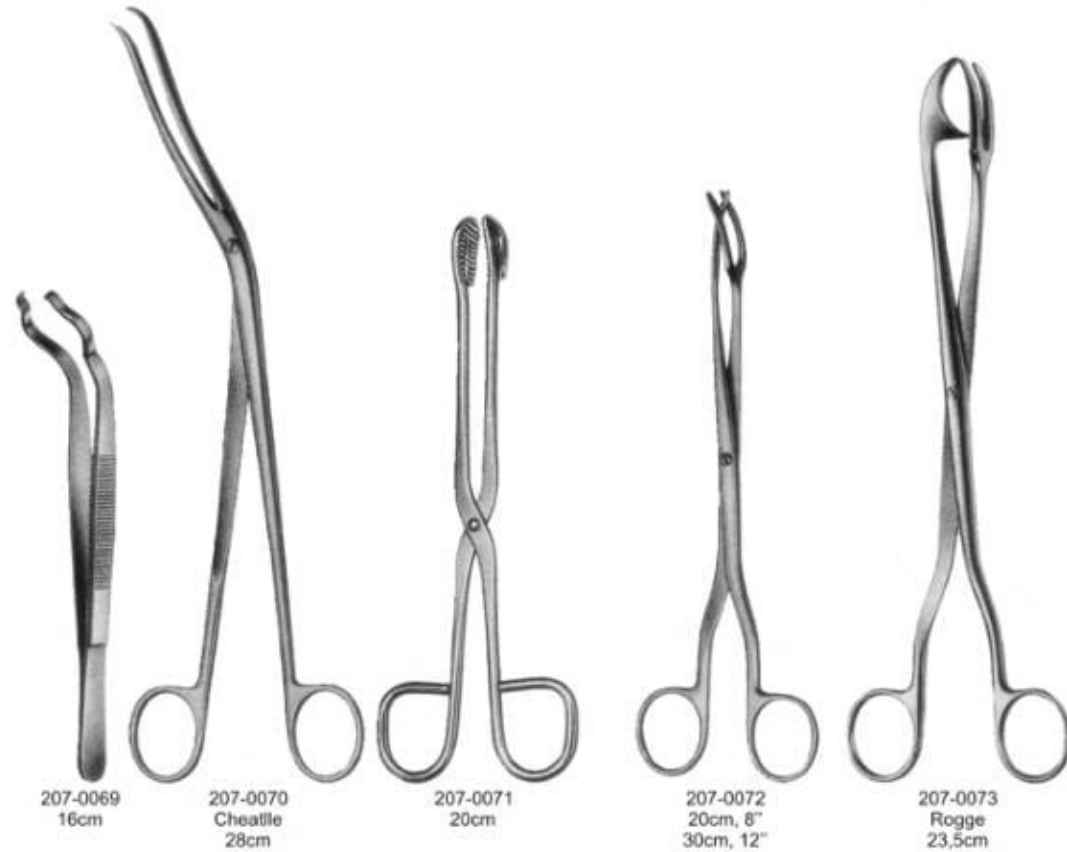
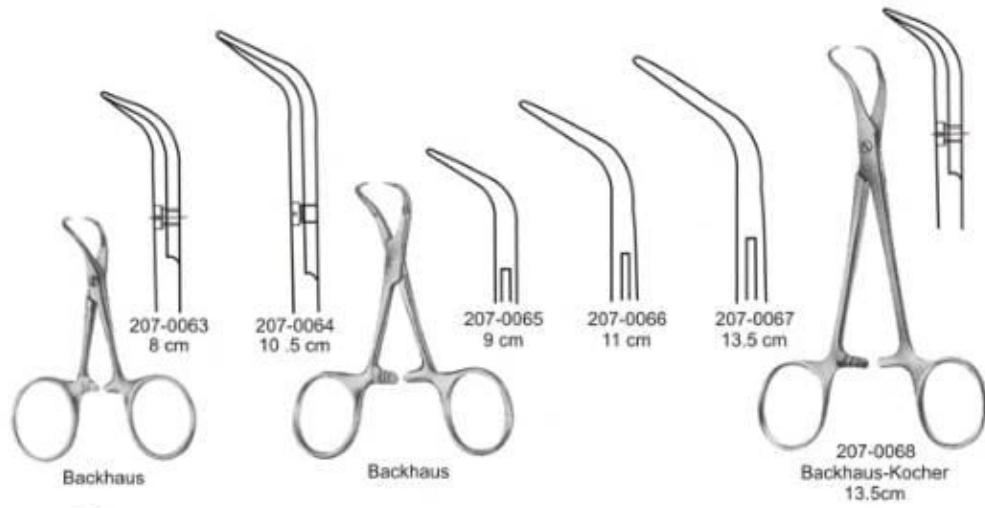



RETRACTORS

surgiprove@gmail.com

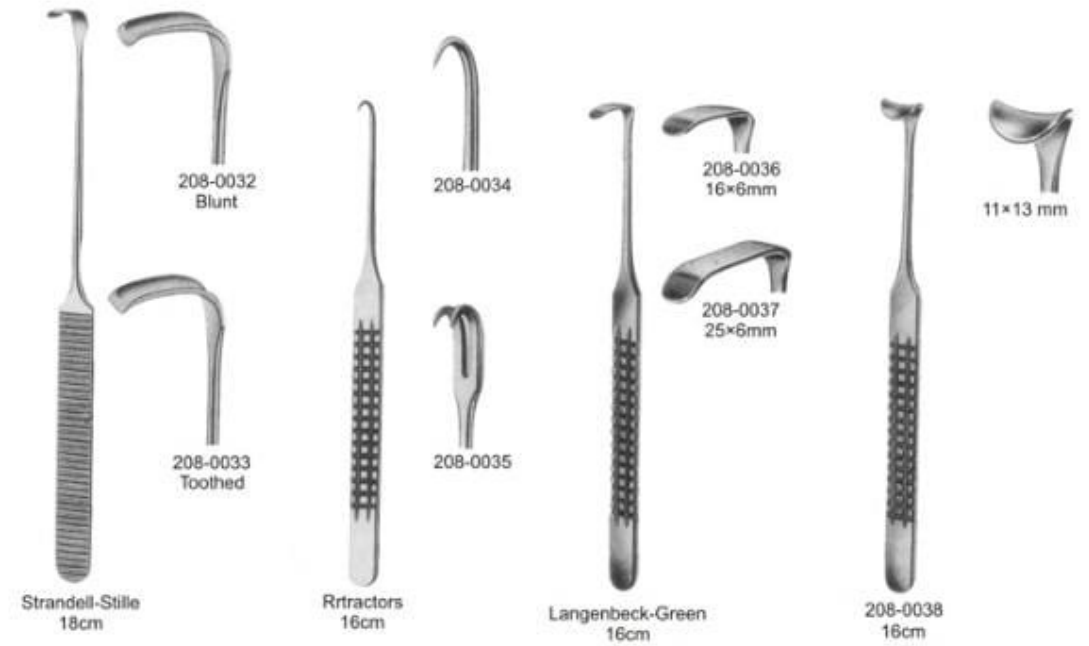
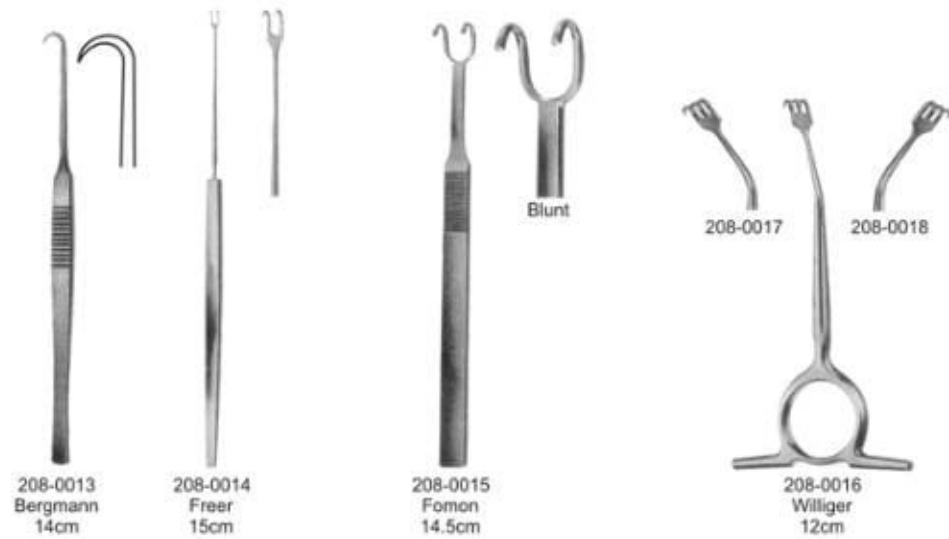
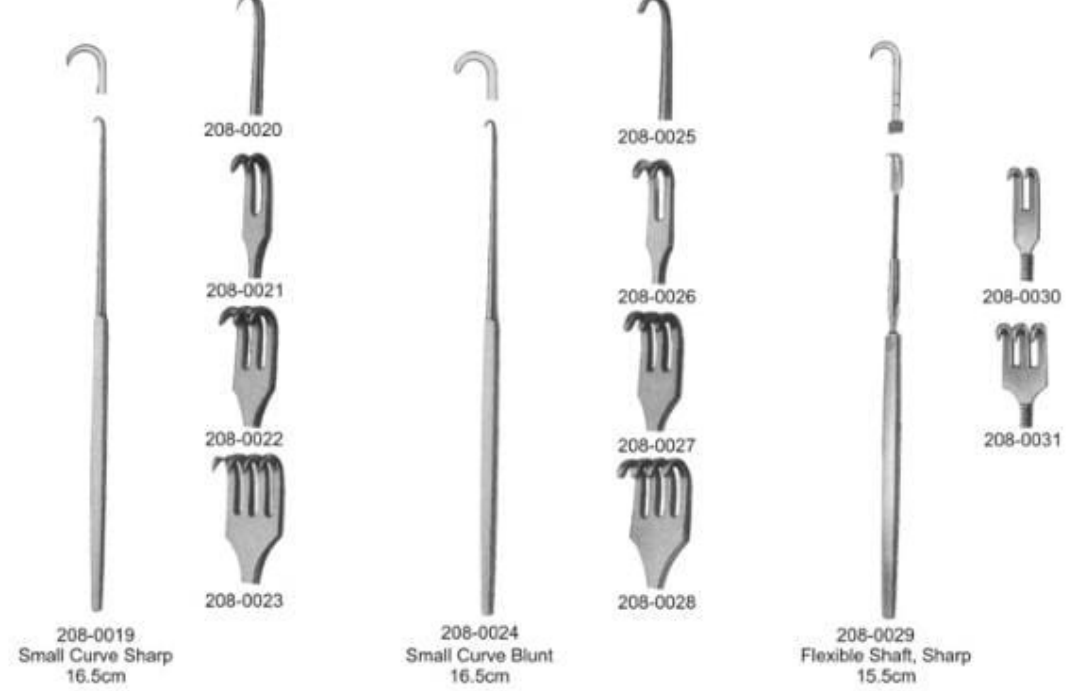
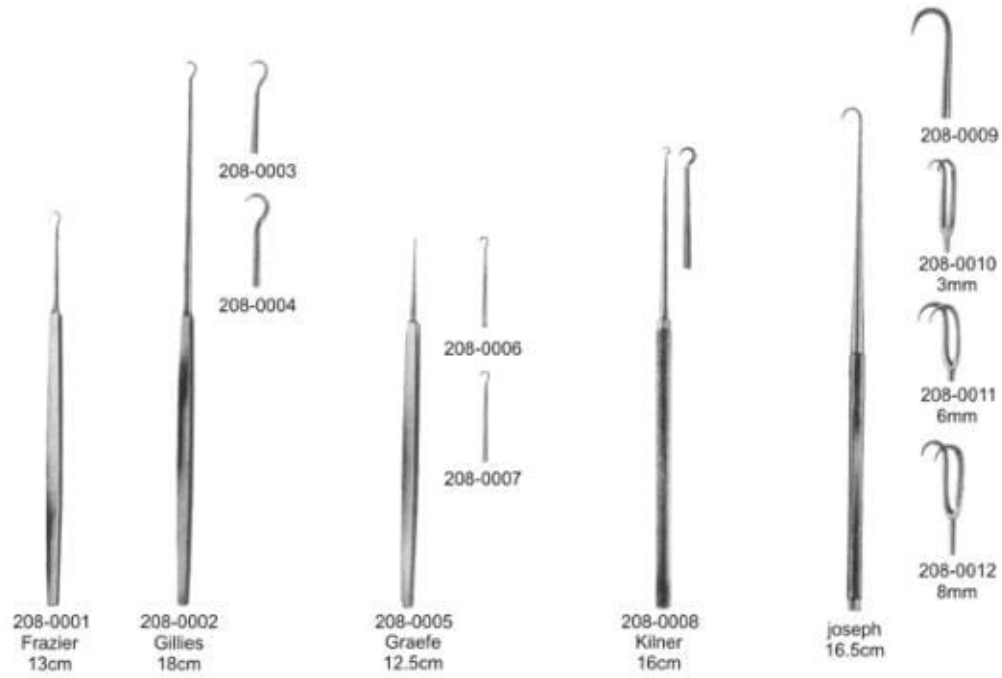



25×10mm
22×10mm
28×12mm
32×12mm
208-0039
Farabeuf (Set of 2Pcs)
12.5cm



23×16mm
20×16mm
24×16mm
28×16mm
208-0040
Farabeuf (Set of 2Pcs)
15cm



208-0041 19×22mm
23×30mm
208-0042 25×26mm
28×38mm
208-0043 28×29mm
33×45mm



Farabeuf (Set of 3Pcs)
16.5cm



208-0044 30×10mm
208-0045 40×10mm
208-0046 43×13mm



Langenbeck
23cm



208-0047 25×6mm
208-0048 35×8mm
208-0049 35×11mm
208-0050 35×15mm
208-0051 41×11mm
208-0052 55×11mm



Kocher-Langenbeck
21.5cm



Langenbeck
21cm

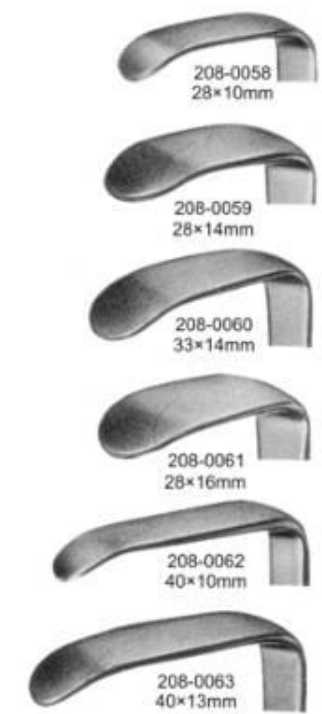

208-0058 28×10mm
208-0059 28×14mm
208-0060 33×14mm
208-0061 28×16mm
208-0062 40×10mm
208-0063 40×13mm



208-0064
Kocher
21cm



208-0065 Alm (Sharp)
7cm
208-0066 Blunt
208-0067 Alm (Sharp)
10cm



Middeldorpf



208-0053 15×15mm
22cm
208-0054 20×22mm
21.5cm
208-0055 28×28mm
23.5cm



208-0056
Greene
22.5cm



208-0057
Buchs
20.5cm



A collection of surgical instruments, including forceps, a scalpel, and various connectors, are arranged on a blue textured surface. The instruments are partially obscured by a dark teal overlay.

ELEVATORS

surgiprove@gmail.com

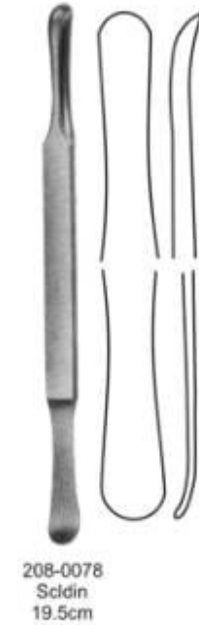
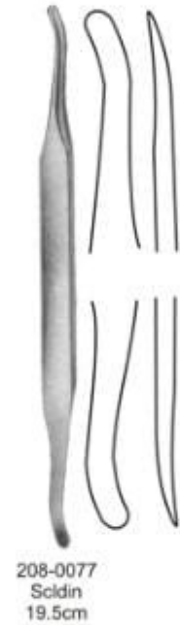
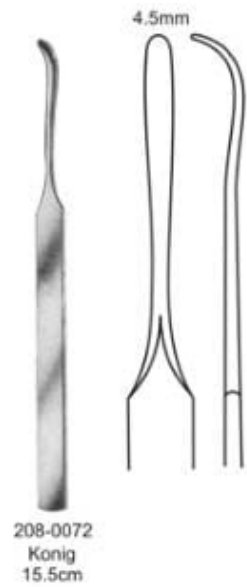
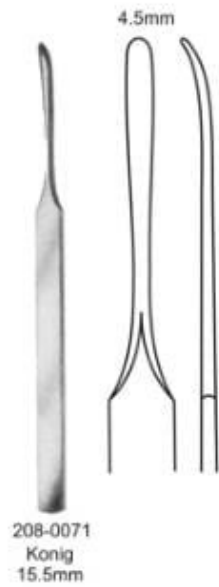
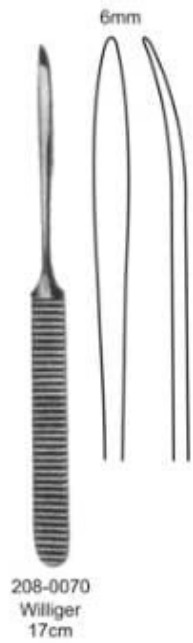
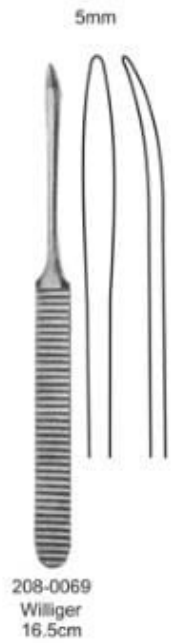



208-0089 (3m)
208-0090 (6mm)
Raspatories
17cm

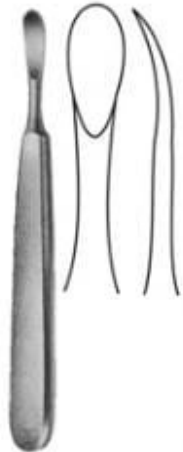

208-0091
8mm
Trelat
14cm

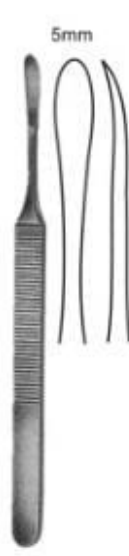

208-0092
König
15.5cm



208-0093
Williger
14cm



208-0094
Williger
16cm

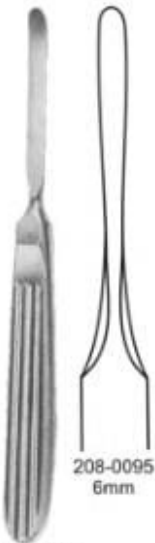

Raspatories
16.5cm



208-0096
8mm

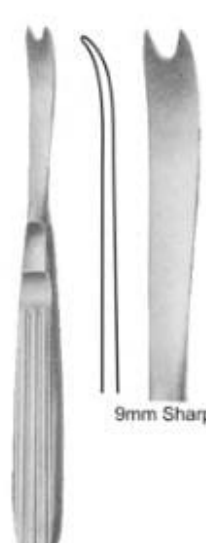

208-0097
Obwegeser
17cm



9mm Sharp



Raspatories
20cm



208-0098
5mm



208-0099
8mm



208-0100
Tessie
22cm

CHISELS & GOUGES

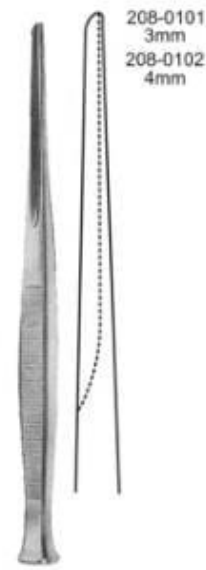

Partsch
17cm

208-0101
3mm
208-0102
4mm



208-0103
Freer
16cm

4mm



208-0104
Freer
16cm

4mm
Curved



Lucas
16cm

208-0105
4mm
208-0106
6mm



Lucas
16cm

208-0107
3mm
208-0108
5mm



Lambotte
12.5cm

208-0109
4mm
208-0110
6mm
208-0111
8mm
208-0112
10mm
208-0113
12mm
208-0114
15mm



14cm

208-0115
4mm
208-0116
6mm
208-0117
8mm



Partsch
14cm

208-0118
3mm
208-0119
4mm
208-0120
5mm
208-0121
6mm

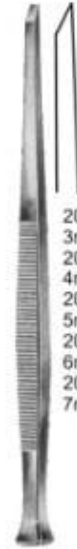

Partsch
17cm

208-0122
3mm
208-0123
4mm
208-0124
5mm
208-0125
6mm
208-0126
7mm



Partsch
14cm

208-0127
3mm
208-0128
4mm

RUBBER DAM INSTRUMENTS

Calmp forceps



209-0001
Ivory light weight
17cm



209-0002
Brewer
17.5cm

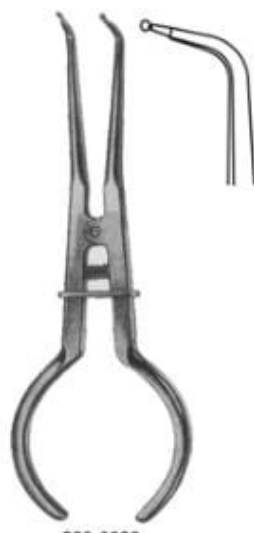

209-0003
Stokes
17.5cm

Punch forceps



209-0004
Ainsworth
17cm



209-0005
Ivory
17cm



209-0006
Rubber dam frame

A pair of surgical pliers is shown against a dark teal background. A magnifying glass is positioned over the jaws of the pliers, highlighting the detail of the instrument. The pliers are oriented horizontally, with the handles on the right and the jaws on the left.

PLIERS

surgiprove@gmail.com

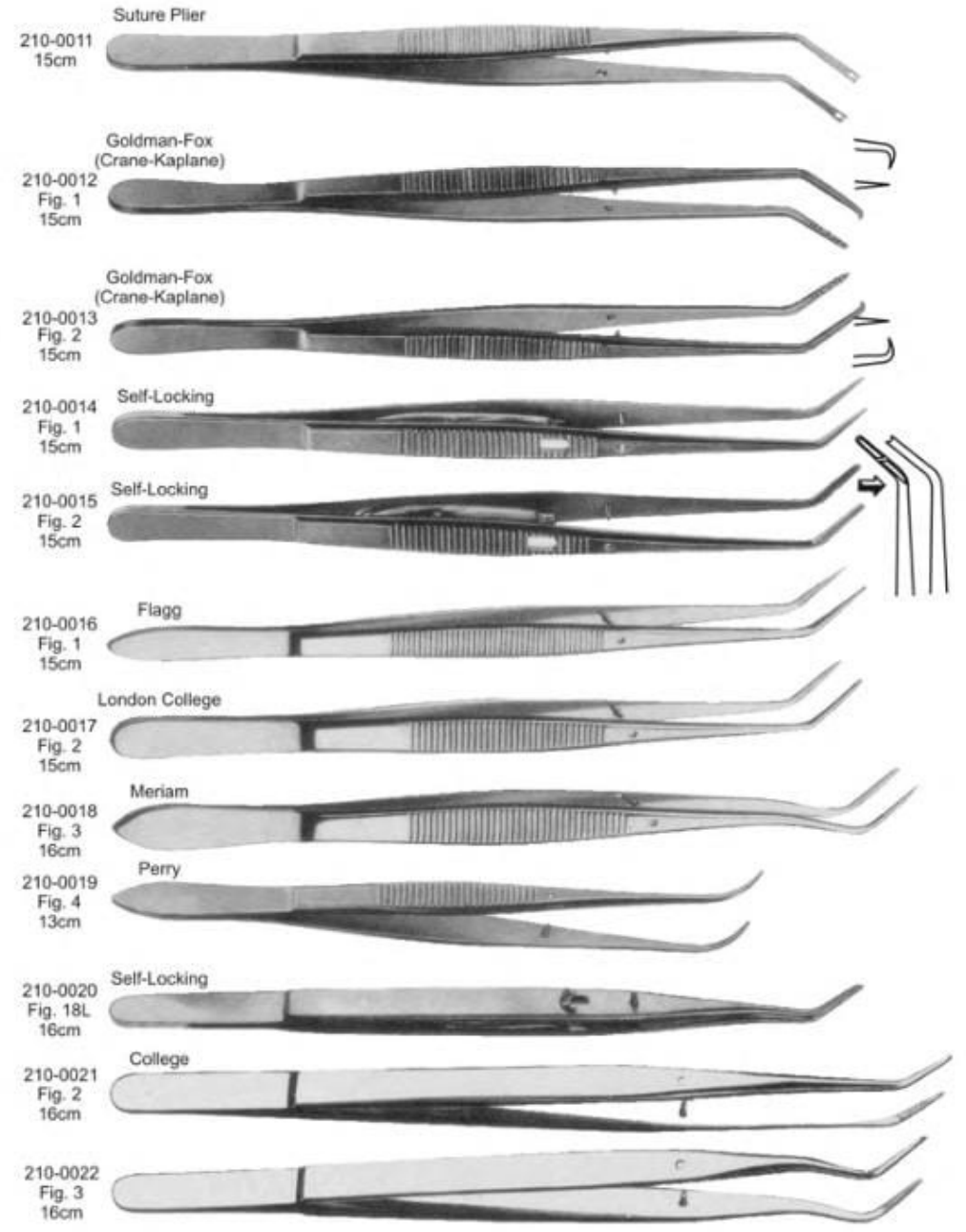
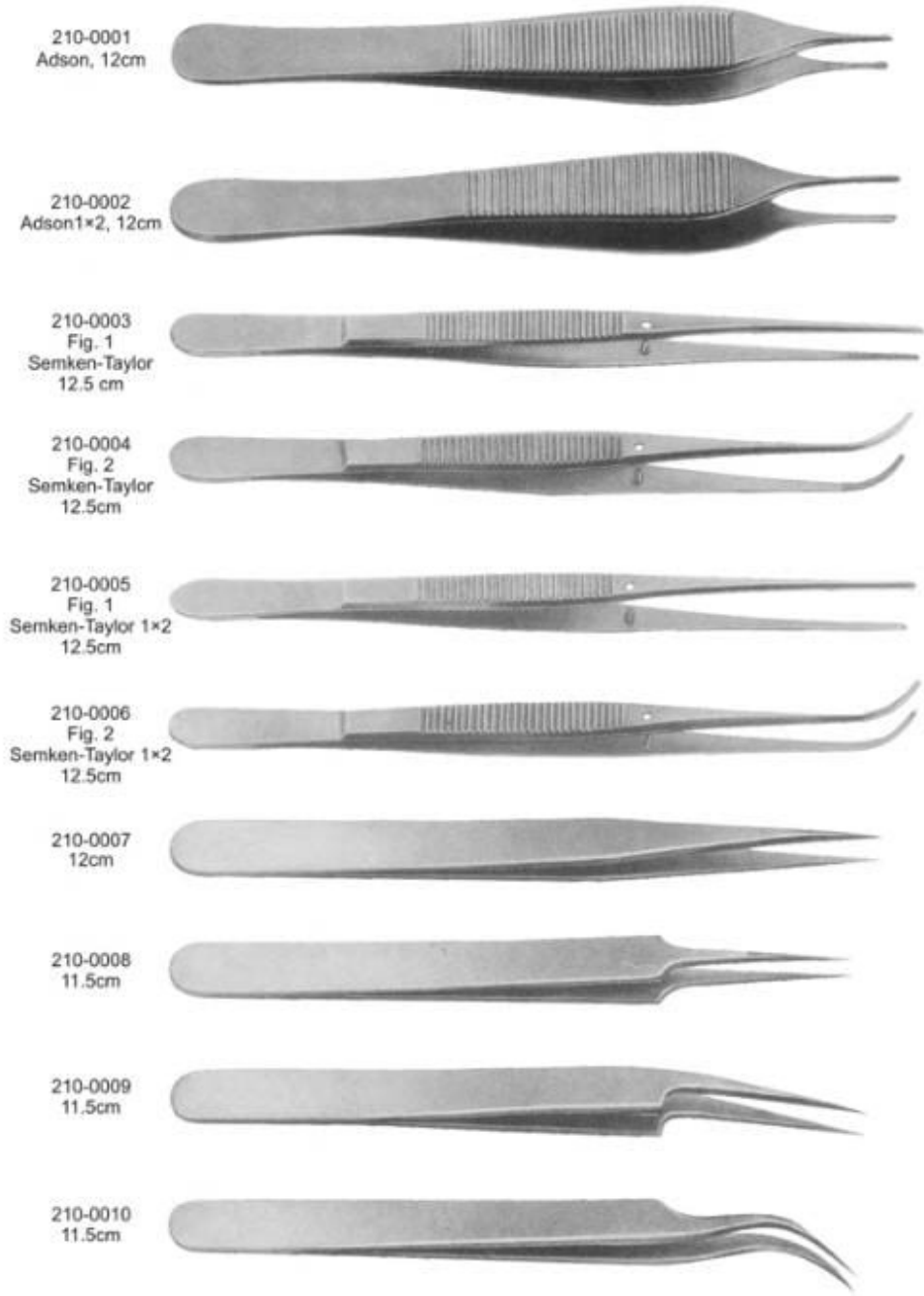



SCALPEL HANDELS

surgiprove@gmail.com



211-0001
No.3L



211-0002
ERGONOMIC
No.7



211-0003
No.7



211-0004



211-0005



211-0006



211-0007
No.4L



211-0008
No.4



211-0009
No.10



211-0010
No.9



211-0011
No. 3



211-0012
BARRON
For "B.P." type blades
for use with No's
10,11,12 & 15 blades
135mm (5.1/4")

HANDELS REFERENCE GUIDE



211-0013
Single ended
Knurling round



211-0014
Double ended
Knurling round



211-0015
Single ended
octangle serrated



211-0016
Double ended
octangle serrated



211-0017
Single ended
hollow round



211-0018
Double ended
hollow round



211-0019
Double ended
hollow round grooved



211-0020
Double ended
swiss pattern octangle

A collection of surgical instruments, including needle holders, forceps, and a scalpel, are arranged on a perforated metal tray. The image is overlaid with a dark teal semi-transparent filter. The text 'NEEDLE HOLDERS' is prominently displayed in the center in a large, white, bold, sans-serif font. Below it, the email address 'surgiprove@gmail.com' is written in a smaller, orange, italicized font within a teal rectangular box.

NEEDLE HOLDERS

surgiprove@gmail.com



212-0001
CASTROVIEJO
145mm (5.3/4")
With catch



212-0002
CASTROVIEJO
145mm (5.3/4")
With catch



212-0003
ARRUGA
135mm (5.1/4")



212-0004
BARRAQUER
120mm (4.3/4")
With catch



212-0005
BARRAQUER
120mm (4.3/4")
Without catch



212-0010
MAYO
190mm (7.1/2")



212-0011
CRILE WOOD
150mm (6")



212-0012
CRILE MURRAY
145mm (5.3/4")



212-0006
CONVERSE
125mm (5")



212-0007
DERF
120mm (4.3/4")



212-0008
MAYO (DUNHILL)
160mm (6.1/4")



212-0009
MAYO
180mm (7")



212-0013
KILNER
135mm (5.1/4")



NAUNTUN MORGAN

212-0014
190mm (7.1/2")
212-0015
250mm (10")



WANGENSTEEN

212-0016
270mm (10.3/4")



212-0017
JAMESON
230mm (9")



212-0018
WRIGHT
125mm (5")



212-0019
GILLIES
Combined needle holder
and scissors
160mm (6.1/4")



212-0020
WARD
Combined needle holder
and scissors
180mm (7")



212-0021
HEANEY
200mm (8")



OLSEN HEGAR
Combined needle holder
and scissors
212-0022 140mm (5.1/2")
212-0023 165mm (6.1/2")
212-0024 190mm (7.1/2")



MAYO



212-0025
MAYO (BAUMGARTNER)
140mm (5.1/2")



212-0026
MAYO (MASSON)
265mm (10.1/2")



212-0027
MAYO
65mm (6.1/2")



212-0028
190mm (7.1/2")



212-0029
200mm (8")



212-0030
230mm (9")



212-0031
HEGAR
200mm (8")



212-0032
HALSEY
125mm (5")



212-0033
MATHIEU
140mm (5.1/2")



212-0034
MATHIEU
170mm (6.3/4")



212-0035
MATHIEU
200mm (8")



212-0036
WEBSTER
Smooth Jaw
115mm (4.1/2")



212-0037
MAYO
150mm (6")



212-0038
MCPHAILS
180mm (7")



LAWRANCE
212-0039 150mm (6")
Lightweight

212-0040 150mm (6")

MOUTH MIRRORS





EXPLORERS

suurgiprove@gmail.com

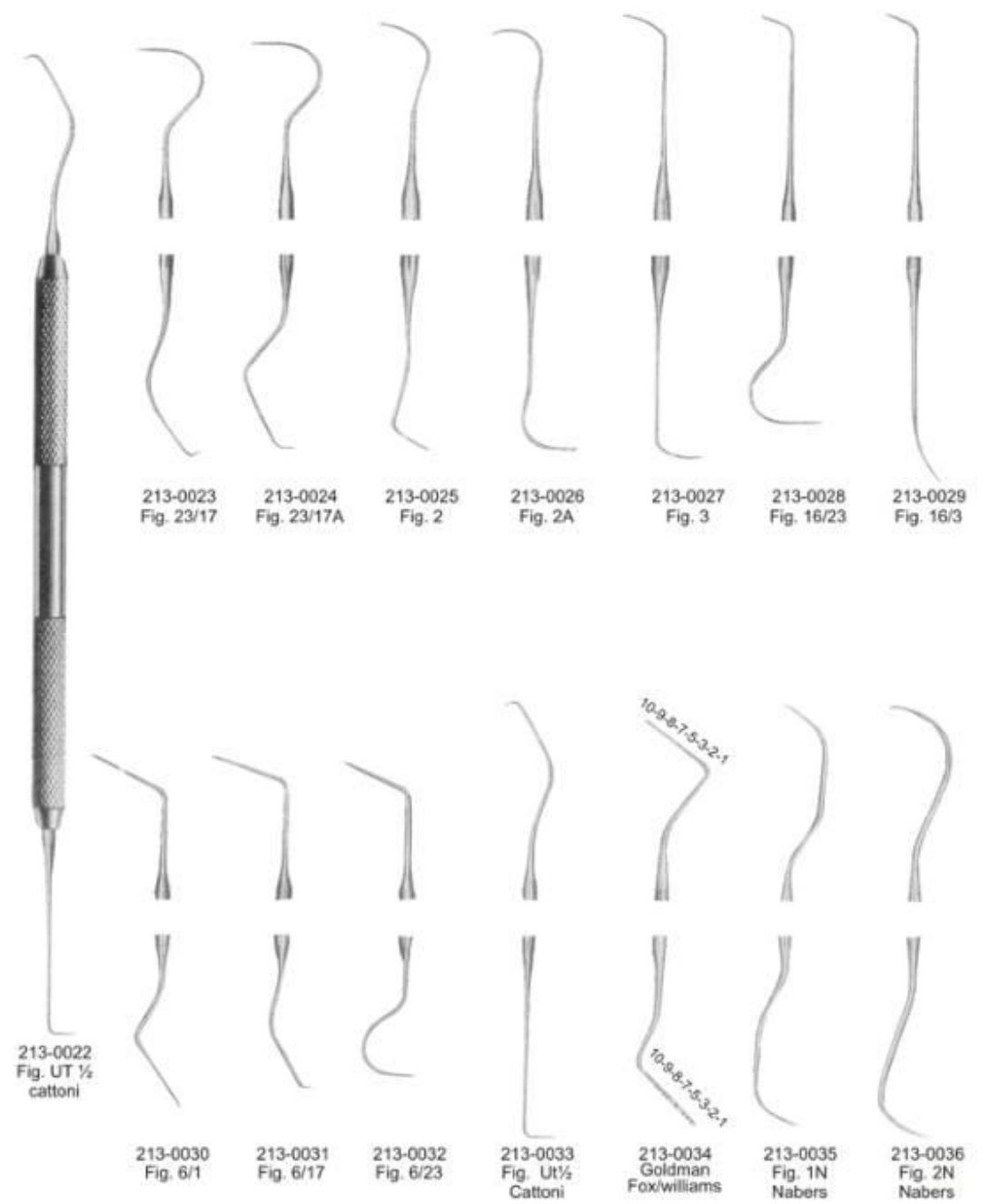
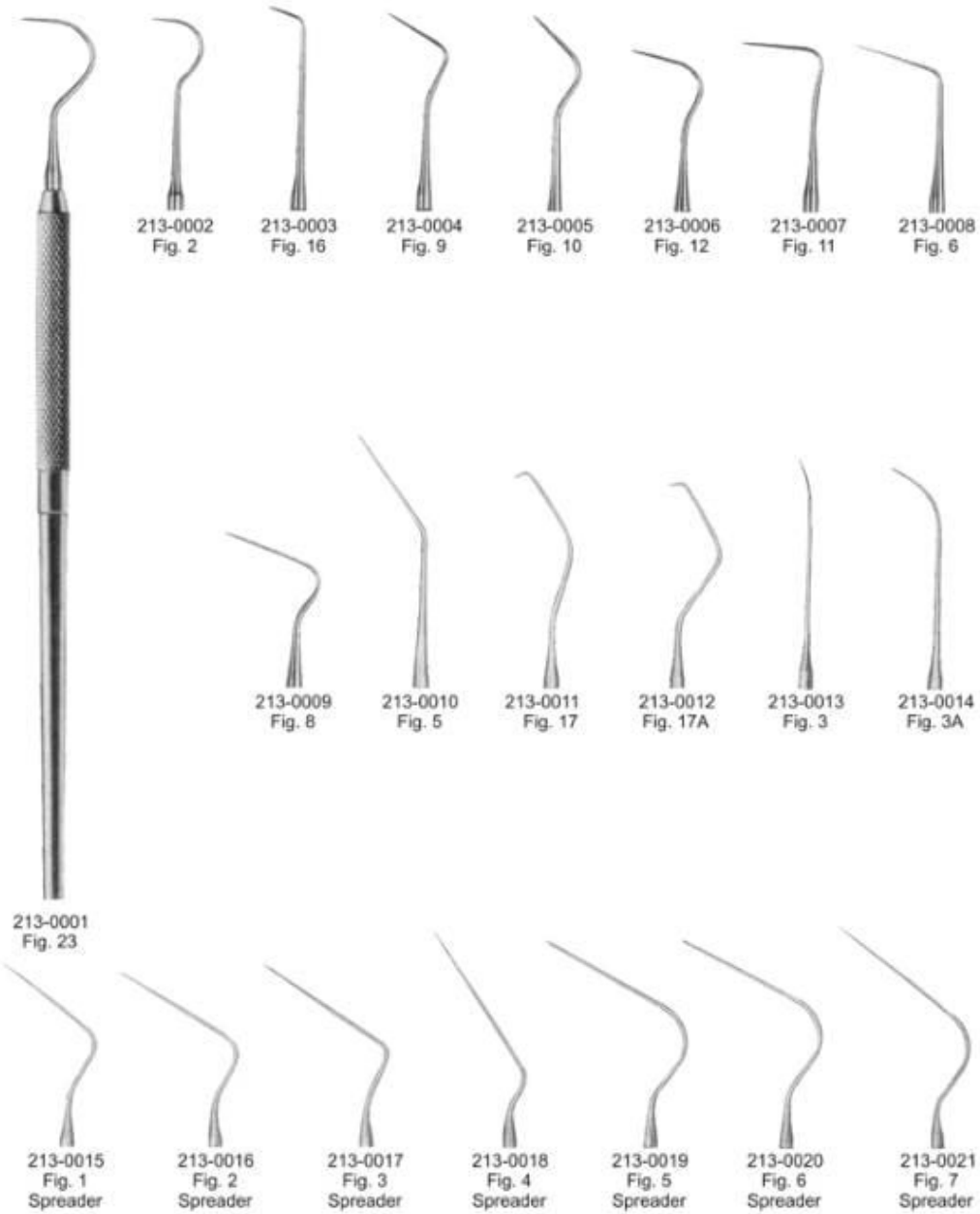

Root canal explorers

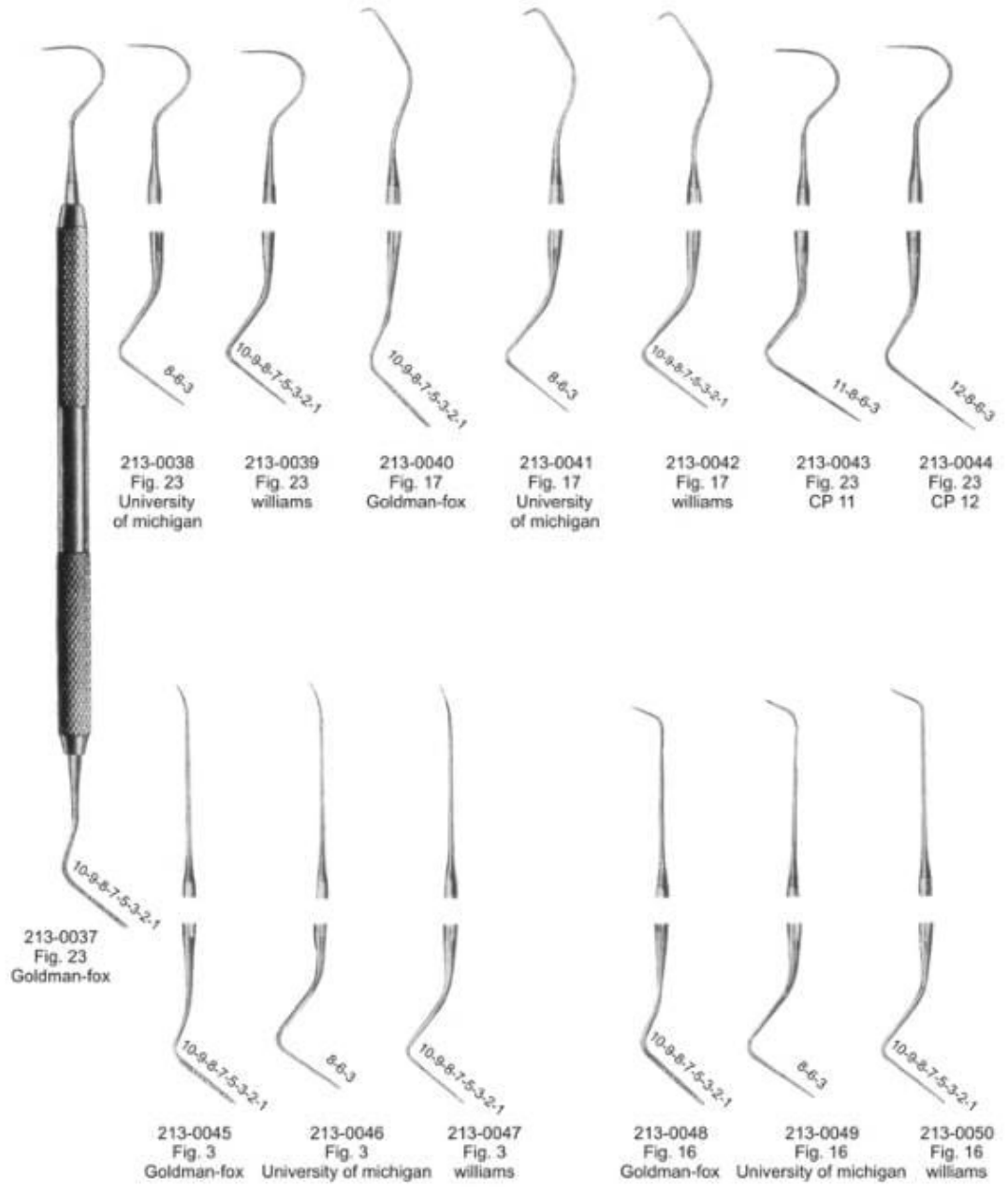

PERIODONTAL POCKET PROBES

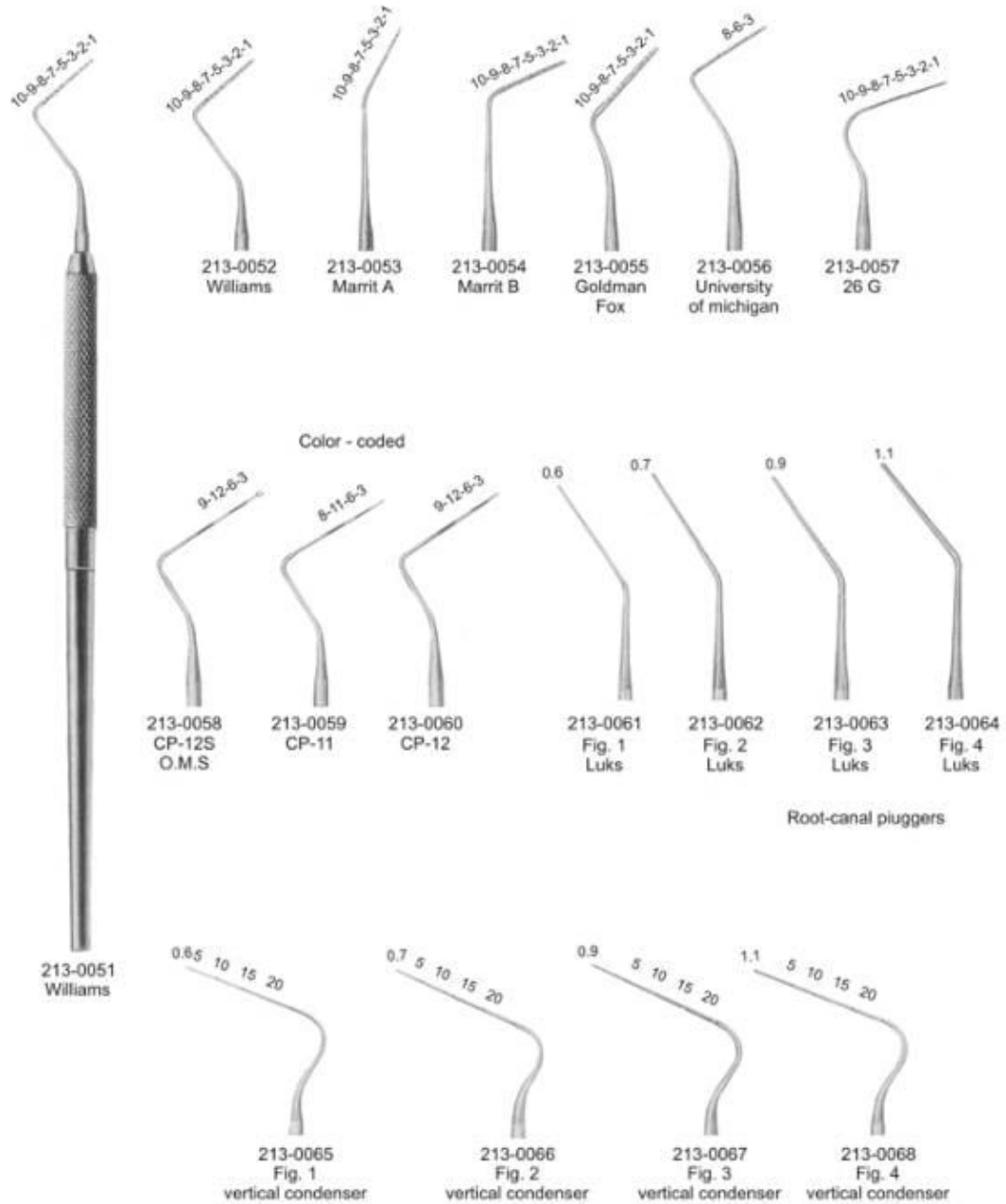



FILLING INSTRUMENTS

surgiprove@gmail.com



213-0069 Fig.1

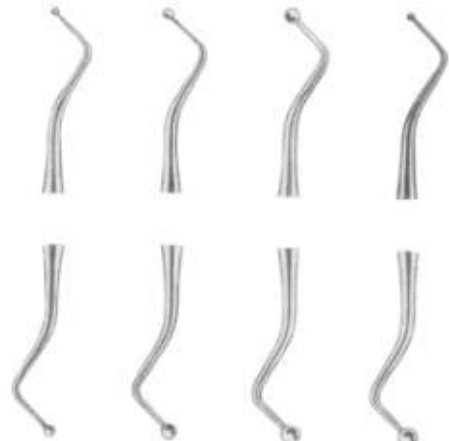

213-0070 Fig.2
213-0071 Fig.3
213-0072 Fig.4
213-0073 Fig.5



213-0074 Fig.1
213-0075 Fig.2
213-0076 Fig.3

Serrated

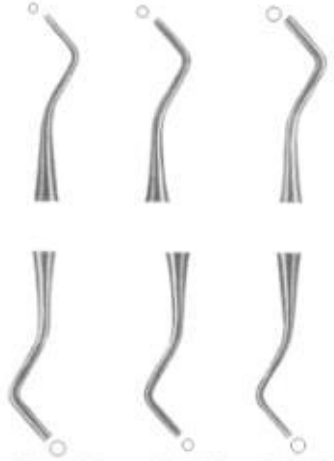

213-0077 Fig.1L
213-0078 Fig.2L
213-0079 Fig.3L

Smooth



213-0080 Fig.1
213-0081 Fig.2
213-0082 Fig.3



213-0083 Fig. 1



213-0084 Fig. 1
213-0085 Fig. 2
213-0086 Fig. 3
213-0087 Fig. 4

Serrated



213-0088 Fig. 1L
213-0089 Fig. 2L
213-0090 Fig. 3L
213-0091 Fig. 4L

Smooth

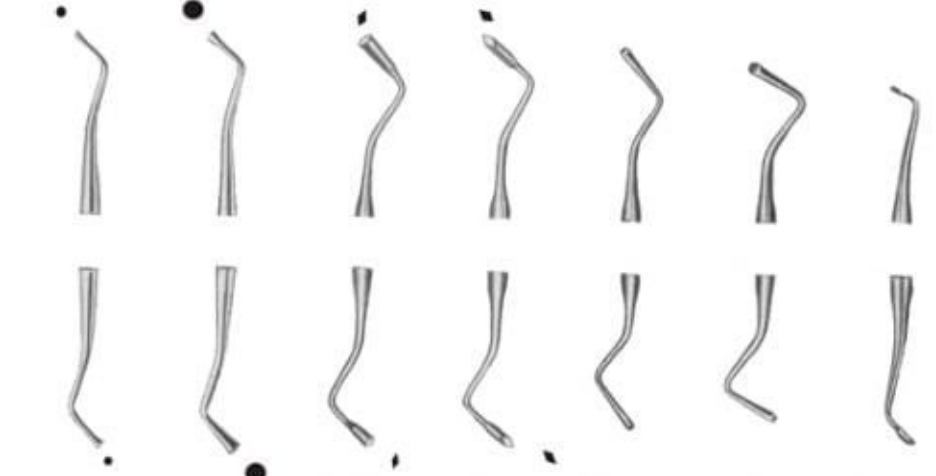

213-0092 Fig. 1 ward
213-0093 Fig. 2 ward
213-0094 Fig.0T Tanner
213-0095 Fig. 1T Tanner
213-0096 Fig. 2T Tanner
213-0097 Fig. 3T Tanner
213-0098 Fig. 01 Marquette

Serrated

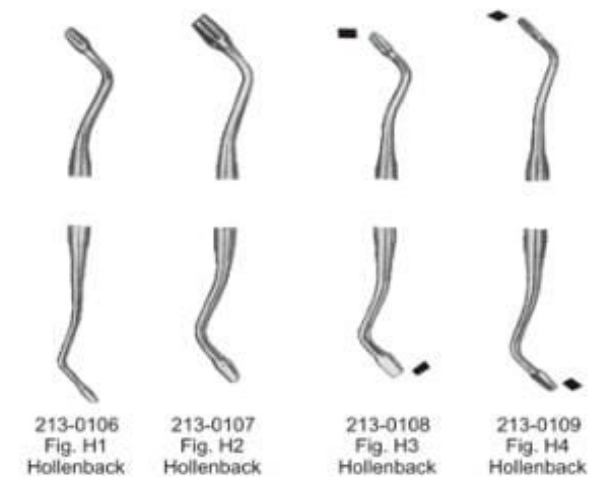
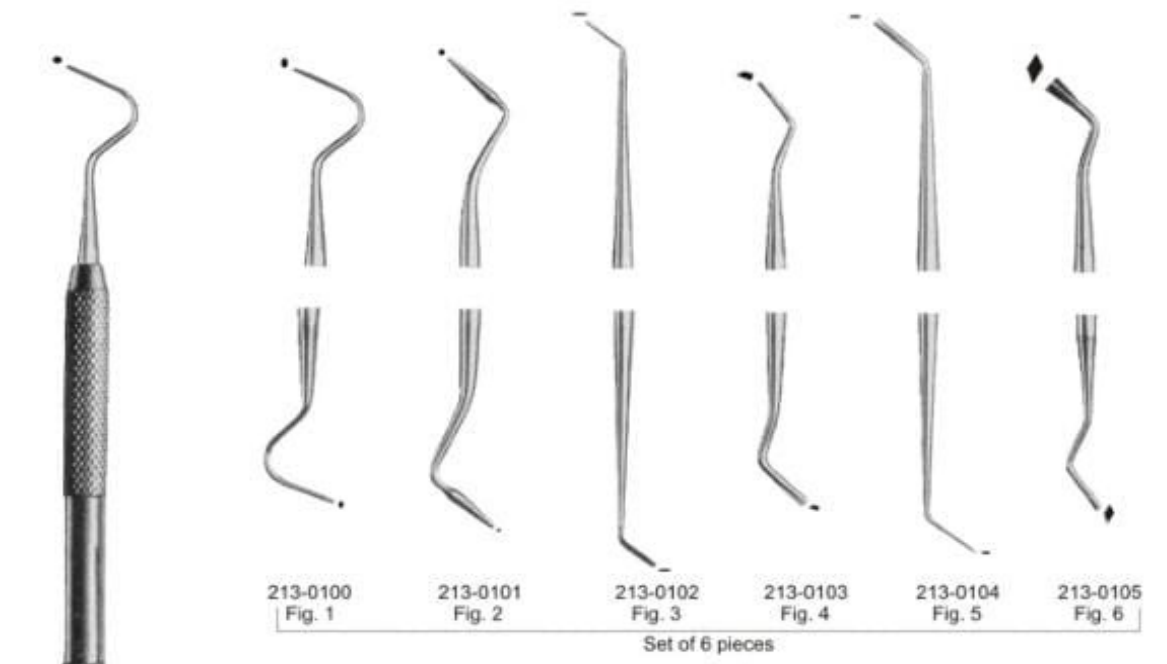
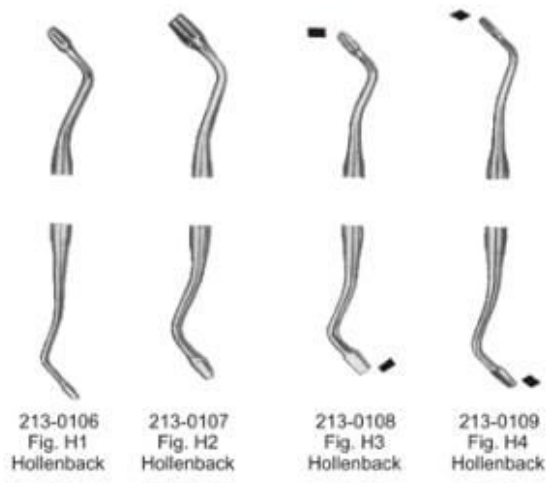
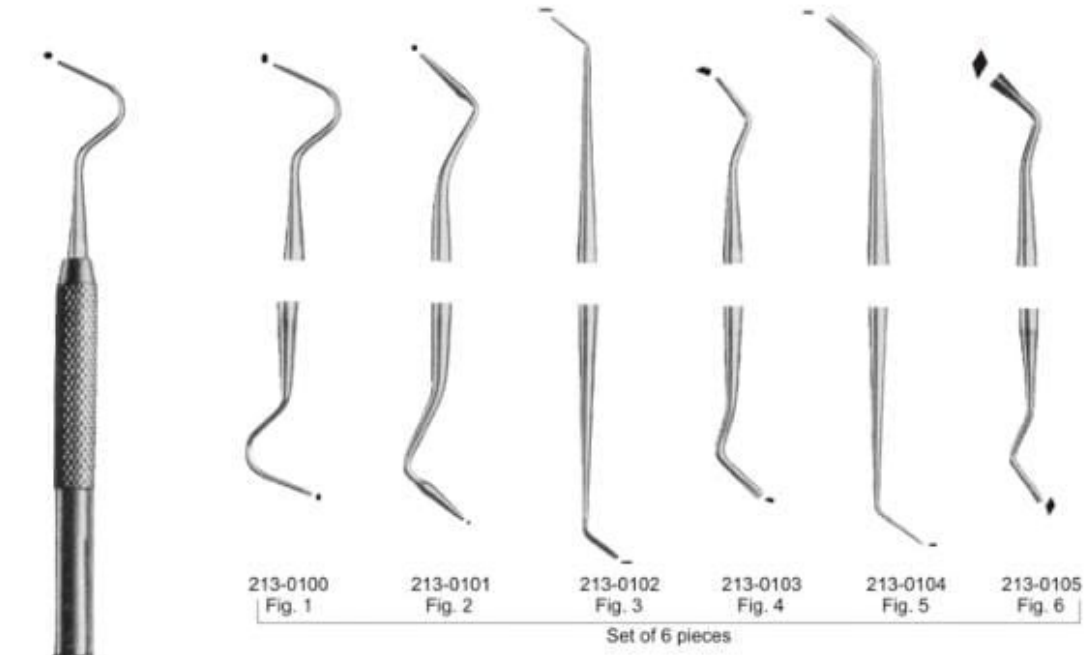

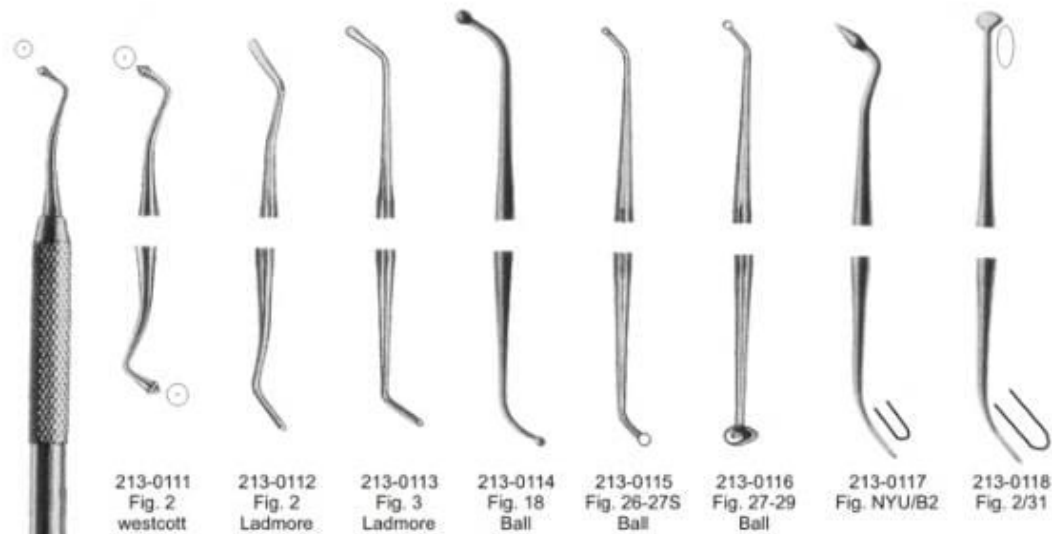

213-0111
Fig. 2
westcott

213-0112
Fig. 2
Ladmore

213-0113
Fig. 3
Ladmore

213-0114
Fig. 18
Ball

213-0115
Fig. 26-27S
Ball

213-0116
Fig. 27-29
Ball

213-0117
Fig. NYU/B2

213-0118
Fig. 2/31

213-0110
Fig. 1
westcott

Plastic Filling Instruments

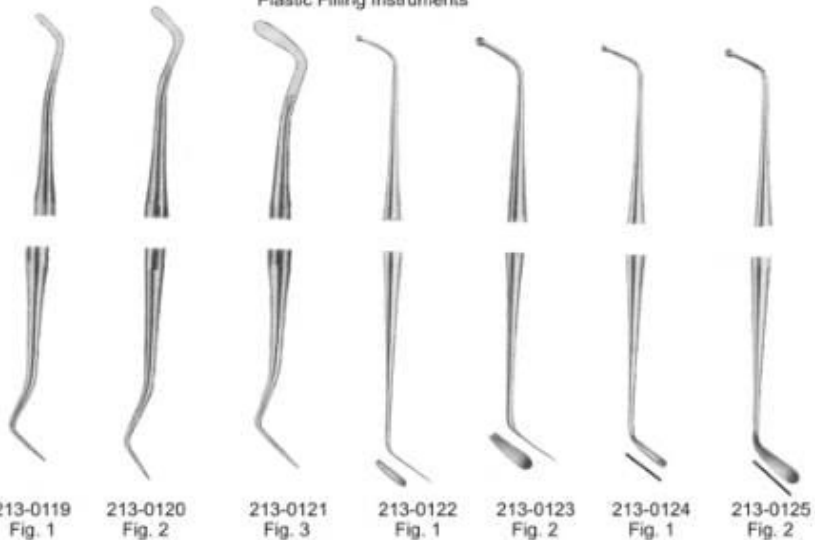

213-0119
Fig. 1

213-0120
Fig. 2

213-0121
Fig. 3

213-0122
Fig. 1

213-0123
Fig. 2

213-0124
Fig. 1

213-0125
Fig. 2

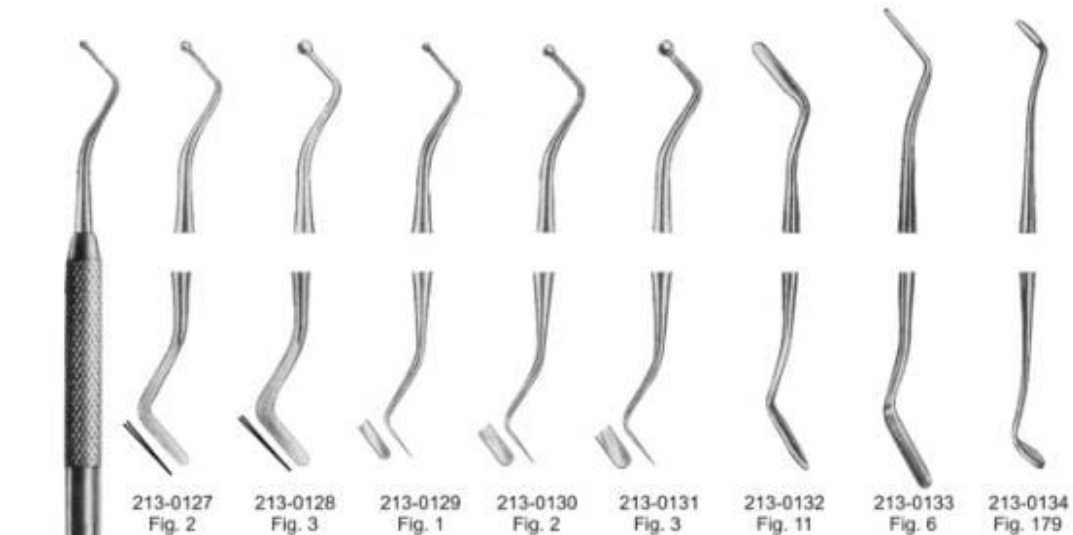

213-0127
Fig. 2

213-0128
Fig. 3

213-0129
Fig. 1

213-0130
Fig. 2

213-0131
Fig. 3

213-0132
Fig. 11

213-0133
Fig. 6

213-0134
Fig. 179

213-0126
Fig. 1

213-0135
Fig. 1
woodson

213-0136
Fig. 2
woodson

213-0137
Fig. 3
woodson

213-0138
Fig. 1
ward

213-0139
Fig. 1S
ward

213-0140
Fig. 2
ward

213-0141
Fig. 1/2
Hollenback

213-0142
Fig. 3
Hollenback

213-0143
Fig. 3S
Hollenback

AMALGAM CARVERS



213-0144
Fig. 1
farhim



213-0145
Fig. 2
USC



213-0146
Fig. 1
interproximal



213-0147
Fig. 2
interproximal
Off-Angle



213-0148
Fig. SHO-A



213-0149
Fig. 3-SHO



213-0150
Fig. 104



213-0151
Fig. 8
wiland



213-0152
Fig. 1

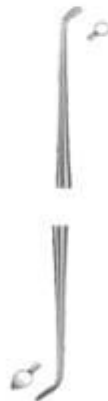

213-0153
Fig. 2



213-0154
Fig. 3



213-0155
Fig. 4



213-0156



213-0157



213-0158

CAVITY PREPRATION INSTRUMENTS

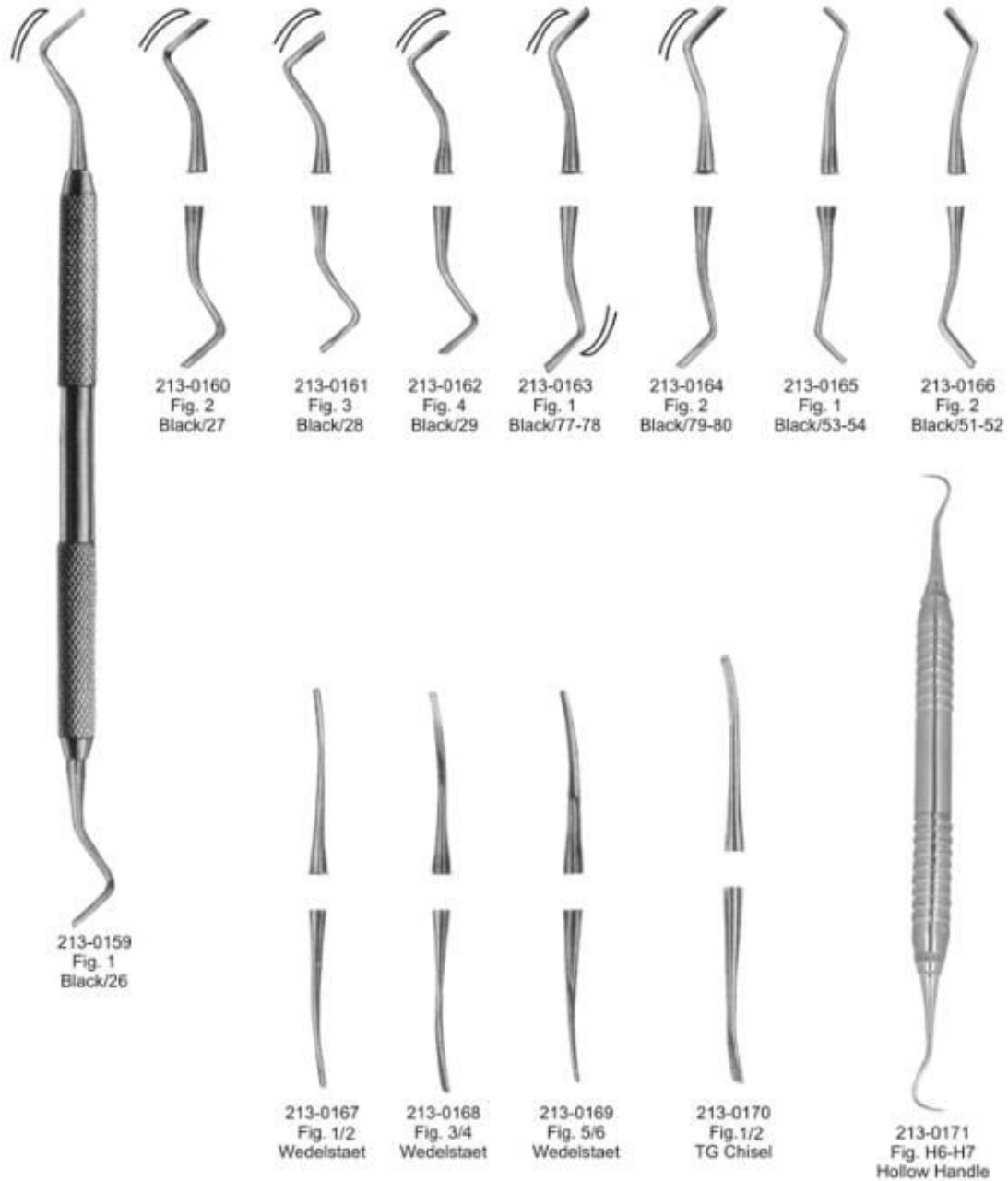

EXCAVATORS

surgiprove@gmail.com



213-0172
Fig. 6

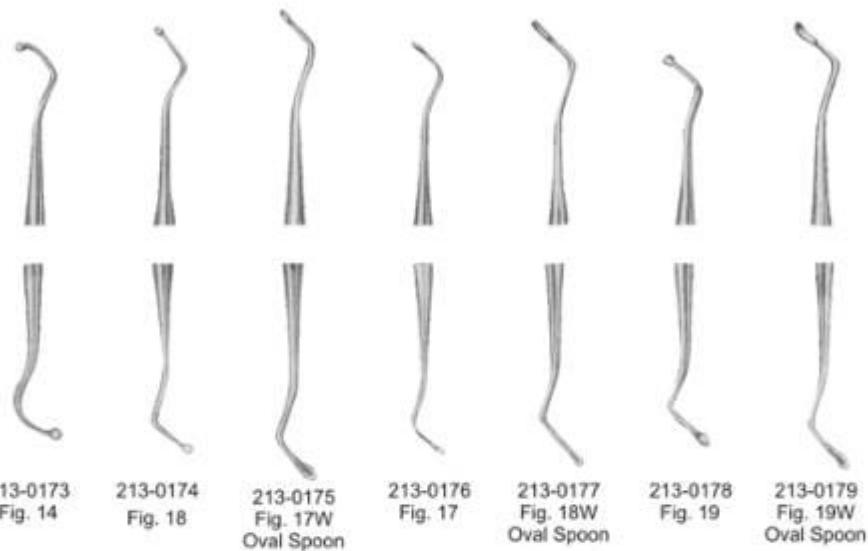

Set of 5 Pieces

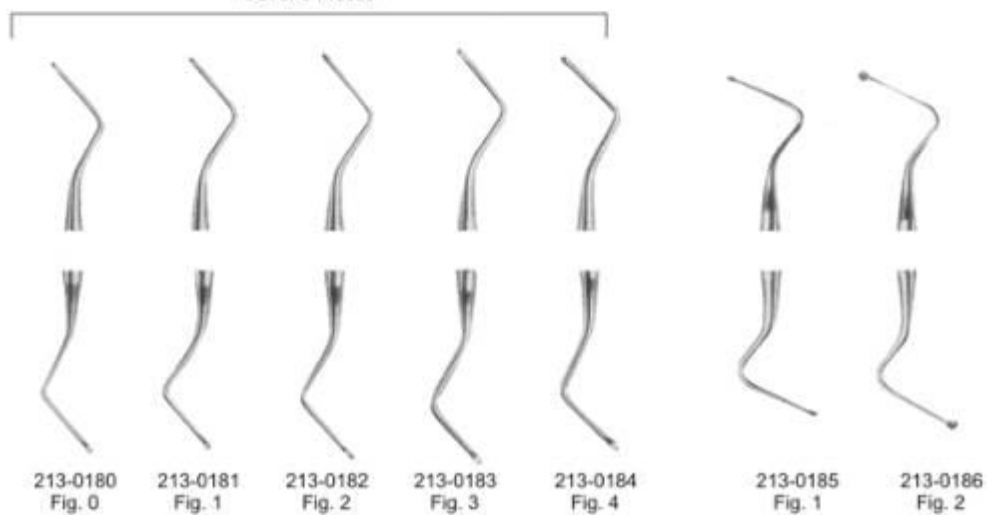

213-0187
Fig. 38/39

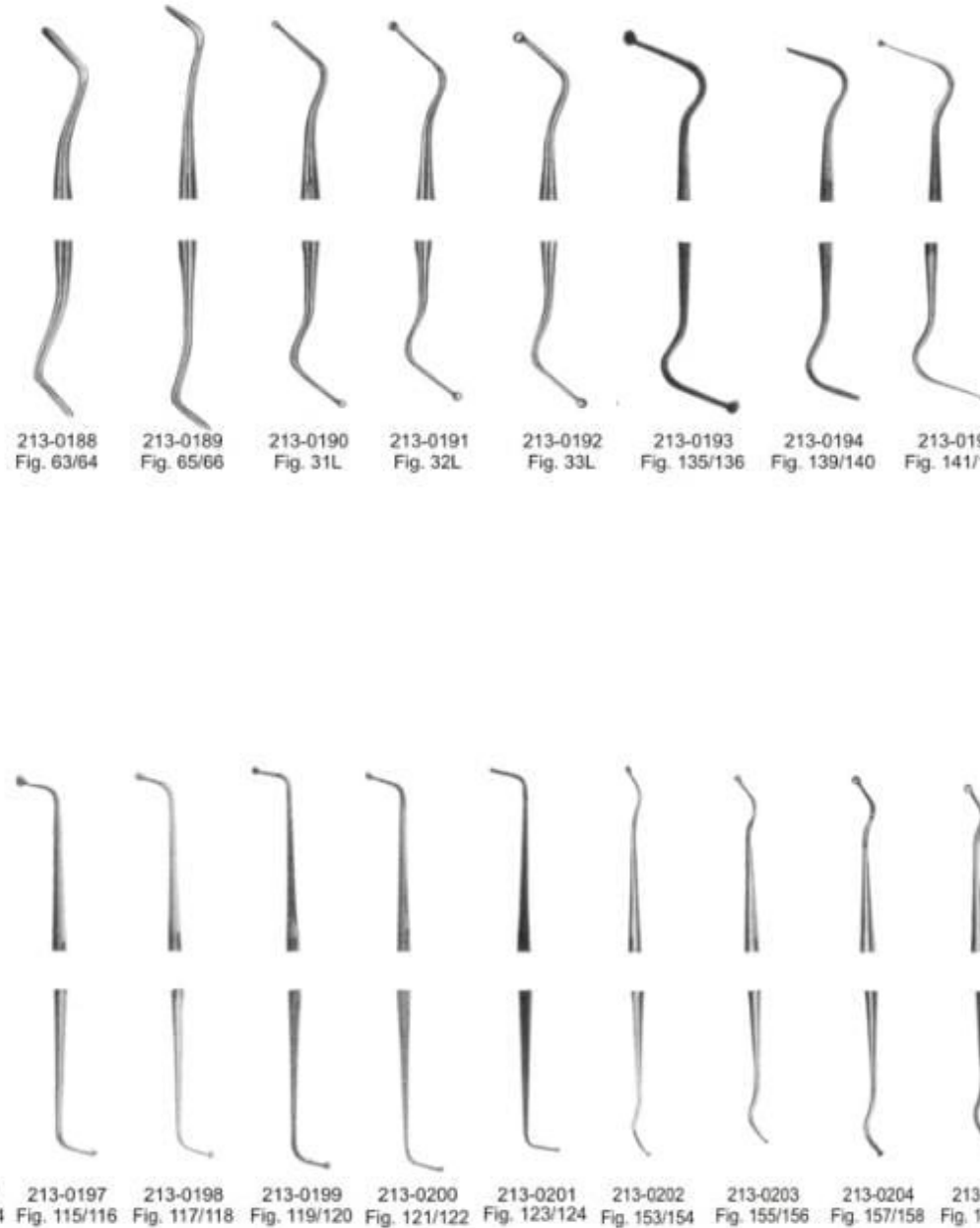

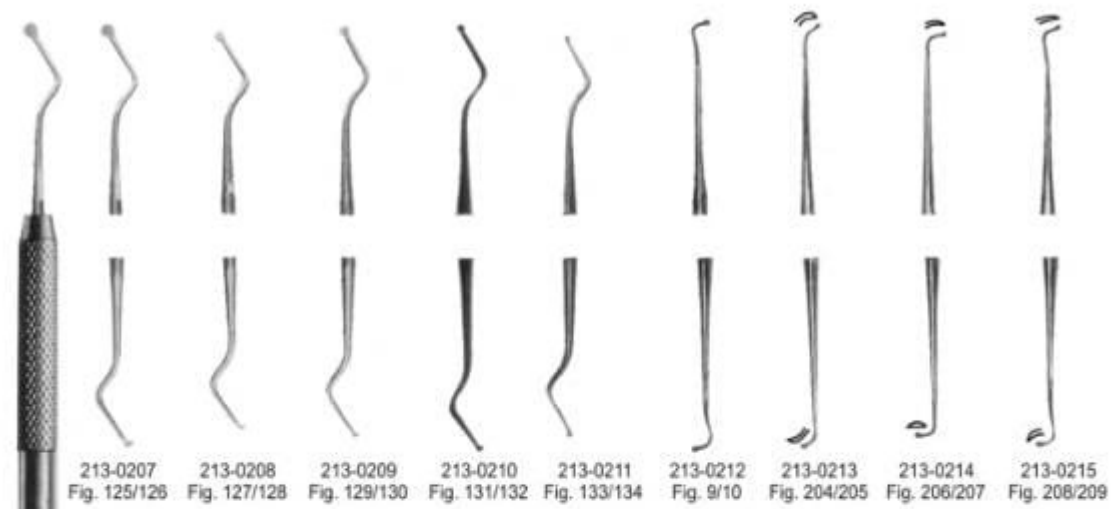

213-0207 Fig. 125/126 213-0208 Fig. 127/128 213-0209 Fig. 129/130 213-0210 Fig. 131/132 213-0211 Fig. 133/134 213-0212 Fig. 9/10 213-0213 Fig. 204/205 213-0214 Fig. 206/207 213-0215 Fig. 208/209

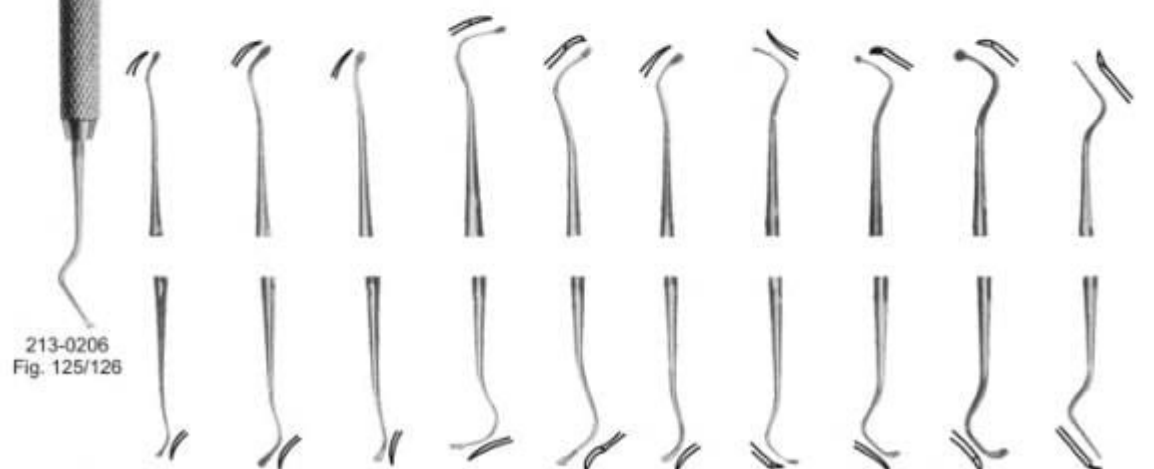

213-0206 Fig. 125/126

213-0216 Fig. 210/211 213-0217 Fig. 212/213 213-0218 Fig. 214/215 213-0219 Fig. 216/217 213-0220 Fig. 218/219 213-0221 Fig. 220/221 213-0222 Fig. 243 213-0223 Fig. 244 213-0224 Fig. 245 213-0225 Fig. 246

PERIODONTAL INSTRUMENTS



213-0226
Fig. M9
Molt



213-0227
Fig. 1
Hopkins



213-0228
Fig. 2
Hopkins



213-0229
Fig. 3
Mead



213-0230
Fig. 3
Prichard



213-0231
Fig. Pr3
Freer



213-0232
Fig. 16
Freer



BONE FILES

surgiprove@gmail.com

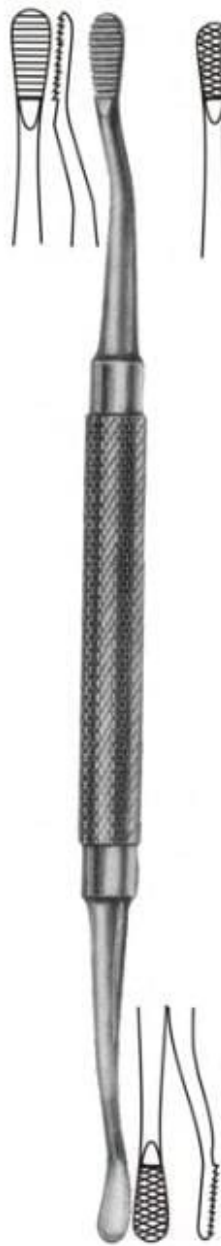

213-0233
Fig. 12 CA



213-0234
Fig. 12A



213-0235
Fig. 12
Howard



213-0236
Fig. 33



213-0237
Fig. 45
Miller



213-0238
Fig. 1
Wahl



213-0239
Fig. 2
Wahl



213-0240
Fig. 1
Polokoff



213-0241
Fig. 64
Miller



213-0242
Fig. 10

BONE CURETTES

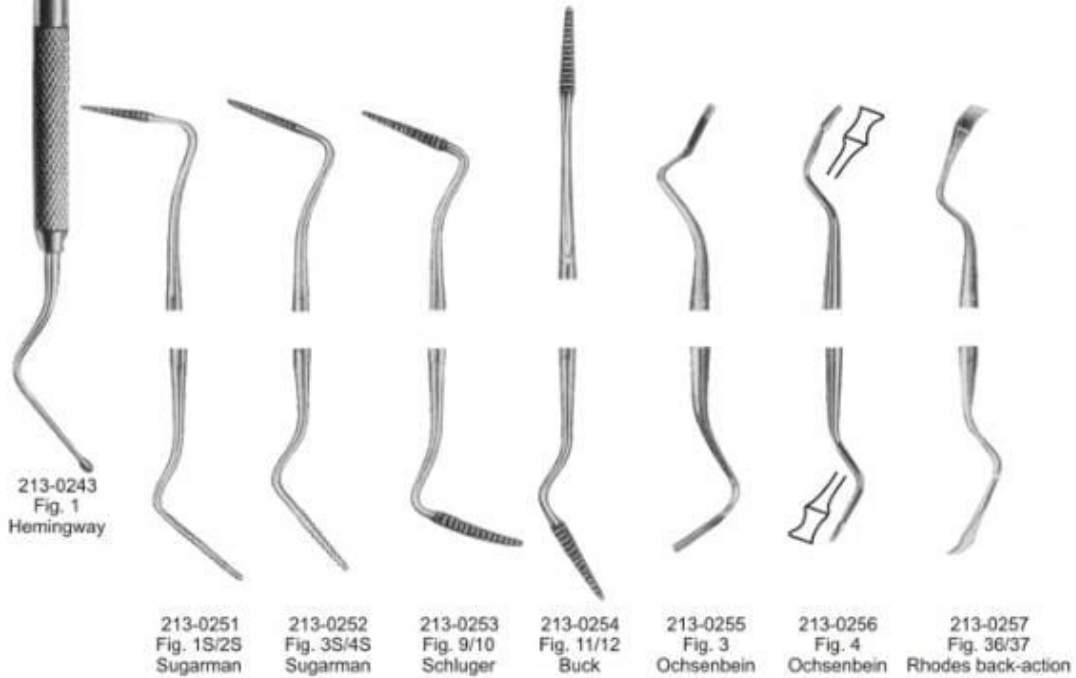
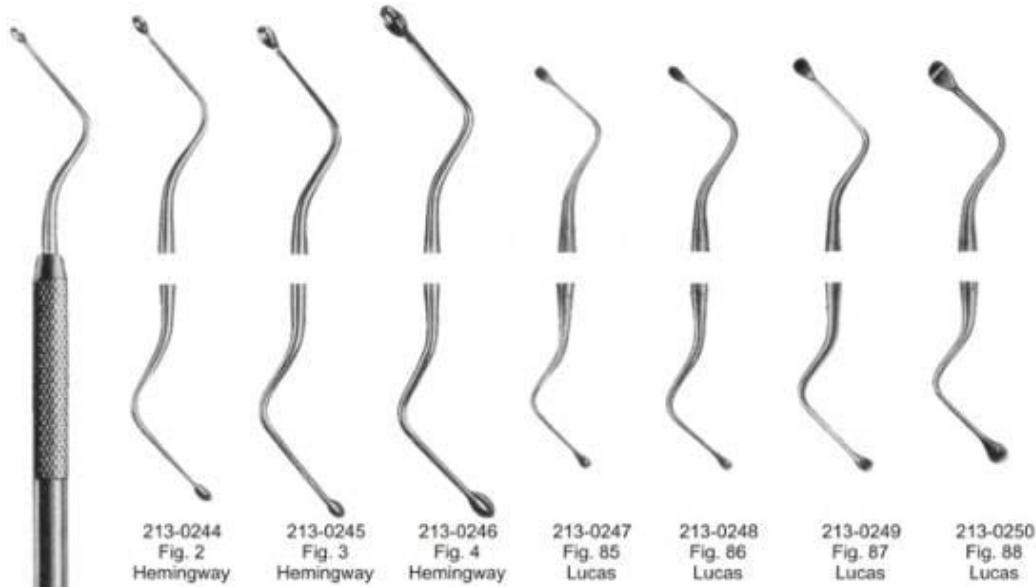



PERIODONTAL INSTRUMENTS

surgiprove@gmail.com

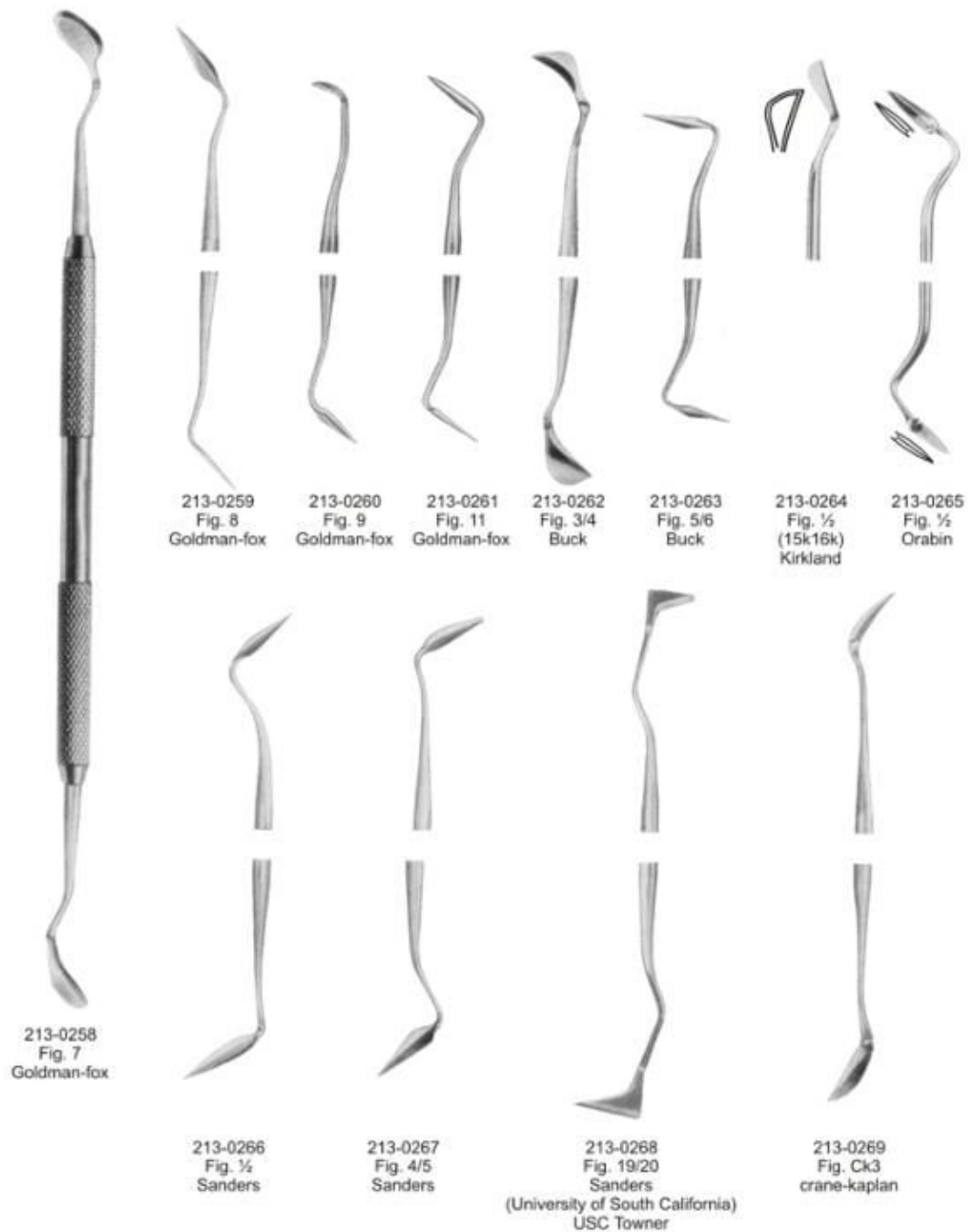
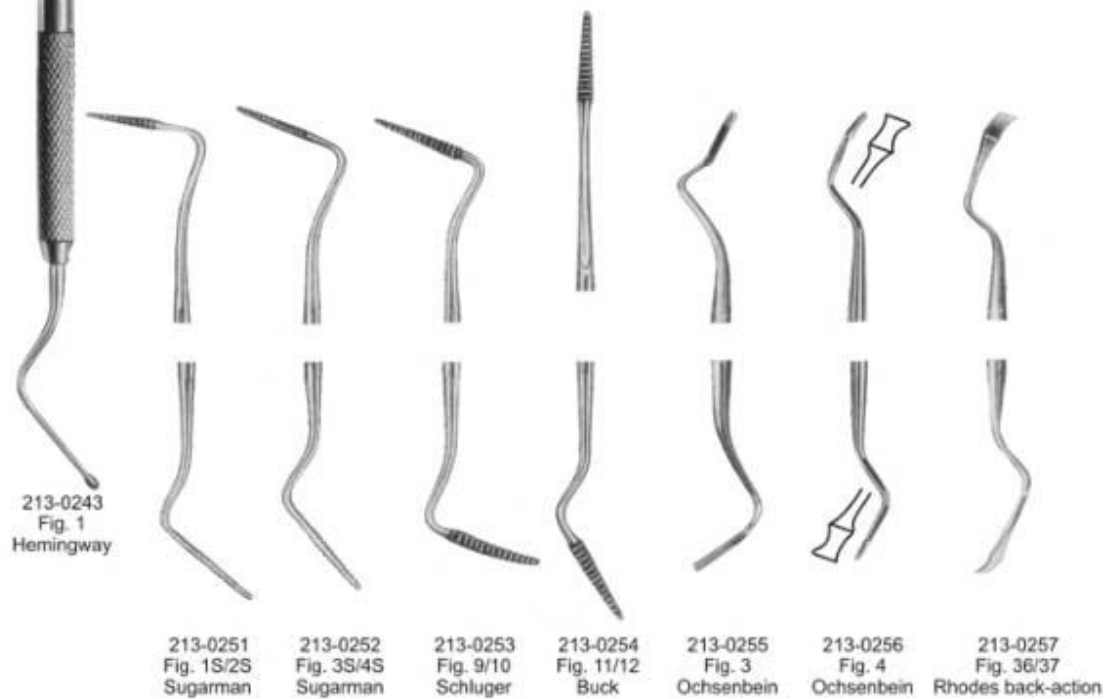
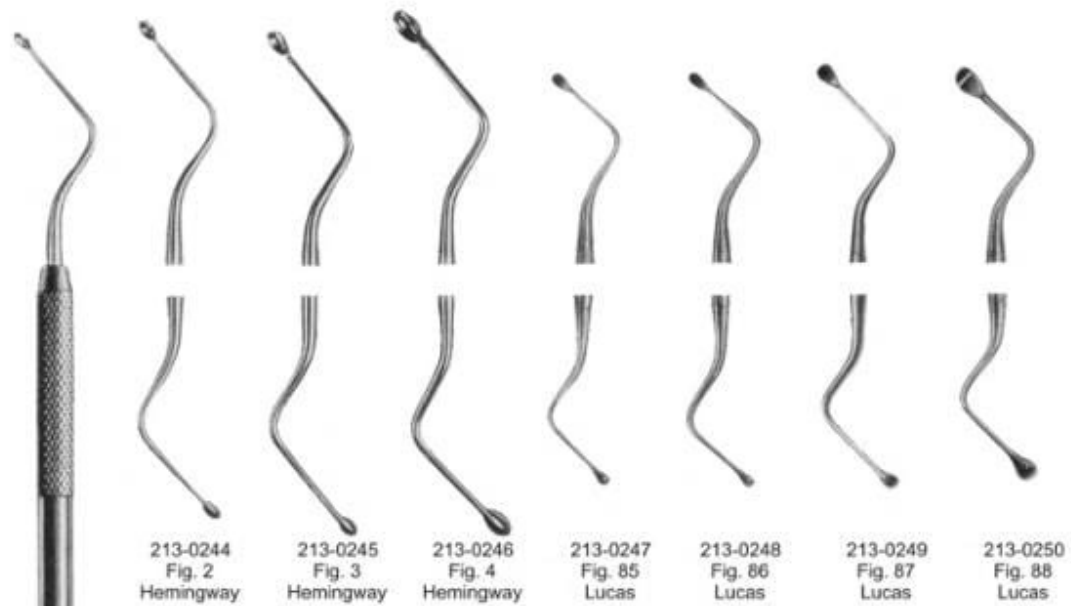

Set of 9 Pieces
Set of 7 Pieces

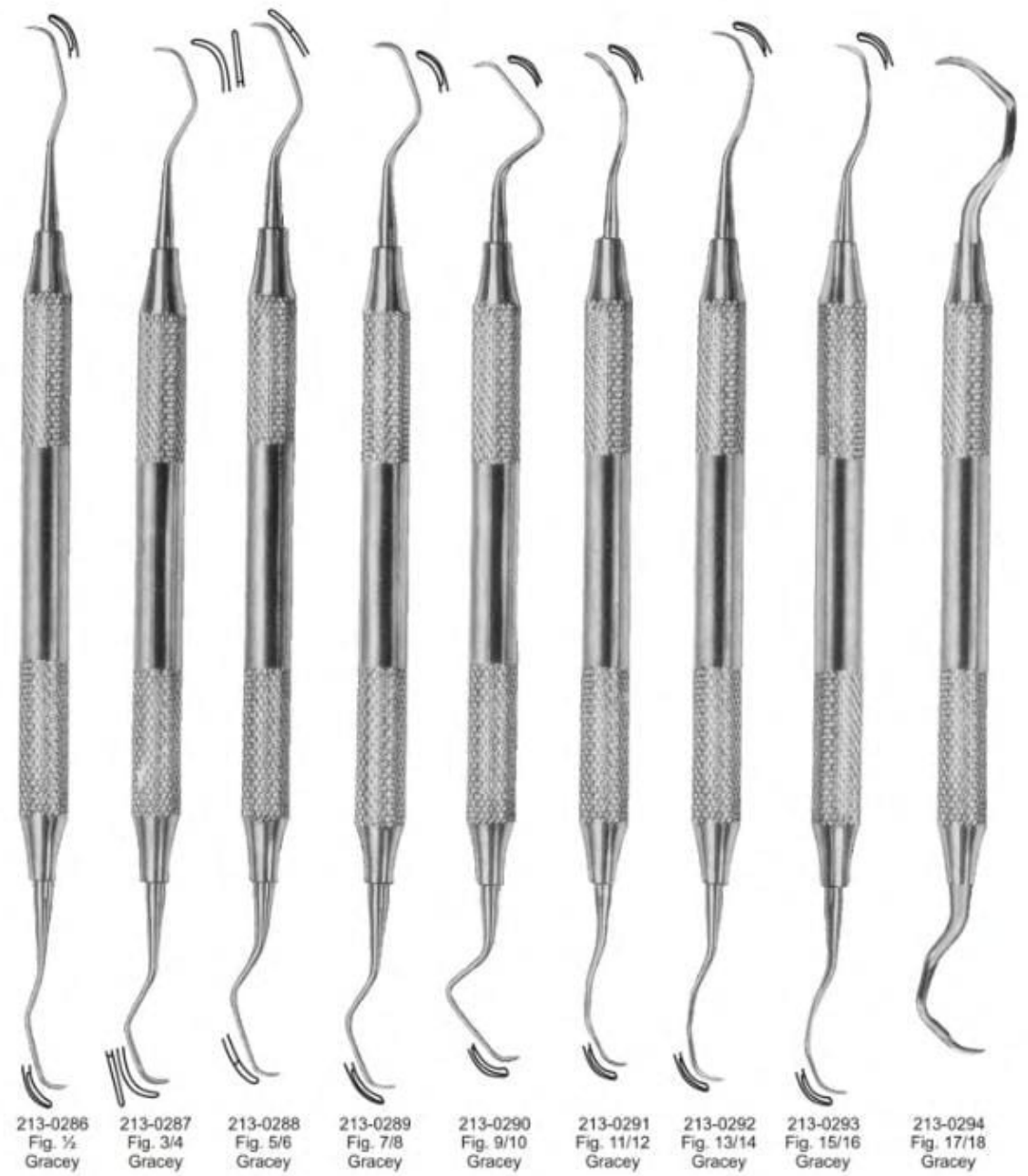
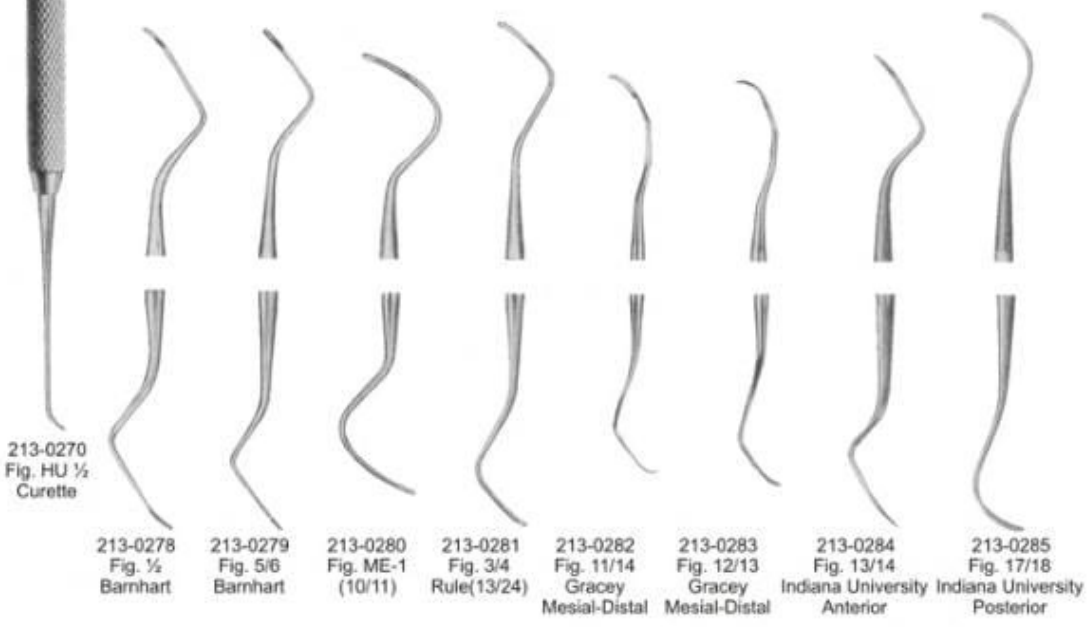
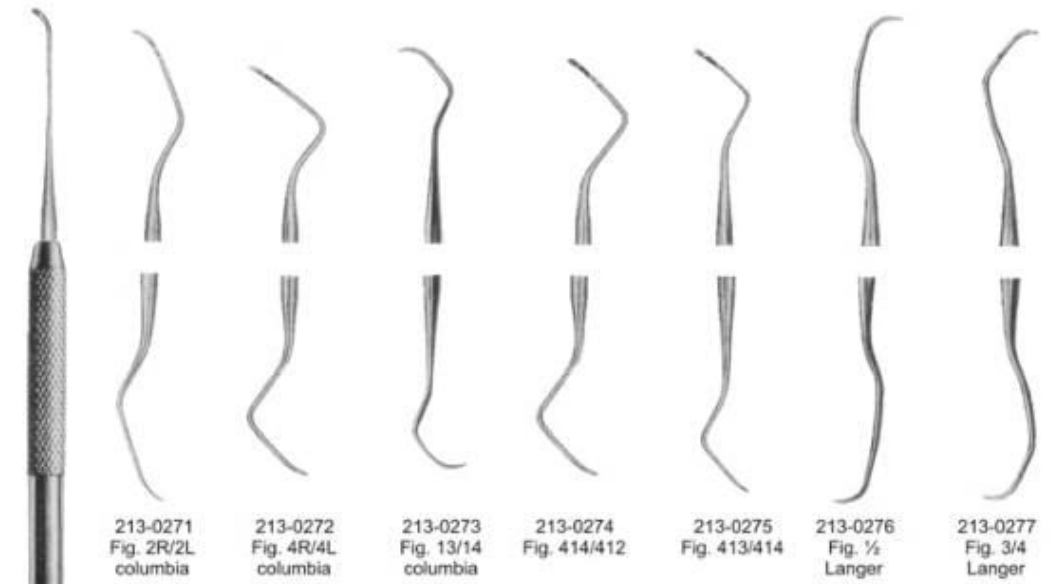



213-0296
Fig. 1
Goldman-fox



213-0297
Fig. 2
Goldman-fox



213-0298
Fig. 3
Goldman-fox



213-0299
Fig. 4
Goldman-fox



213-0300
Fig. 5
Goldman-fox



213-0301
Fig. 6
Goldman-fox



213-0302
Fig. 21
Goldman-fox

213-0295
Fig. 1
De Marco



213-0303
Fig. 2
De Marco



213-0304
Fig. 11/12
Mc call



213-0305
Fig. 11A/12A
Mc call



213-0306
Fig. 13/14
Mc call



213-0307
Fig. 13S/14S
Mc call



213-0308
Fig. 17S/14S
Mc call



213-0309
Fig. 19/20
Mc call



213-0310
Fig. 3/7
Hirschfeld
File



213-0311
Fig. 30/33
Jaquette



213-0312
Fig. 31/32
Jaquette



213-0313
Fig. 34/35
Jaquette



213-0314
Fig. 37/38
Jaquette

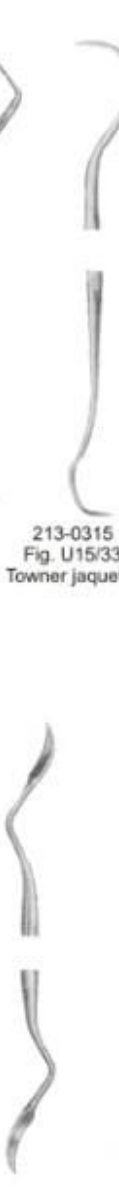

213-0315
Fig. U15/33
Towner jaquette

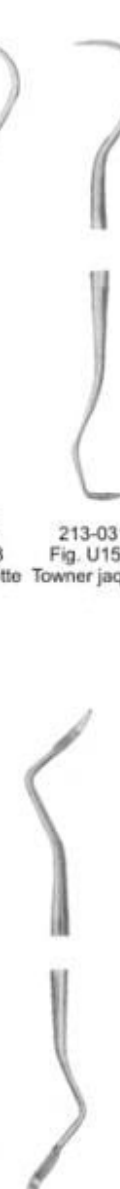

213-0316
Fig. U15/30
Towner jaquette



213-0317
Fig. H5/33



213-0318
Fig. H6/H7



213-0319
Fig. 2/3
Taylor



213-0320
Fig. 204

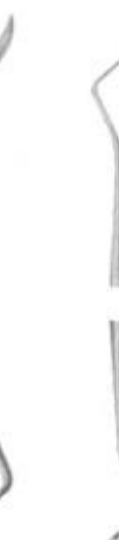

213-0321
Fig. 204S



213-0322
Fig. 2/3



213-0323
Fig. 6
Crane-Kaplan



213-0324
Fig. 7/8
Crane-Kaplan



213-0325
Fig. 1/2
Younger-Good

CEMENT SPATULAS





CARVERS

surgiprove@gmail.com

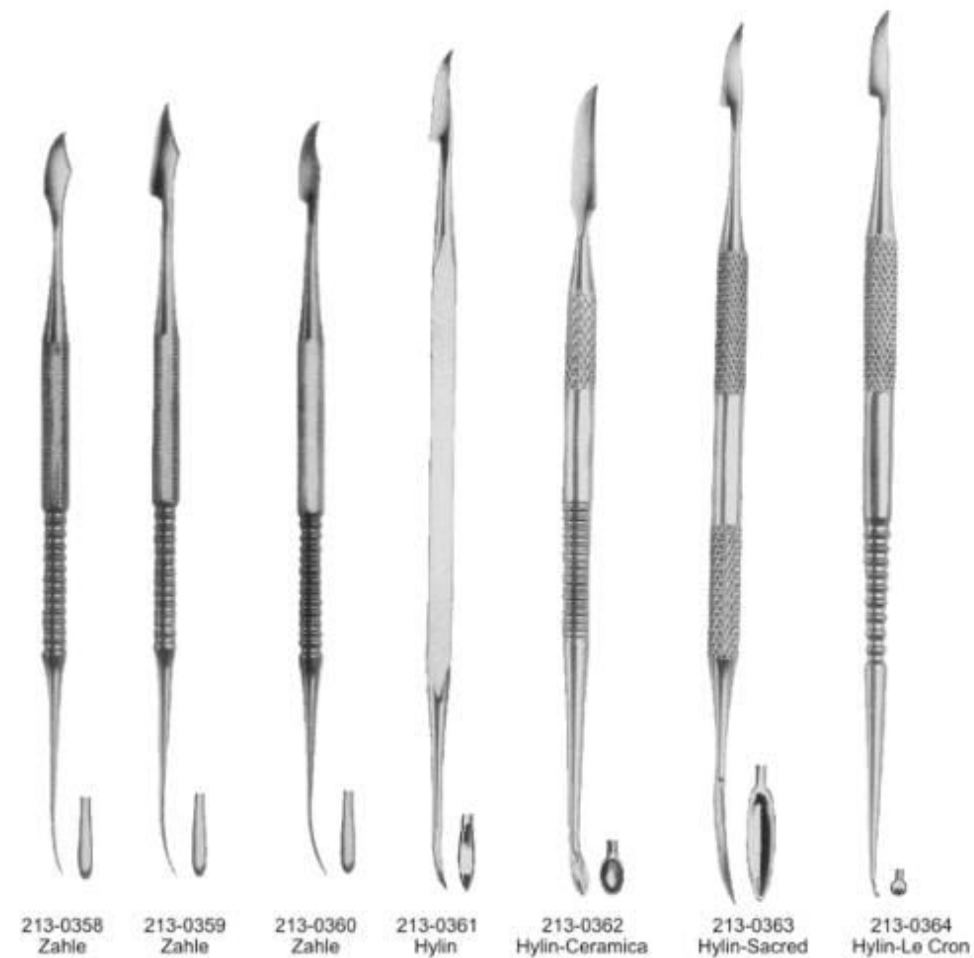



213-0366
Le Cron



213-0367
Le Cron



213-0368
Vehe



213-0369
Beale



213-0370
Roach



213-0371
Le cron



213-0372
Le cron



213-0373
Gritman

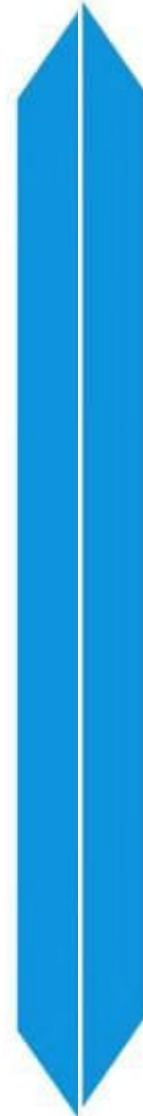

213-0374
Fig. 1
P. K. Thomas



213-0375
Fig. 2
P. K. Thomas



213-0376
Fig. 3
P. K. Thomas



213-0377
Fig. 4
P. K. Thomas



213-0378
Fig. 5
P. K. Thomas

WAX KNIVES



214-0001
Fig. 1
Fahnenstock
12.5 cm



214-0002
Fig. 1
Lessmann
12.5 cm



214-0003
Fig. 1
Con Scodelina



214-0004
Fig. 2
Fahnenstock



214-0005
Fig. 2
Lessmann



214-0006
Fig. 2
Con Scodelina

SPATULAS FOR PLASTER AND ALGINATE



214-0007
cm 17



214-0008
cm 17 Gritman



214-0009
cm 19.5



214-0010
cm 21.5



214-0011
cm 20.5



214-0012
cm 19.5



214-0013
cm 20



214-0014
cm 22.5

AMALGAM CARRIERS



215-0005
Jumbo
Amalgam Well





DENTAL CARTRIDGE SYRINGS

surgiprove@gmail.com



215-0012



215-0014



215-0016



215-0018



215-0020



215-0013



215-0015



215-0017



215-0019



215-0021



215-0022



215-0024



215-0026



215-0028



215-0030



215-0023



215-0025



215-0027



215-0029



215-0031



Chip bolwer



215-0032



215-0033



215-0034

215-0035
For 6 Films
215-0036
For 10 Films
215-0037
For 14 Films



Films Holder



215-0038
Water Syringe



215-0039
Water Syringe



215-0040
Napkin holder with plastic band

215-0041
Napkin holder with metal chain

MATRIX RETAINERS



215-0042-5mm
215-0043-6mm
215-0044-7mm
Ivory



215-0045
Ivory 8 N



215-0046
Ivory 8



215-0047
Siqveland-narrow
215-0048
Siqveland-wide



215-0049
Fig. 1
Toffemire-universal



215-0050
Fig. 2
Toffemire-senior



215-0051
Fig. 3
Toffemire-junior



215-0052
Fig. 2
Didher 8



215-0053
Ivory



215-0054
Ivory



215-0055
Ivory separator



CROWN INSTRUMENTS

surgiprove@gmail.com



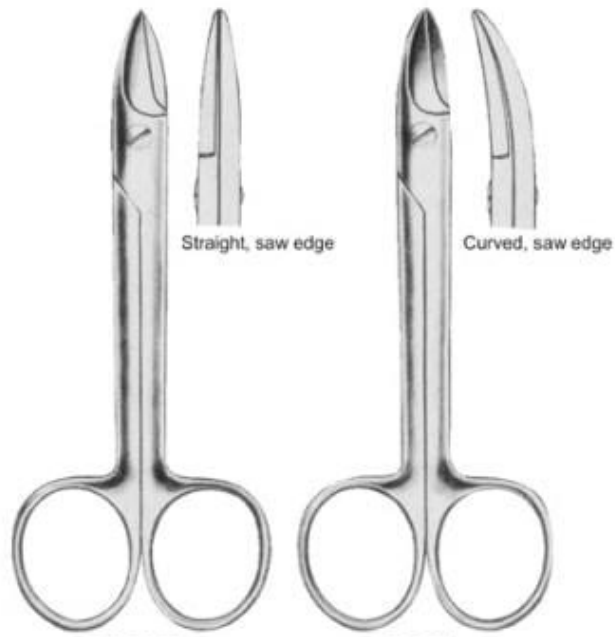

Straight, saw edge

Curved, saw edge

215-0056
Fig.1
10.5cm

215-0057
Fig.2
10.5cm

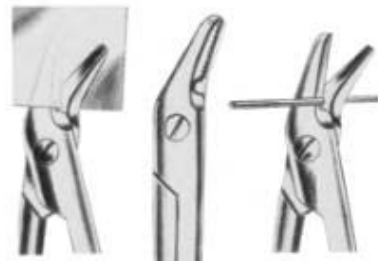

215-0058
Universal
12cm



215-0059
Lwanson



215-0060
Fig.3
Crown spreaders



215-0061
Boley
14cm



Universal

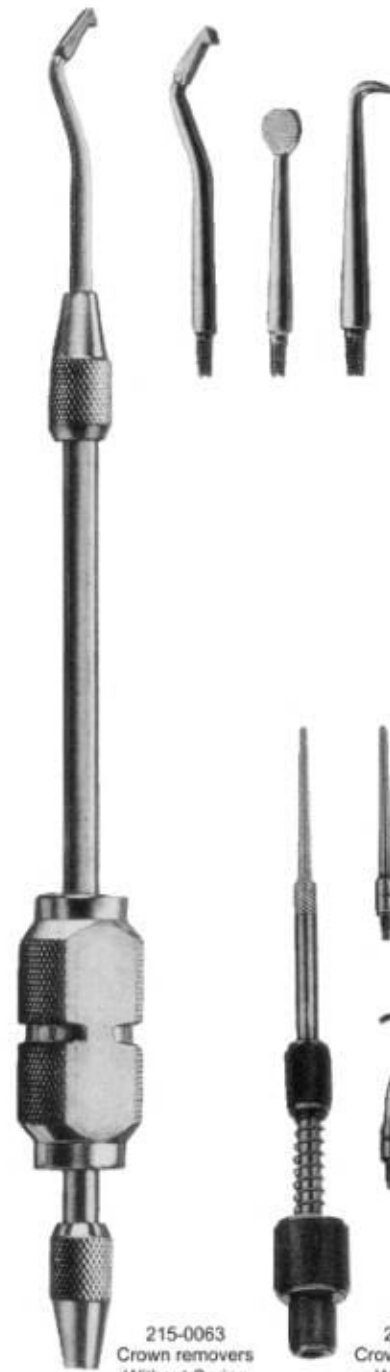

215-0063
Crown removers
Without Spring

215-0064
Crown removers
With Spring

With 5 Points

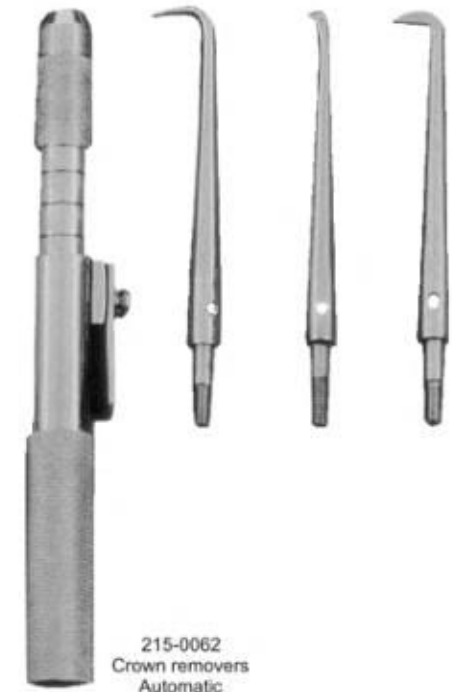

215-0062
Crown removers
Automatic



215-0065
Crown remover
Fully Automatic



215-0066
Articulating Paper Forcep
15cm



215-0067
Miller
15cm



215-0068
Crown Spreader



215-0069
Vernier Gauge Caliper
0mm to 80mm

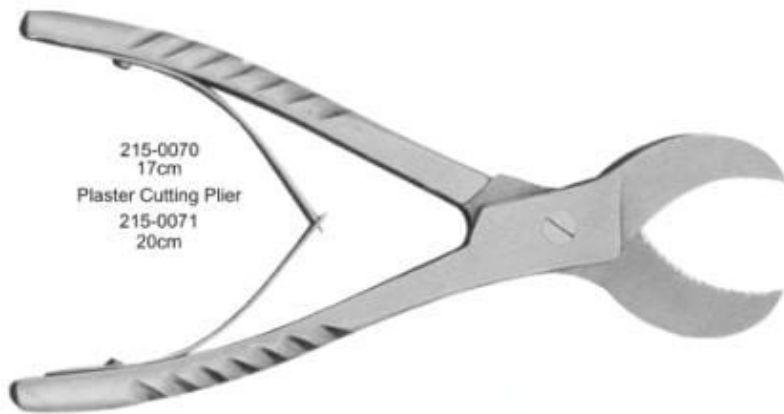

215-0070
17cm
Plaster Cutting Plier
215-0071
20cm



215-0072
Arch Turret with 5 wire-slots
.016", .017", .018", .020" and .022"

IMPRESSION TRAYS

surgiprove@gmail.com

Available in Set of 8
Code # Set - A001



All the above impression trays are available in these 4 sizes

UPPER	UPPER					LOWER	LOWER				
	U1	U2	U3	U4	U5		L1	L2	L3	L4	L5
A	62	60	53	54	52	A	63	61	57	60	53
B	63	75	73	69	68	B	82	81	78	74	71

All Dimension are in mm

All Dimension are in mm

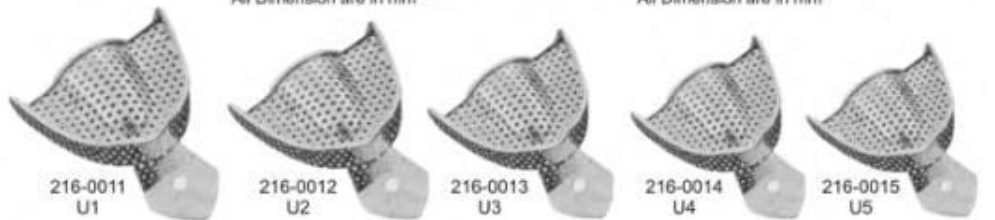

Available in Set of 8
Code # Set - A002

Available in Set of 8
Code # Set - A003

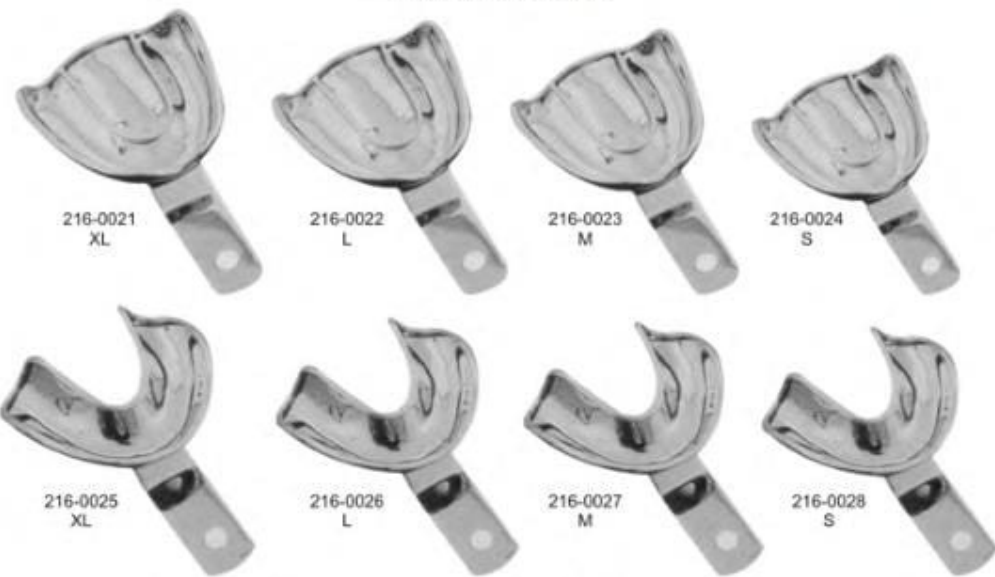

All the above impression trays are available in these 4 sizes

UPPER	UPPER				LOWER	LOWER			
	XL	L	M	S		XL	L	M	S
A	70	67	64	60	A	64	64	60	57
B	79	78	70	73	B	86	70	73	70

All Dimension are in mm

All Dimension are in mm



Available in Set of 8
Code # Set - A004

Available in Set of 6
Code # Set - A005



All the above impression trays are available in these 4 sizes

LOWER		L1	L2	L3
	A	67	64	57
	B	81	71	70

All Dimension are in mm

LOWER		L1	L2	L3
	A	60	57	64
	B	84	79	76

All Dimension are in mm

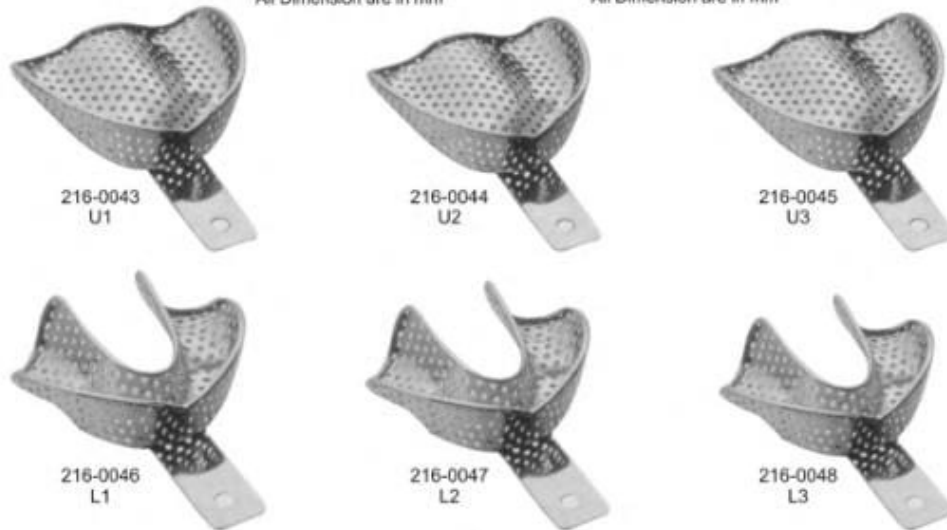

Available in Set of 6
Code # Set - A006

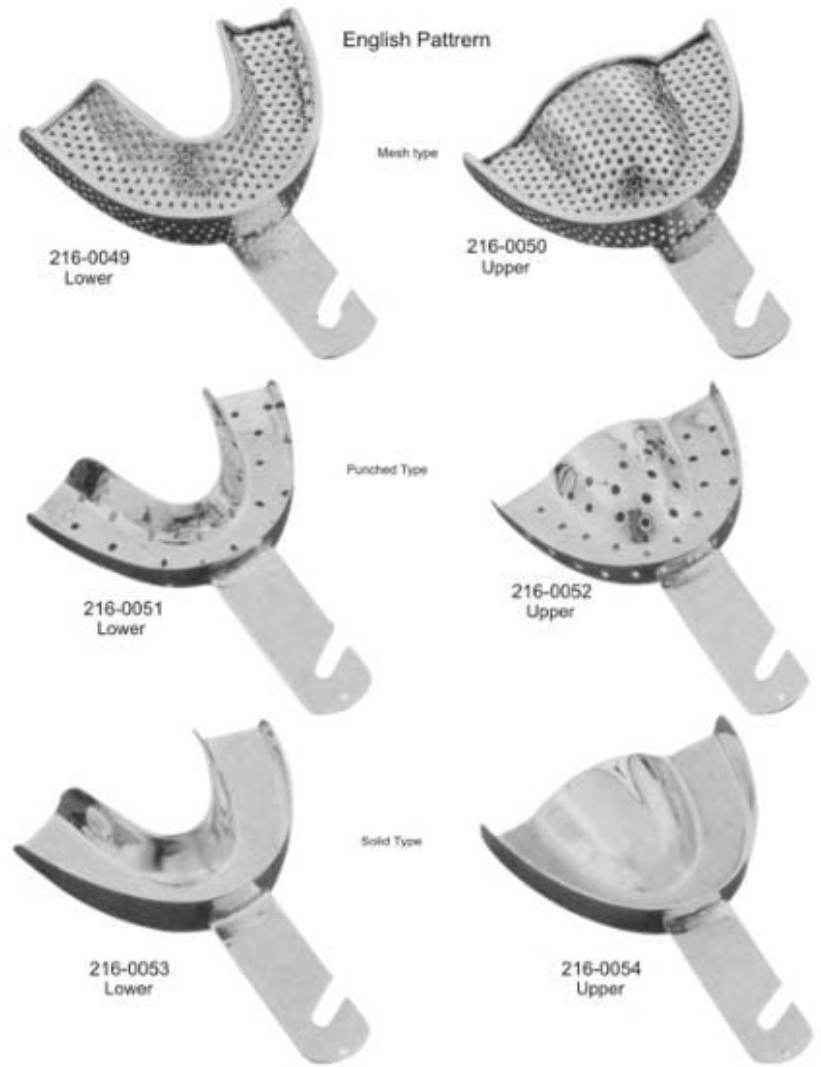

All the above impression trays are available in these 4 sizes

UPPER	Size	A	B	C
	0	67	50	12
	1	72	51	13
	2	78	55	15
	3	80	58	15

All Dimension are in mm

LOWER	Size	A	B	C
	0	70	50	12
	1	77	51	13
	2	7	55	15
	3	80	50	15

All Dimension are in mm

Available in Set of 8
Code # Set - A007

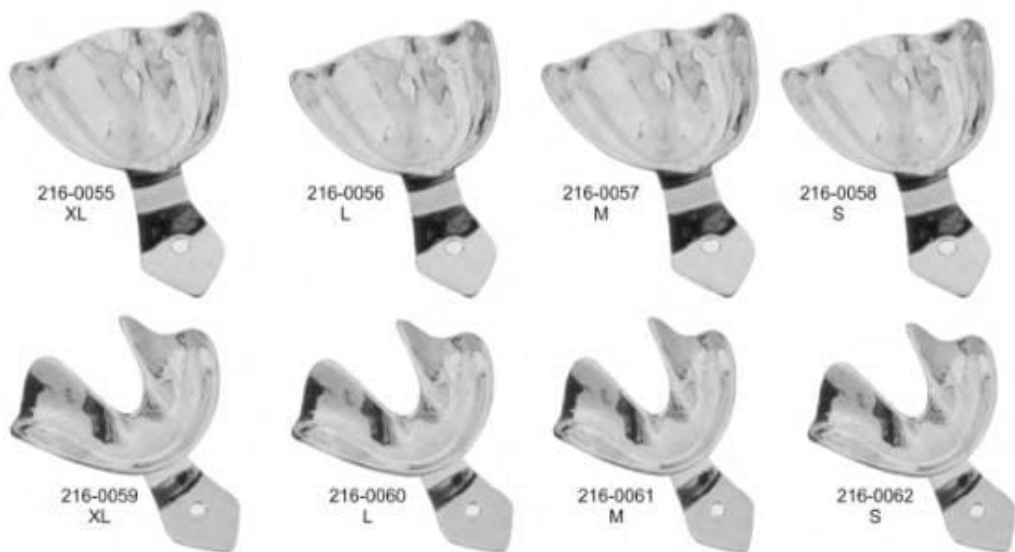

All the above impression trays are available in these 4 sizes

UPPER		XL	L	M	S	
		A	70	67	64	60
LOWER		XL	L	M	S	
		A	64	64	60	57
UPPER		B	79	78	70	73
		LOWER		B	86	70

All Dimension are in mm

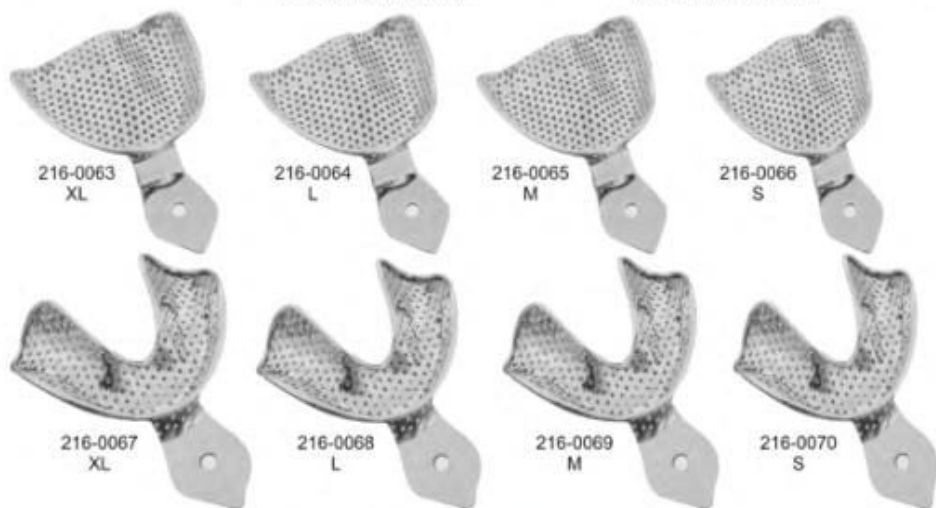

Available in Set of 8
Code # Set - A008

Available in Set of 8
Code # Set - A009

For crown & bridgework Impression Trays

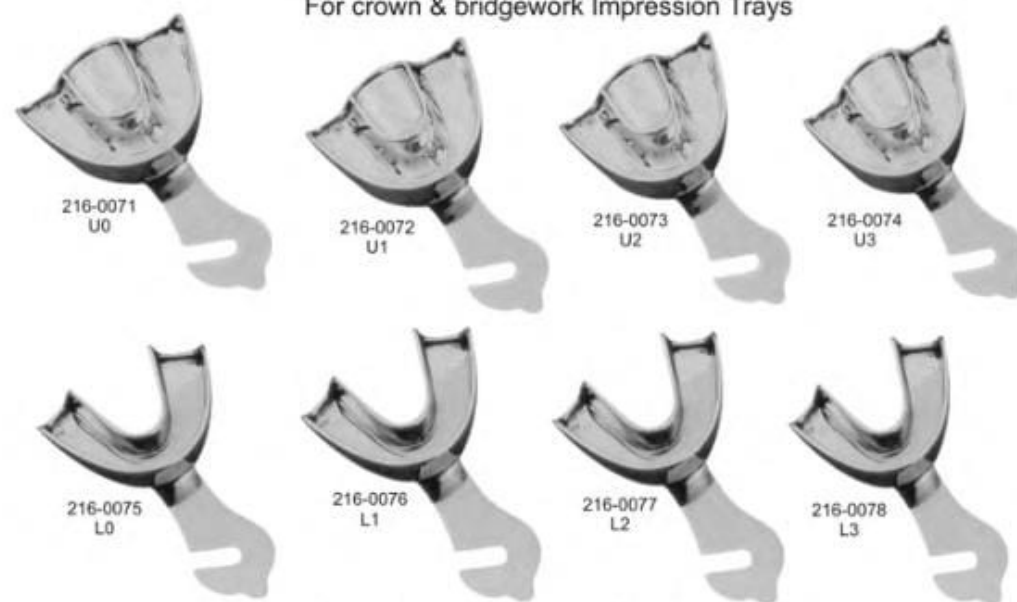

Upper Sizes 0,1,2,3,
Depth of the tray 19,9 mm
Height of palate 12,5 mm

Lower Sizes 0,1,2,3,
Depth of the tray 12,9 mm

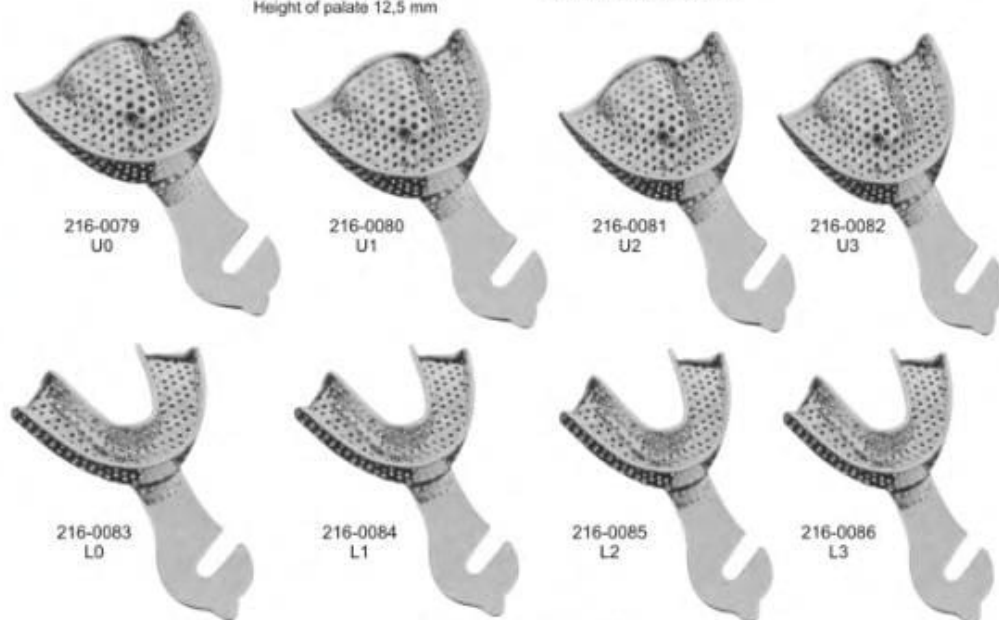

Available in Set of 8
Code # Set - A010

Impression trays for crown & bridge work



216-0087
U1P

Solid

216-0088
L1P

216-0089
U1P

Perforated

216-0090
L1P



Perforated

216-0091
For upper right jaw
For lower left jaw

216-0092
For upper left jaw
For lower right jaw



216-0093
Adjustable
Perforated



216-0094
Adjustable
Solid

Available in 4 Sizes

- 1.....44 mm
- 2.....55 mm
- 3.....60 mm
- 4.....65 mm

Also available in Solid pattern

INSTRUMENT TRAYS



217-0001
Scaler Sterilizing Tray
For 5-pcs
18 x 6 x 2 cm



217-0002
Scaler Sterilizing Tray
For 5-pcs
18 x 6.5 x 2 cm



217-0003
Scaler Sterilizing Tray
For 10-pcs
18 x 12.5 x 2 cm



217-0004
Scaler Sterilizing Tray
For 10-pcs
18 x 14 x 2 cm

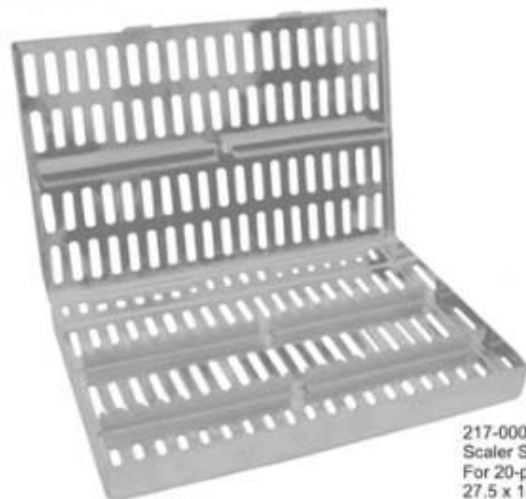

217-0005
Scaler Sterilizing Tray
For 20-pcs
27.5 x 18 x 2.5 cm



HOLLOWWARE ITEMS

surgiprove@gmail.com

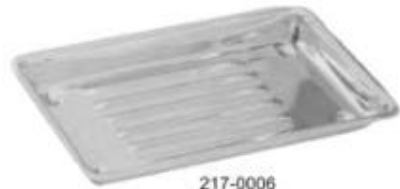

217-0006
Scalers Tray



Instruments Box

217-0007
10"×6"×2"
217-0008
12"×8"×2½"
217-0009
16"×12"×4"

217-0010
8"×6"×2"
217-0011
10"×8"×2"
217-0012
12"×8"×2½"
217-0013
12"×10"×2½"
217-0014
14"×10"×2½"
217-0015
14"×12"×2½"



Instruments Tray with Lid



Instruments Tray without Lid

217-0016
8"×6"×2"
217-0017
10"×8"×2"
217-0018
12"×8"×2½"
217-0019
12"×10"×2½"
217-0020
14"×10"×2½"
217-0021
14"×12"×2½"



217-0022
8"×3"×1½"
Instruments Box



217-0023
Endodontic box

217-0024
10"×6"×2"
217-0025
12"×8"×2½"
217-0026
16"×12"×4"

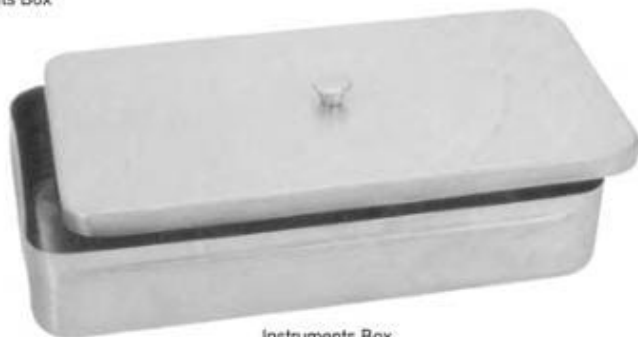

Instruments Box

Ø Depth
217-0027 2" × 2"
217-0028 4" × 2"
217-0029 5½" × 2½"
217-0030 6" × 2½"
217-0031 7" × 3½"
217-0032 8" × 3½"
217-0033 10" × 4"



Lotion Bowl



Kidney Trays

217-0034
217-0035
217-0036
217-0037



217-0038
6"×9"
Sterilizing Drum
217-0039
8"×12"



217-0040
10"×10"
Sterilizing Drum



217-0041
Cotton Holder



217-0042
80 × 35 mm
Medicine Cup
217-0043
125 × 60 mm

217-0046
25 × 80 mm
217-0047
30 × 100 mm
217-0048
75 × 173 mm
217-0049
100 × 200 mm



217-0044
Spirit Lamp



217-0045
Spirit Lamp

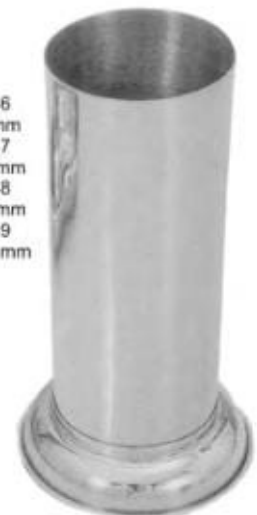

Force Jar



217-0050
5cm×15cm
Force Jar
217-0051
5cm×10cm

RUBBERDAM CLAMPS

Molar Clamps Winged



218-0001
Fig. 30



218-0002
Fig. 31



218-0003
Fig. 51



218-0004
Fig. 138



218-0005
Fig. 139



218-0006
Fig. 15



218-0007
Fig. 18



218-0008
Fig. 24



218-0009
Fig. 25



218-0010
Fig. 26



218-0011
Fig. 28

Bicuspid Clamps Winged



218-0012
Fig. 206



218-0013
Fig. 207



218-0014
Fig. 208



218-0015
Fig. 209



218-0016
Fig. 22



218-0017
Fig. 27



218-0018
Fig. 29

Molar Clamps Winged



218-0019
Fig. 26A



218-0020
Fig. 28A



218-0021
Fig. 30A



218-0022
Fig. 31A



218-0023
Fig. 51A

Bicuspid Clamps Winged



218-0024
Fig. 27



218-0025
Fig. 29



218-0026
Fig. 60

Molar Clamps Winged



218-0027
Fig. 200



218-0028
Fig. 201



218-0029
Fig. 202



218-0030
Fig. 203



218-0031
Fig. 204



218-0032
Fig. 205

Labial Clamps Winged



218-0033
Fig. 210



218-0034
Fig. 211



218-0035
Fig. 212



219-0001



219-0002



219-0003



219-0004



219-0005



219-0006

ARTICULATOR



IMPRESSION TRAYS SET

surgiprove@gmail.com

220-0001



220-0002



220-0003

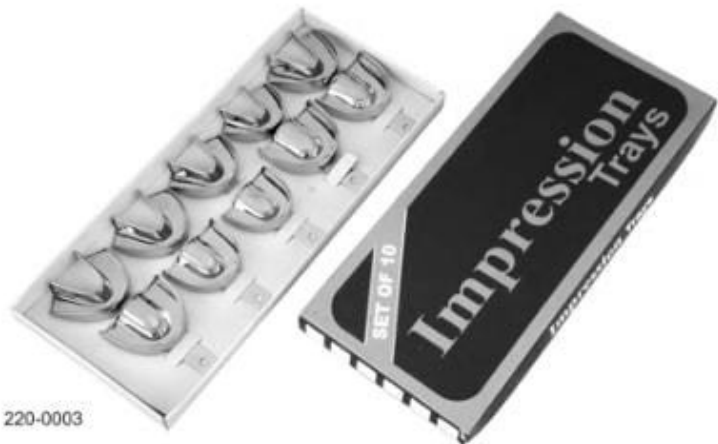

220-0004



220-0005



220-0006





INSTRUMENTS PACKINGS

surgiprove@gmail.com



220-0007



220-0008



220-0009



220-0016



220-0017



220-0018



220-0010



220-0011



220-0012



220-0019



220-0020



220-0013



220-0014



220-0015



220-0021



220-0022



220-0023

THANK YOU



SURGI PROVE

www.surgiprove.com



surgiprove@gmail.com



+923307020002

A woman in a hospital setting, wearing a teal scrub top and a name tag, is pointing at a large medical monitor. The monitor displays anatomical diagrams of the human body, including the spine and internal organs. The background shows a window with blinds and a desk with a chair.

SURGIPROVE

SURGICAL SUPPLIERS

TC INSTRUMENTS



FM - 09-101 Hedgeman Scissor
175mm (7")
Angled to side 45, 60, 90, 125 degrees



FM - 09-102 Kelly Scissors
140mm (5.1/2")
150mm (6")
170mm (6.3/4")



FM - 09-105 Metzenbaum Scissors
115mm (4.1/2")
145mm (5.3/4")
180mm (7")
200mm (8")



FM - 09-103 Mayo Scissors
140mm (5.1/2")
150mm (6")
170mm (6.3/4")
200mm (8")



FM - 09-106 Dressing Scissors
112mm (5")
145mm (5.3/4")
150mm (6")
180mm (7")
200mm (8")



FM - 09-104 Iris Scissors
110mm (4.3/8")



FM - 09-107 Castroviejo Scissors
145mm (5.3/4")
180mm (7")
215mm (8.1/2")



FM-10.381
Mayo Hegar
Needle Holders
TC (16cm)



FM-10.382
Hegar Baumgartner
Needle Holders
TC (14cm)



FM-10.383
DERF
Needle Holders
TC (14cm)



FM-10.384
Nievert
Needle Holders
TC (13cm)



FM-10.385
Webster
Needle Holders
TC (13cm)

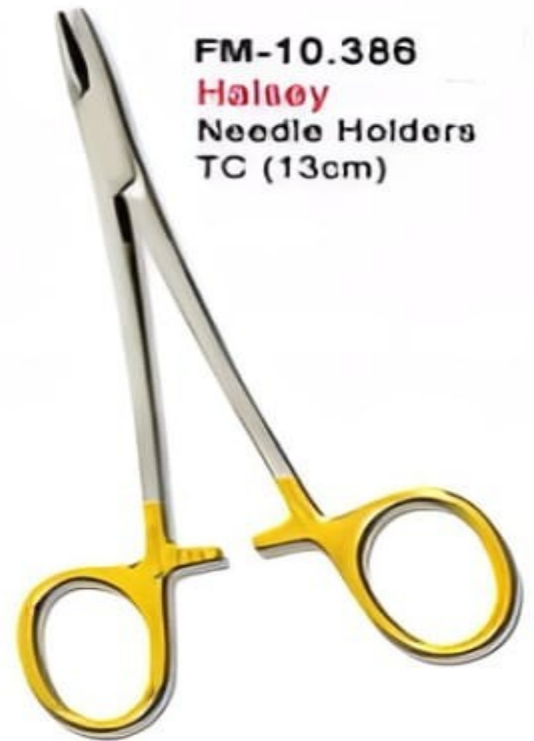

FM-10.386
Halvey
Needle Holders
TC (13cm)

FM-10.388

Serot

Needle Holders
TC (18cm)



FM-10.390

Olsen Hegar

Needle Holders
TC (14cm)



FM-10.392

Haney

Needle Holders
TC (20cm)



FM-10.387

Bozemann

Needle Holders
TC (20cm)



FM-10.389

Mathieu

Needle Holders
TC (14cm)



FM-10.391

Castroviejo

Needle Holders
TC (14cm)



FM-10.393

Masson

Needle Holders
TC (27cm)





FM-10.394
Wangensteen
Needle Holders
TC (27cm)



FM-10.395
Debaquey
Needle Holders
TC (18cm)

FM-10.396
Finochietto
Needle Holders
TC (20cm)



FM-10.397
Crile-Wood
Needle Holders
TC (15cm)



FM-10.399
Gillies
Needle Holders
TC (16cm)



FM-10.398
Kilner
Needle Holders
TC (14cm)



THANK YOU



SURGI PROVE

www.surgiprove.com



surgiprove@gmail.com



+923307020002



SURGIPROVE

Beauty instruments

Professional Hair cutting, barber & thinning scissors

- The unique manufacturing process ensure the necessary precision of concave inner surfaces (Hollow Ground) and convex outer surface of the scissors blades. The convex edged scissors blades are characterized by there exceptionally durable cutting edge. All metal masters scissors can be fitted with tension adjustment screw to ensure the ease of use which will cause minimum hand fatigue.

Top 4 Categories of SURGIPROVE Beauty instruments

“Our beauty instruments are an extension of my passion for helping clients unlock their full beauty potential. From the precision-crafted tweezers that shape and define brows, every tool in my collection is carefully selected to ensure exceptional results. Each instrument is meticulously cleaned and maintained to ensure sanitation and longevity, allowing me to focus on what matters most-crafting bespoke beauty experiences that leave my clients feeling confident and radiant.”



Hair cutting, Barber & thinning scissors

SECTION#1

PROFFESIONAL HAIR
CUTTING SCISSORS

SG-1001
Professional Hair Cutting Scissor
Size : 5' 5.5" 6' 6.5"



SG-1006
Star Professional Hair Cutting Scissor
Size : 5' 5.5" 6' 6.5"



SG-1002
Professional Hair Cutting Scissor
Size : 5' 5.5" 6' 6.5"



SG-1007
Professional Hair Cutting Scissor
Size : 5' 5.5" 6' 6.5"



SG-1003
Professional Hair Cutting Scissor
Size : 5' 5.5" 6' 6.5"



SG-1008
Professional Hair Cutting Scissor
Size : 5' 5.5" 6' 6.5"



SG-1004
Professional Hair Cutting Scissor
Size : 5' 5.5" 6' 6.5"



SG-1009
Professional Hair Cutting Scissor
Half Gold Plated.
Size : 5' 5.5" 6' 6.5"



SG-1005
Professional Hair Cutting Scissor
Size : 5' 5.5" 6' 6.5"



SG-1010
Professional Hair Cutting Scissor
Size : 5' 5.5" 6' 6.5"



SG-1011
Professional Hair Cutting Scissor
Size : 5' 5.5" 6' 6.5"



SG-1016
Professional Hair Cutting Scissor
Size : 5' 5.5" 6' 6.5"



SG-1012
Professional Hair Cutting Scissor
Size : 5' 5.5" 6' 6.5"



SG-1017
Professional Hair Cutting Scissor
Size : 5' 5.5" 6' 6.5"



SG-1013
Professional Hair Cutting Scissor
Size : 5' 5.5" 6' 6.5"



SG-1018
New Professional Hair Cutting Scissor
Size : 5' 5.5" 6' 6.5"



SG-1014
Professional Hair Cutting Scissor
Size : 5' 5.5" 6' 6.5"



SG-1019
Jacky Style Professional
Hair Cutting Scissor
Size : 5' 7.5"



SG-1015
Left Hand Professional
Hair Cutting Scissor
Size : 5' 5.5" 6' 6.5"



SG-1020
Revolving Thumb Professional Hair
Cutting Scissor with three finger holes
Size : 5' 5.5" 6' 6.5"





SG-1021
Professional Hair Cutting Scissor
Size : 5" 5.5" 6" 6.5"



SG-1026
Professional Hair Cutting Scissor
Size : 5" 5.5" 6" 6.5"



SG-1022
Professional Hair Cutting Scissor
Size : 5" 5.5" 6" 6.5"



SG-1027
Professional Hair Cutting Scissor
Multicolor Coated
Size : 5" 5.5" 6" 6.5"



SG-1023
Professional Hair Cutting Scissor
with Three Finger Holes
Size : 5" 5.5" 6" 6.5"



SG-1028
Revolving Thumb Professional
Hair Cutting Scissor
Multicolor Coated
Size : 5" 5.5" 6" 6.5"



SG-1024
Professional Hair Cutting Scissor
Size : 5" 5.5" 6" 6.5"



SG-1029
Professional Hair Cutting Scissor
Gold Plated.
Size : 5" 5.5" 6" 6.5"



SG-1025
Professional Hair Cutting Scissor
Size : 5" 5.5" 6" 6.5"



SG-1030
Professional Hair Cutting Scissor
Gold Plated.
Size : 5" 5.5" 6" 6.5"



SG-1031
Professional Hair Cutting Scissor
Titanium Coated.
Size : 5" 5.5" 6" 6.5"



SG-1036
Professional Hair Cutting
Scissor Paper Coated.
Size : 5" 5.5" 6" 6.5"



SG-1032
Professional Hair Cutting Scissor
Titanium Coated with Keychain
Size : 5" 5.5" 6" 6.5"



SG-1037
New Fishbone Professional
Hair Cutting Scissor
Paper Coated.
Size : 5" 5.5" 6" 6.5"



SG-1033
Professional Hair Cutting Scissor
Powder Coated Pink.
Size : 5" 5.5" 6" 6.5"



SG-1038
Professional Hair Cutting
Scissor Paper Coated.
Size : 5" 5.5" 6" 6.5"



SG-1034
Professional Hair Cutting
Scissor Paper Coated.
Size : 5" 5.5" 6" 6.5"



SG-1039
Professional Hair Cutting
Scissor Paper Coated.
Size : 5" 5.5" 6" 6.5"



SG-1035
Professional Hair Cutting
Scissor Powder Coated Black.
Size : 5" 5.5" 6" 6.5"



SG-1040
Professional Hair Cutting
Scissor Paper Coated.
Size : 5" 5.5" 6" 6.5"

SG-1051
Professional
Pet Grooming Scissor.
Size : 7" 8" 9" 10" 11"



SG-1057
Professional
Safety Scissor.
Size : 7" 8" 9"



SG-1052
Professional
Pet Grooming Scissor.
Size : 7" 8" 9" 10" 11"



SG-1058
Professional
Pet Grooming Scissor.
Size : 7" 8" 9" 10"



SG-1053
Professional
Pet Grooming Scissor.
Size : 7" 8" 9" 10"



SG-1059
Professional
Pet Grooming Scissor.
Size : 7" 8" 9" 10" 11"



SG-1054
Professional
Pet Grooming Scissor.
Size : 7" 8" 9" 10"



SG-1060
Professional
Pet Grooming Scissor.
Size : 7" 8" 9" 10" 11"



SG-1055
Professional
Pet Grooming Scissor.
Size : 7" 8" 9" 10"



SG-1061
Professional
Pet Grooming Scissor.
Size : 9.5"



SG-1056
Professional
Pet Grooming Scissor.
Size : 7" 8" 9" 10"



SG-1062
Professional Thinning
Pet Grooming Scissor.
Size : 7" 8" 9" 10"



PET GROOMING SCISSORS

SUPER CUT BARBER SCISSORS

SG-1041
Hair dressing Scissor
with Finger rest
Size : 5.5" 6"



SG-1046
Hair Dressing Scissor
Size : 5.5" 6"



SG-1042
Delicate Cut Professional
Hair Cutting Scissor
Size : 5.5" 6"



SG-1047
Ambidextrous Style
Barber Scissor
Size : 5.5", 6"



SG-1043
Hair Dressing Scissor
with Finger rest
Size : 5.5" 6"



SG-1048
Barber Scissor with Finger
Rest, Plastic Handle
Size : 5.5", 6"



SG-1044
Hair Dressing Scissor
with Finger rest
Size : 5.5" 6"



SG-1049
Barber Scissor with Finger
Rest, Plastic Handle
Size : 5.5", 6"



SG-1045
Hair Dressing Scissor
with Finger rest
Size : 5.5" 6"



SG-1050
Barber Thinning Scissor
Plastic Handle
Size : 5.5", 6"



HAIR THINNING SCISSORS



SG-1101
Professional Hair Thinning Scissor
Size : 5.5"



SG-1106
Professional Hair Thinning Scissor
Size : 5.5"



SG-1102
Professional Hair Thinning Scissor
Size : 5.5"



SG-1107
Professional Hair Thinning Scissor
Size : 5.5"



SG-1103
Professional Hair Thinning Scissor
Size : 5.5"



SG-1108
Professional Hair Thinning Scissor
Size : 5.5"



SG-1104
Professional Hair Thinning Scissor
Size : 5.5"



SG-1109
Professional Hair Thinning Scissor
Size : 5.5"



SG-1105
Professional Hair Thinning Scissor
Size : 5.5"



SG-1110
Professional Hair Thinning Scissor
Size : 5.5"



SG-1111
Professional Hair Thinning Scissor
Size : 5.5"



SG-1116
Professional Hair Thinning Scissor
Size : 5.5"



SG-1112
Professional Hair Thinning Scissor
Size : 5.5"



SG-1117
Professional Hair Thinning Scissor
Size : 5.5"



SG-1113
Fishbone Style Professional
Hair Thinning Scissor
Size : 5.5"



SG-1118
Professional Hair Thinning Scissor
Multicolor Coated. Size : 5.5"



SG-1114
Professional Hair Thinning Scissor
Size : 5.5"



SG-1119
Professional Hair Thinning Scissor
Multicolor Coated. Size : 5.5"



SG-1115
Professional Hair Thinning Scissor
Size : 5.5"



SG-1120
Professional Hair Thinning Scissor
Titanium Coated. Size : 5.5"



SG-1121
Professional Hair Thinning Scissor
Titanium Coated. Size : 5.5"



SG-1126
Professional Hair Thinning Scissor
Paper Coated. Size : 5.5"



SG-1122
Professional Hair Thinning Scissor
Titanium Coated. Size : 5.5"



SG-1127
Professional Hair Thinning Scissor
Paper Coated. Size : 5.5"



SG-1123
Professional Hair Thinning Scissor
Titanium Coated. Size : 5.5"



SG-1128
Professional Hair Thinning Scissor
Paper Coated. Size : 5.5"



SG-1124
Professional Hair Thinning Scissor
Paper Coated. Size : 5.5"



SG-1129
Professional Hair Thinning Scissor
Paper Coated. Size : 5.5"



SG-1125
Professional Hair Thinning Scissor
Paper Coated. Size : 5.5"



SG-1130
Professional Hair Thinning Scissor
Paper Coated. Size : 5.5"

NAIL, CUTICLE
SCISSORS &
TWEEZERS



SG-1151
Nail Scissor, Size: 9 cm
Straight

SG-1152
Arrow Point Cuticle
Scissor, Size: 9 cm
Curved

SG-1153
Cuticle Scissor, Size: 9 cm
Straight

SG-1154
Nail Scissor, Size: 9 cm
Curved

SG-1155
Nail Scissor, Size: 9 cm
Straight



SG-1156
Arrow Point Cuticle
Scissor, Size: 9.5 cm
Straight

SG-1157
Cuticle Scissor, Size: 9 cm
Straight

SG-1158
Cuticle Scissor, Size: 9.5 cm
Straight

SG-1159
Mustache Scissor
Like Real Screw Size: 9 cm
Straight

SG-1160
Nail Scissor
Size: 9 cm, 10 cm
Straight



SG-1161
Cuticle Scissor Size: 6 cm
Curved

SG-1162
Cuticle Scissor Size: 6 cm
Straight

SG-1163
Arrow Point Cuticle Scissor
Size: 9 cm, Curved

SG-1164
Toe Nail Scissor Size: 10 cm
Straight

SG-1165
Safety Nose Hair Scissor
Size: 9 cm, Straight



SG-1166
Safety Scissor
Size: 9 cm, Straight

SG-1167
Safety Scissor
Size: 9.5 cm, Straight

SG-1168
Pocket Scissor
Size: 10, 11 cm, Curved

SG-1169
Nail & Cuticle Scissor
Size: 6 cm, Straight

SG-1170
Spencer Scissor
Size: 9 cm, Straight



SG-1171
Spencer Scissor
Size: 9 cm, Curved

SG-1172
Nail Scissor
Size: 9.5 cm

SG-1173
Nail Scissor
Size: 9.5 cm, Curved

SG-1174
Fine Cuticle Scissor
Size: 9 cm, Curved

SG-1175
Arrow Point Cuticle Scissor
Size: 9 cm



SG-1176
Arrow Point Cuticle Scissor
Size: 9 cm

SG-1177
Arrow Point Cuticle Scissor
Size: 11 cm

SG-1178
Eye brow Scissor
Curved

SG-1179
Eye brow Scissor
Straight



SG-1180
Arrow Point Cuticle
Scissor, Size: 9 cm
Curved



SG-1181
Cuticle Scissor
Size: 9 cm, Curved



SG-1182
Safety Scissor with
Rubber Rings, Size: 9 cm
Straight



SG-1183
Nail Scissor with
Rubber Rings, Size: 9 cm
Straight



SG-1184
Tweezer Scissor,
Size: 9 cm



SG-1185
Embroidery Scissor
Size: 18 cm, Straight



SG-1186
Embroidery Scissor
Size: 9 cm, Straight



SG-1187
Stork Scissor, Size: 9 cm
Straight



SG-1188
Hen Scissor, Size: 10 cm
Straight



SG-1189
Cuticle Angled Toe
Nail Scissor
Size: 10 cm
Curved



SG-1190
Fancy Scissor, Size: 10 cm
Straight



SG-1191
Embroidery Scissor,
Size: 9 cm, Straight



SG-1192
Butterfly Scissor,
Size: 9 cm Straight



SG-1193
Rabbit Scissor
Size: 9 cm, Straight



SG-1194
Embroidery Scissors,
Size: 10 cm, Straight



SG-1195
Cuticle Nail Scissors,
Size: 9 cm, Straight



SG-1196
Fish Scissor, Size: 9 cm
Straight



SG-1197
Stork Scissor,
Size: 9 cm, Straight



SG-1198
Cuticle Nail Scissor,
Size: 9 cm, Straight



SG-1199
Arrow Point Cuticle Scissor
long Blade, Size: 9.5 cm
Straight



SG-1200
Arrow Point Cuticle Scissor
long Blade, Size: 9.5 cm
Straight



SG-1201
Arrow Point Cuticle Scissor
Size: 11 cm, Curved



SG-1202
Cuticle Nail Scissor
Size: 10 cm, Straight



SG-1203
Cuticle Scissor
Size: 9.5 cm
Straight



SG-1204
Cuticle Nail Scissor,
Size: 9 cm, Straight



SG-1205
Fancy Scissor,
Size: 9 cm, Straight



SG-1206
Fancy Scissor,
Size: 9 cm, Straight



SG-1207
Nail Scissor, Size: 9 cm,
Straight



SG-1208
Safety Scissor, Size: 9 cm
Straight

TWEEZERS

We have 2 types of Tweezers

Precision and general tweezers

Eyebrow tweezers



SG-1251
Fine Point Tweezers for Watch makers & Eyelash Extension
Size: 10 cm, 11 cm



SG-1252
Fine Point Tweezers for Watch makers & Eyelash Extension
Size: 10 cm



SG-1253
Fine Point Tweezers for Watch makers & Eyelash Extension
Size: 10 cm



SG-1254
Fine Point Tweezers for Watch makers & Eyelash Extension
Size: 11 cm



SG-1255
X-Tweezers Cross Locking Tweezers
Size: 10 cm, 11 cm



SG-1256
Fine Point Tweezers for Watch makers & Eyelash Extension
Size: 10 cm



SG-1257
Fine Point Tweezers for Watch makers & Eyelash Extension
Size: 10.5 cm

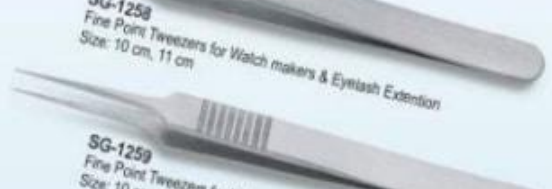

SG-1258
Fine Point Tweezers for Watch makers & Eyelash Extension
Size: 10 cm, 11 cm

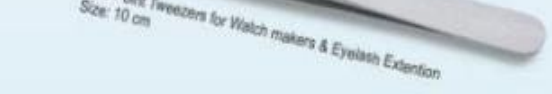

SG-1259
Fine Point Tweezers for Watch makers & Eyelash Extension
Size: 10 cm



SG-1260
Fine Point Tweezers for Watch makers & Eyelash Extension
Size: 10 cm



SG-1261
Eyebrow Tweezers (light weight) Slanted Tips
Size: 9 cm



SG-1262
Eyebrow Tweezers (light weight) Slanted Tips
Size: 9 cm



SG-1263
Eyebrow Tweezer
Size: 9 cm



SG-1264
Flat Eyebrow Tweezers
Size: 9 cm



SG-1265
Eye brow Tweezers
Size: 10 cm



SG-1266
Slant & Pointed Tip Tweezers
Size: 10 cm



SG-1267
Eyebrow Tweezers
Size: 9 cm



SG-1268
Eyebrow Tweezers
Size: 9 cm, 10 cm



SG-1269
Tweezers Slanted Tips
Size: 9 cm



SG-1270
X-Tweezers, cross locking Tweezers
Size: 10 cm



SG-1271
Eye lash Cross section Tweezers
Size: 10.5 cm



SG-1272
Eye lash Holder Tweezers
Size: 10 cm

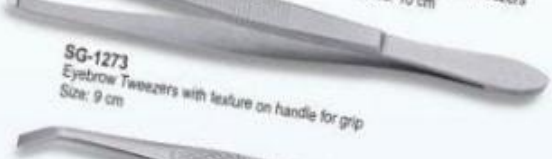

SG-1273
Eyebrow Tweezers with texture on handle for grip
Size: 9 cm



SG-1274
Eyebrow Tweezers with texture on handle for grip
Size: 9 cm

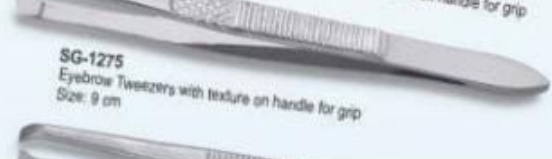

SG-1275
Eyebrow Tweezers with texture on handle for grip
Size: 9 cm



SG-1276
Eyebrow Tweezers
Size: 9 cm



SG-1277
Eyebrow Tweezers
Size: 9 cm



SG-1278
Eyebrow Tweezers with texture on handle for grip
Size: 9 cm



SG-1279
Fine Pointed Tweezers, with texture on handle for grip
Size: 9 cm



SG-1280
Eyebrow Tweezers with texture on handle for grip
Size: 9 cm



SG-1281
Tweezers straight Tips, Oval style
Size: 9 cm



SG-1282
Tweezers Slanted Tips
Size: 9 cm



SG-1283
Magnifying Tweezers Pointed Tips
Size: 10 cm



SG-1284
Magnifying Tweezers Pointed
Size: 11 cm



SG-1285
Eyebrow Tweezers
Size: 9 cm



SG-1286
Automatic Tweezers
Size: 11.5 cm



SG-1287
Automatic Tweezers
Size: 10 cm



SG-1288
Automatic Tweezers with Plastic Handle
Size: 10 cm



SG-1289
Eyelash Curler
Size: 10 cm



SG-1290
Scissors Tweezers
Size: 9 cm



SG-1291
Eyebrow Tweezers
Size: 9 cm



SG-1292
Eyebrow Tweezers
Size: 9 cm



SG-1293
Eyebrow Tweezers Gold Plated
Size: 9 cm



SG-1294
Tweezers with fine point
Size: 9 cm



SG-1295
Tweezers with fine point
Size: 9 cm



SG-1296
Double Ended Tweezers
Size: 10 cm



SG-1297
Double Ended Tweezers
Size: 10 cm



SG-1298
Double Ended Tweezers
Size: 10 cm



SG-1299
Lighting Tweezers
Size: 10 cm



SG-1300
Eyebrow Tweezer, Size: 9 cm



SG-1301
Eyebrow Tweezer, Size: 9 cm



SG-1302
Eyebrow Tweezer, Size: 9 cm



SG-1303
Eyebrow Tweezer, Size: 9 cm



SG-1304
Eyebrow Tweezer, Size: 9 cm



SG-1305
Eyebrow Tweezer, Size: 9 cm



SG-1306
Eyebrow Tweezer, Size: 9 cm



SG-1307
Eyebrow Tweezer, Size: 9 cm

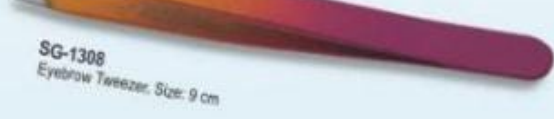

SG-1308
Eyebrow Tweezer, Size: 9 cm



SG-1309
Eyebrow Tweezer, Size: 9 cm



SG-1310
Eyebrow Tweezer, Size: 9 cm



SG-1311
Eyebrow Tweezer, Size: 9 cm



SG-1312
Eyebrow Tweezer, Size: 9 cm



SG-1313
Eyebrow Tweezer, Size: 9 cm



SG-1314
Eyebrow Tweezer, Size: 9 cm

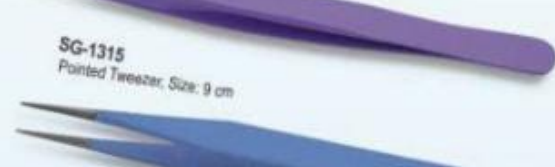

SG-1315
Pointed Tweezer, Size: 9 cm



SG-1316
Pointed Tweezer, Size: 9 cm

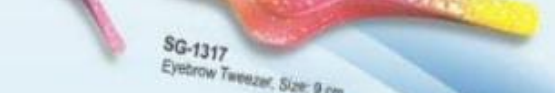

SG-1317
Eyebrow Tweezer, Size: 9 cm

MANICURE INSTRUMENTS



SG-1351
Skin care tool
Double-ended, Blackhead Remover

SG-1352
Skin care tool
Double-ended, Blackhead Remover

SG-1353
Skin care tool
Double-ended, Blackhead Remover

SG-1354
Skin care tool
Double-ended, Blackhead Remover

SG-1355
Skin care tool
Double-ended, Blackhead Remover

SG-1356
Skin care tool
Single-ended, Blackhead Remover

SG-1357
Skin care tool
Single-ended, Blackhead Remover

SG-1358
Skin care tool
Double-ended, Blackhead Remover

SG-1359
Skin care tool
Double-ended, Blackhead Remover

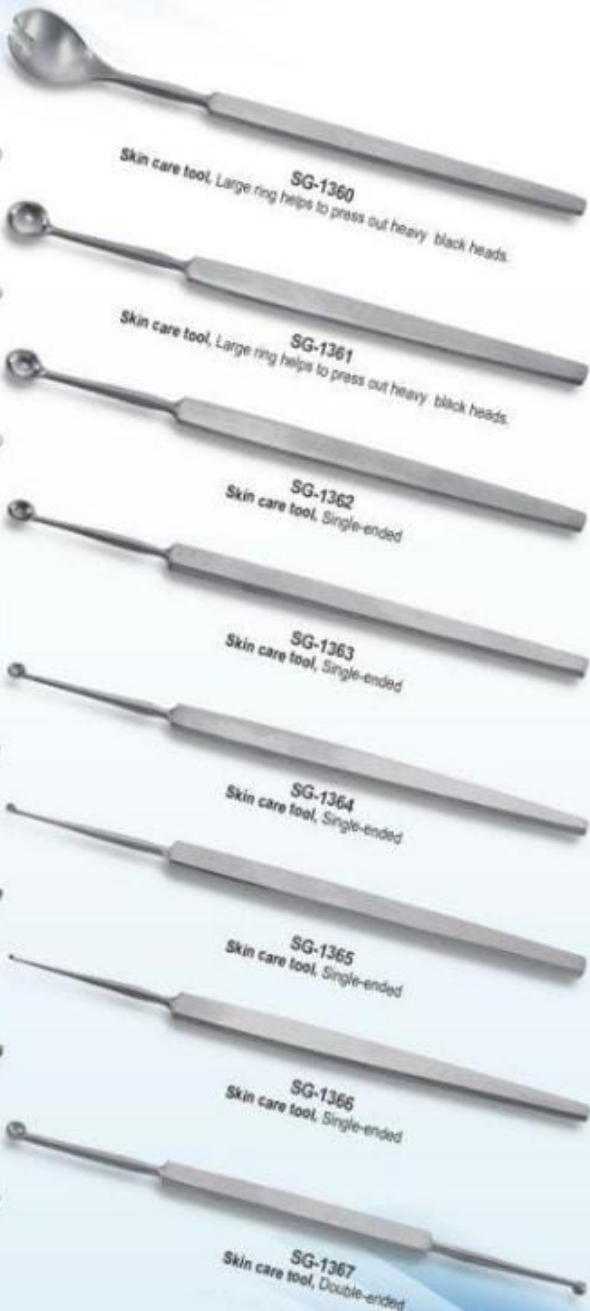

SG-1360
Skin care tool, Large ring helps to press out heavy black heads.

SG-1361
Skin care tool, Large ring helps to press out heavy black heads.

SG-1362
Skin care tool, Single-ended

SG-1363
Skin care tool, Single-ended

SG-1364
Skin care tool, Single-ended

SG-1365
Skin care tool, Single-ended

SG-1366
Skin care tool, Single-ended

SG-1367
Skin care tool, Double-ended



SG-1368
Cuticle Cutter Single ended heavy handle

SG-1369
Cuticle Pusher with Knife

SG-1370
Cuticle Pusher with Knife

SG-1371
Cuticle Pusher with Knife

SG-1372
Cuticle Pusher & Knife

SG-1373
Cuticle Pusher

SG-1374
Cuticle Knife

SG-1375
Cuticle Knife

SG-1376
Cuticle Pusher



SG-1377
Pedicure Nail Pusher Single-ended

SG-1378
Cuticle Pusher Double ended

SG-1379
Cuticle Pusher Double ended

SG-1380
Cuticle Pusher Double ended

SG-1381
Cuticle Pusher Double ended

SG-1382
Cuticle Pusher Double ended

SG-1383
Cuticle Pusher Double ended

SG-1384
Cuticle Pusher Double ended (Perfect for Fingers & Toe nails)

SG-1385
Pterygium Remover



SG-1386
Cuticle Pusher, Double ended



SG-1387
Cuticle Pusher & Pterygium Remover



SG-1388
Cuticle Pusher & Knife



SG-1389
Cuticle & Nail Pusher 10 cm

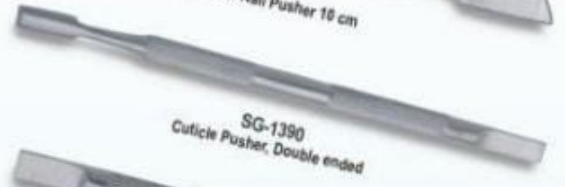

SG-1390
Cuticle Pusher, Double ended



SG-1391
Cuticle Pusher, Double ended



SG-1392
Cuticle Pusher, Double ended



SG-1393
Cuticle Pusher-Top quality Double ended
Pusher knurled body prevents slipping



SG-1394
Multi Purpose Pusher



SG-1395
Lecrón



SG-1396
Nail File



SG-1397
Cuticle Pusher & Knife



SG-1398
Cuticle Pusher, Single ended



SG-1399
Nail File



SG-1400
Nail File



SG-1401
Nail File



SG-1402
Skin care tool

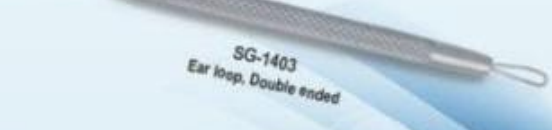

SG-1403
Ear loop, Double ended



SG-1404
Blackhead remover, Double ended



SG-1405
Comedone Extractor / Lance with steel protective cover



SG-1406
Skin care tools



SG-1407
Skin care tool



SG-1408
Needle Holder



SG-1409
Cuticle Pusher & Trimmer



SG-1410
V Cuticle Trimmer



SG-1411
Spatula, Double ended, Stainless steel

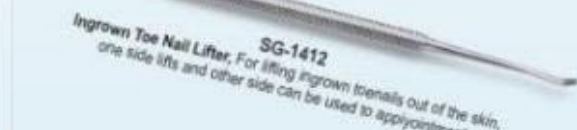

SG-1412
Ingrown Toe Nail Lifter, For lifting ingrown toenails out of the skin,
one side lifts and other side can be used to appointment



SG-1413
Cuticle Pusher, Double ended



SG-1414
Extractor style nail cleaning tool



SG-1415
Skin care tool



SG-1416
Nail cleaning & nail file



SG-1417
Manicure pick, single ended, half moon curve



SG-1418
Nail file coarse

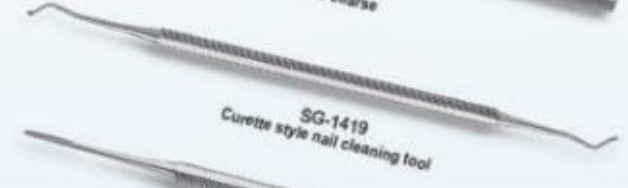

SG-1419
Curette style nail cleaning tool



SG-1420
Ingrown nail file

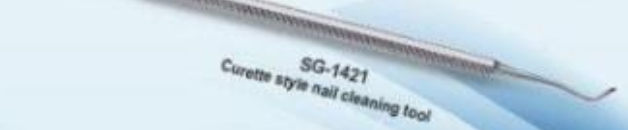

SG-1421
Curette style nail cleaning tool



SG-1386
Cuticle Pusher, Double ended



SG-1387
Cuticle Pusher & Pterygium Remover



SG-1388
Cuticle Pusher & Knife



SG-1389
Cuticle & Nail Pusher 18 cm

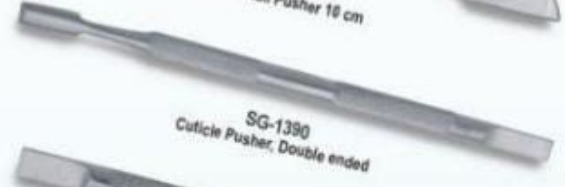

SG-1390
Cuticle Pusher, Double ended



SG-1391
Cuticle Pusher, Double ended



SG-1392
Cuticle Pusher, Double ended

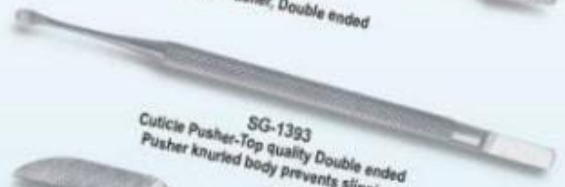

SG-1393
Cuticle Pusher-Top quality Double ended
Pusher knurled body prevents slipping



SG-1394
Multi Purpose Pusher



SG-1395
Lecron



SG-1396
Nail File



SG-1397
Cuticle Pusher & Knife



SG-1398
Cuticle Pusher, Single ended



SG-1399
Nail File



SG-1400
Nail File



SG-1401
Nail File



SG-1402
Skin care tool

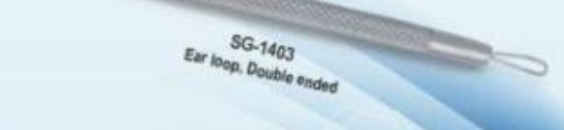

SG-1403
Ear loop, Double ended



SG-1422
Extractor & Point



SG-1423
Blackhead remover Double ended



SG-1424
Pterygium remover 6"



SG-1425
Skin care tool



SG-1426
Blade Holder



SG-1427
Blade Holder

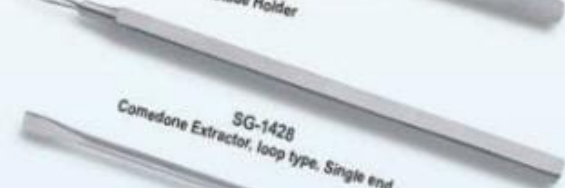

SG-1428
Comedone Extractor, loop type, Single end

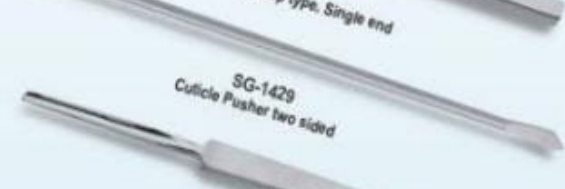

SG-1429
Cuticle Pusher two sided



SG-1430
Cuticle Pusher Single ended



SG-1431
Blackhead remover Double ended



SG-1432
Cuticle Knife



SG-1433
Cuticle Remover
11.5 cm



SG-1434
Cuticle Pusher, Single ended



SG-1435
Cuticle Pusher, Double ended
5mm, 9mm



SG-1436
Spatula Knife



SG-1437
Professional Nail Pusher
with 4 different attachments

CUTICLE NAIL
NIPPERS &
CUTTERS



SG-1451
Professional Cuticle Nipper
double spring, 11cm
Box Joint
Tip Size: 4, 6, 8 mm



SG-1452
Professional Cuticle Nipper
Single Spring, 10 cm
Box Joint
Tip Size: 4, 6, 8 mm



SG-1453
Professional Cuticle Nipper
double spring, 11cm
Box Joint
Tip Size: 4, 6, 8 mm



SG-1454
Professional Cuticle Nipper
single spring, 10 cm
Box Joint
Tip Size: 4, 6, 8, 10 mm



SG-1455
Professional Cuticle Nipper
Roller spring, 10cm
Box Joint
Tip Size: 4, 6, 8 mm



SG-1456
Professional Cuticle Nipper
Double Spring, 10 cm
Box Joint
Tip Size: 4, 6, 8 mm



SG-1457
Russian style professional
Acrylic Nipper double spring
12 cm . Lap Joint
Tip Size: 4, 6, 8, 10 mm



SG-1458
Professional Cuticle Nipper
Double Spring, 11 cm
Box Joint
Tip Size: 4, 6, 8 mm



SG-1459
Cuticle Nipper Square handle
10cm , Box Joint
Tip Size: 4, 6, 8 mm



SG-1460
Professional Cuticle Nipper
double spring, 11cm
Lap Joint
Tip Size: 4, 6, 8 mm



SG-1461
Professional Cuticle Nipper
Single Spring , 10 cm
Lap Joint
Tip Size: 4, 6, 8, 10 mm



SG-1462
Professional Cuticle Nipper
Single Spring, 10 cm
Box Joint
Tip Size: 4, 6, 8 mm



SG-1463
Professional Cuticle Nipper
Double Spring , 10 cm
Box Joint
Tip Size: 4, 6, 8, 10 mm



SG-1464
Professional Cuticle
Nipper double Dpring, 10 cm
Box Joint
Tip Size: 4, 6, 8 mm



SG-1465
Professional Cuticle
Nipper Barrel Spring, 10 cm
Lap Joint
Tip Size: 4, 6, 8 mm



SG-1466
Cuticle Nipper
Tweezer Handle, 10 cm
Lap Joint, Tip Size: 4, 6, 8 mm



SG-1467
Professional Cuticle Nipper
Double Spring, 12 cm
Lap Joint
Tip Size: 4, 6, 8 mm



SG-1468
Cuticle Nipper
Scissors Handle, 10 cm
Box Joint
Tip Size: 4, 6, 8 mm



SG-1469
Professional Nail Cutter
Double Spring with Lock
Full Moon Heavy Duty
Box Joint, Size: 14 cm



SG-1470
Professional Nail Cutter
Double Spring with Lock
Half Moon Heavy Duty
Box Joint, Size: 16 cm



SG-1471
Professional Nail Cutter
Double Spring
Size: 14 cm
Lap Joint



SG-1472
Professional Nail Cutter
Scissor Handle
Size: 14 cm
Box Joint



SG-1473
Professional Nail Cutter
Double Spring with Lock
Size: 12 cm
Box Joint



SG-1474
Professional Nail Cutter
Double Spring with Lock
Size: 12 cm
Box Joint



SG-1475
Professional Nail Cutter
Double Spring with Lock
Size: 12 cm
Box Joint



SG-1476
Professional Nail Cutter
Double Spring with Lock
Size: 13 cm
Box Joint



SG-1477
Professional Nail Cutter
Double Spring with Lock
Size: 13 cm
Box Joint



SG-1478
Professional Nail Cutter
Double Spring
Size: 12 cm
Box Joint



SG-1479
Professional Toe Nail Cutter
Double Spring
Size: 11 cm, 12 cm, 13 cm
Box Joint



SG-1480
Nail Cutter, Wire Spring
Size: 11 cm
Lap Joint



SG-1481
Nail Cutter
Double Spring
Size: 12 cm
Lap Joint



SG-1482
Nail Cutter, Wire Spring
Round Box
Size: 12 cm
Lap Joint



SG-1483
Ingrown Nail Cutter
Double Spring
Size: 12 cm
Box Joint



SG-1484
Nail Corner Cutter
Double Spring
Size: 10 cm, 11 cm, 12 cm
Box Joint



SG-1485
Professional Nail Cutter
Double Spring
Size: 11 cm, 12 cm, 13 cm
Box Joint



SG-1486
Ingrown Nail Cutter
Double Spring
Size: 12 cm
Box Joint



SG-1487
Ingrown Nail Cutter
Double Spring
Size: 12 cm
Box Joint



SG-1488
Nail Cutter Barrel
Spring with Lock
Size: 12 cm
Lap Joint



Titanium Coated Multicolor Coated



SG-1489
Animal Nail Cutter
Barrel Spring with Lock
Size: 14 cm
Lap Joint



SG-1490
Centerfile / Podiatrist
Nail Cutter, Barrel Spring
with lock Double Action
Size: 16 cm
Lap Joint



SG-1491
Centerfile / Podiatrist
Nail Cutter, Barrel Spring
with lock Double Action
Size: 16 cm
Lap Joint



SG-1492
Professional Toe Nail Nipper
Double Spring Double Action
Size: 16 cm



Titanium Coated Multicolor Coated

NAIL FILES,
FOOT FILES &
FOOT RASPS



SG-1501
Dixelone File
20 cm

SG-1502
Ten Nail File
20 cm

SG-1503
Ten Nail File
20 cm

SG-1504
Nail File
20 cm

SG-1505
Dixelone File
15 cm



SG-1506
Nail File
9 cm

SG-1507
Nail File
9 cm

SG-1508
Nail File
5 cm

SG-1509
Nail File
17.5

SG-1510
Nail File

SG-1511
Cuticle Pusher

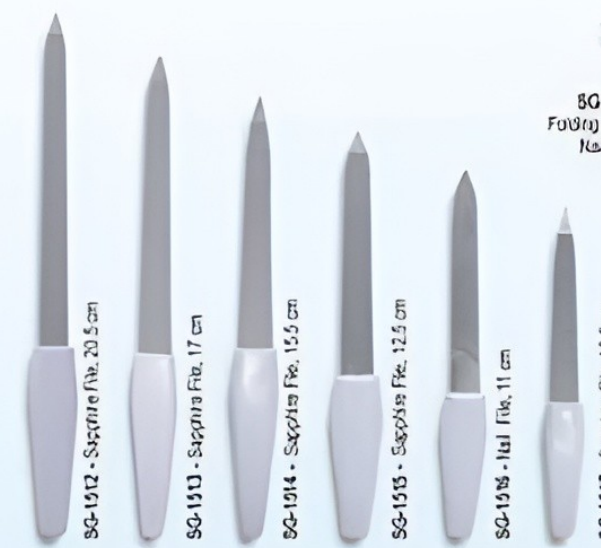

SG-1512 - Sapporo File, 20.5 cm

SG-1513 - Sapporo File, 17 cm

SG-1514 - Sapporo File, 15.5 cm

SG-1515 - Sapporo File, 12.5 cm

SG-1516 - Nail File, 11 cm

SG-1517 - Sapporo File, 10.5 cm

SG-1610
Folding Scissors
Nail File



SG-1610
Folding Scissors



SG-1620
Nail Scissor
18 cm

SG-1621
Nail Scissor
10 cm

SG-1622
Nail Scissor
10 cm



SG-1551
Foot file / cuticle Pusher
Plastic Handle

SG-1552
Foot file / cuticle Pusher
Plastic Handle

SG-1553
Foot file / cuticle Pusher
Plastic Handle

SG-1554
Foot file / cuticle Pusher
Plastic Handle

SG-1555
Cuticle Pusher
Cuticle Pusher
Cuticle Pusher
Cuticle Pusher
Cuticle Pusher
Cuticle Pusher

SG-1556
Cuticle Pusher
Cuticle Pusher
Cuticle Pusher
Cuticle Pusher
Cuticle Pusher
Cuticle Pusher



SG-1657
Sapporo nail file

SG-1658
Sapporo nail file
12.5 cm

SG-1659
Foot file / cuticle Pusher
Plastic Handle

SG-1660
Foot file / cuticle Pusher
Plastic Handle

SG-1661
Foot file / cuticle Pusher
Plastic Handle

SG-1662
Cuticle Pusher
Cuticle Pusher

SG-1663
Foot file / cuticle Pusher
Plastic Handle

SG-1664
Foot file / cuticle Pusher
Plastic Handle



SG-1575 Corn Cutter פורטו חרטה
SG-1576 Corn Cutter פורטו חרטה
SG-1577 Corn Cutter פורטו חרטה
SG-1578 Corn Cutter פורטו חרטה
SG-1579 Corn Cutter מיל חרטה
SG-1580 Corn Cutter מיל חרטה
SG-1581 Corn Cutter מיל חרטה
SG-1582 Corn Cutter מיל חרטה
SG-1583 Corn Cutter מיל חרטה
SG-1584 Corn Cutter סטראן חרטה



SG-1591 Acrylic To Cutter סטראן חרטה סייז 5"
SG-1592 Acrylic To Cutter סטראן חרטה סייז 5"
SG-1593 Acrylic To Cutter סטראן חרטה סייז 5"
SG-1594 Acrylic To Cutter סטראן חרטה סייז 5"

SG-1597
 Toe Nail Cutter
 פורטו חרטה
 (פורטו חרטה)



SG-1598
 Toe Nail Cutter
 (פורטו חרטה)



SG-1599
 Toe Nail Cutter
 (פורטו חרטה)



SG-1600



SG-1603
 Acrylic To Cutter
 סטראן חרטה סייז 5"



SG-1604
 Acrylic To Cutter
 סטראן חרטה סייז 5"



SG-1601
Razor plastic handle
with disposable blade

SG-1602
Razor plastic handle
with disposable blade

SG-1603
Razor Stainless Steel
with disposable blade

SG-1604
Razor plastic handle
with disposable blade

SG-1605
Razor Stainless Steel
with disposable blade

SG-1606
Razor plastic handle
with disposable blade



SG-1607
Disposable Razor

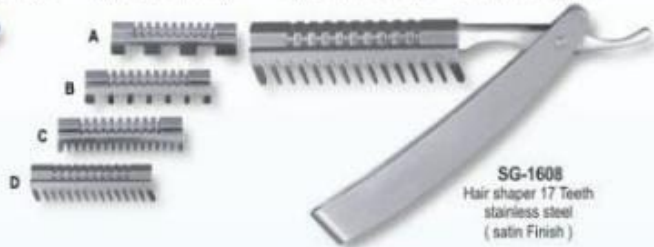

SG-1608
Hair shaper 17 Teeth
stainless steel
(satin Finish)

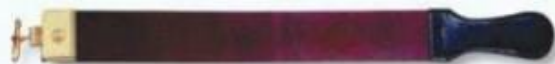

SG-1609
Leather sharpener



SG-1610
Leather sharpener



SG-1611
Hair Shaper

SG-1612
Hair Shaper with
Plastic Handle, 17 Teeth

SG-1613
Hair Shaper

SG-1614
Hair Shaper

SG-1615
Hair Shaper

SG-1616
Hair Shaper
with Scissor Handle



SG-1617
Hair Shaper

SG-1618
Shaving Cup

SG-1619
Shaving Cup

RAZORS & ACCESSORIES

TAILOR SCISSORS



SG-1631
Tailor Scissor
Size: 7", 8", 9", 10", 11", 12"



SG-1632
Trimmer Shears
Size: 7", 8", 9", 10", 11", 12"



SG-1633
House hold Scissors
Size: 6", 7", 8"



SG-1634
House hold Scissors
Size: 5", 6", 7", 8"



SG-1635
Paper and house
hold Scissors
Size: 7.5"



SG-1641
School Scissor With
Plastic Handle. Size: 4.5"



SG-1642
Light Weight Plastic
Handle Scissors. Size: 6.5"



SG-1643
Light Weight Plastic
Handle Tailor Scissor. Size: 7"



SG-1644
Utility Scissor
size: 5.5" / 7.25"



SG-1645
School Baby
Scissor. Size: 5"



SG-1646
Electric Wire Scissor with



SG-1651
Hair Extension Plier

SG-1652
Hair Extension Plier



SG-1658
Hair Extension Plier

SG-1659
Hair Extension Plier



SG-1653
Hair Extension Plier

SG-1654
Hair Extension Plier



SG-1660
Hair Extension Plier



SG-1655
Hair Extension Plier
with Plastic handle



SG-1661
Hair Extension Plier

SG-1662
Hair Extension Plier



SG-1656
Hair Extension Plier
with Plastic handle



SG-1663
Hair Extension Loops

SG-1664
Hair Extension Loops

SG-1657
Hair Extension Plier Kit



SG-1665
Hair Extension Kit
Set of 4 Pcs



SG-1666
Hair Extension Kit
Set of 3 Pcs



SG-1667
Hair Extension Kit
Set of 3 Pcs



SG-1668
Hair Extension Kit
Set of 3 Pcs

HAIR EXTENSION PLIERS

MANICURE/
PEDICURE
INSTRUMENTS



SG-1681
Manicure Instruments Kit
Set of 7 Pcs



SG-1682
Manicure Instruments Kit
Set of 5 Pcs



SG-1683
Manicure Instruments Kit
Set of 5 Pcs



SG-1684
Manicure Instruments Kit
Set of 6 Pcs



SG-1685
Manicure Instruments Kit
Set of 6 Pcs



SG-1686
Manicure Instruments Kit
Set of 6 Pcs



SG-1687
Manicure Instruments Kit
Set of 9 Pcs



SG-1688
Manicure Instruments Kit
Set of 12 Pcs



SG-1689
Manicure Instruments Kit
Set of 5 Pcs



SG-1690
Manicure Instruments Kit
Set of 6 Pcs



SG-1691
Manicure Instruments Kit
for 5 Instruments



SG-1692
Manicure Instruments Kit
for 11 Instruments



SG-1693
Manicure Instruments Kit
for 5 Instruments



SG-1694
Manicure Instruments Kit
for 6 Instruments



SG-1695
Manicure
Instruments
Pouch



SG-1696
Manicure
Instruments
Pouch



SG-1697
Tweezer
Blister box
Packing



SG-1698
Tweezer
Blister box
Packing



SG-1699
Nail Cutter
Blister box
Packing



SG-1700
Nail Nipper
Blister box
Packing



SG-1701
Nail Scissor
Blister box
Packing



SG-1702
Nail Scissor
Blister Packing



SG-1703
Razor Scissor
Blister Packing



SG-1704
Nail Nipper
Blister Packing



SG-1705
Nail Cutter
Blister Packing



SG-1706
Eyebrow Tweezer
Blister Packing



SG-1707
Manicure
instruments
Pouch



SG-1708
Manicure
instruments
Pouch



SG-1709
Manicure
instruments
Pouch



SG-1710
Hair Cutting Scissor Kit
Set of 1 Pcs



SG-1711
Hair Cutting & Thinning
Scissor Kit
Set of 2 Pcs



SG-1712
Nail Nipper & Cutter
Kit. Set of 1 Pcs



SG-1713
Manicure Instruments
Pouch



SG-1714
Cuticle Nail Scissor
Pouch



SG-1715
Barber Razor
Pouch



SG-1716
Cuticle Nail Scissor Pouch
Set of 1 Pcs



SG-1717
Manicure Instruments Kit
Set of 6 Pcs



SG-1718
Hair Cutting Scissors Kit
Set of 6 Pcs



SG-1719
Hair Cutting Scissors Kit



SG-1720
Hair Cutting Scissors Kit
Set of 2 Pcs



THANK YOU



SURGIPROVE

SURGICAL SUPPLIERS

*SINGLE USE
INSTRUMENTS*



FM-S - 7001
Rampley Forceps
180mm (7")
240mm (9.1/2")



FM-S - 7002
Schroeder Forceps
230mm (9")



FM-S - 7003
Babcock Forceps
165mm (6.1/2")
200mm (8")
230mm (9")



FM-S - 7004
Sinus Forceps
125mm (5")
150mm (6")
180mm (7")



FM-S - 7005
Needle Holder (Crile Wood)
150mm (6")
160mm (6.1/4")
180mm (7")
200mm (8")



FM-S - 7006
Mixer Forceps
220mm (8.3/4")
250mm (10")



FM-S - 7007
Sponge Forceps
180mm (7")
240mm (9.1/2")



FM-S - 3144 STR
FM-S - 4144 CVD
Surgical Scissors 140 mm
B/B

FM-S - 3244 STR
FM-S - 4244 CVD
Surgical Scissors 140 mm
Sh/B

FM-S



FM-S - 1066 STR
FM-S - 1077 CVD
Iris Scissors 115 mm



FM-S - 1000 STR
FM-S - 1011 CVD
Delicate Scissors 90 mm



Braun - Stadler
FM-S - 1400 140 mm
FM-S - 1411 200 mm

Liator Bangege Scissors
FM-S - 8611 140 mm
FM-S - 8622 180 mm
FM-S - 8633 200 mm



FM-S - 6011 STR
FM-S - 6055 CVD
Metzgerbaum Distorting Scissors 14 cm

FM-S - 2044
Dorf Needle Holders 125 mm



FM-S - 4822
Noyes Eye Scissors 125 mm



Mayo Hegar Needle Holders
 FM-S - 2355/1 140 mm
 FM-S - 2355 150 mm
 FM-S - 2200 160 mm
 FM-S - 2366 180 mm
 FM-S - 2377 200 mm



FM-S - 1110 STR
FM-S - 1111 CVD
 Halsted Mosquito Artery Forceps
 12.5 mm



Kocher Artery Forceps
 FM-S - 6144 STR 140 mm
 FM-S - 6155 CVD 140 mm
 FM-S - 6300 STR 150 mm
 FM-S - 6310 CVD 150 mm



FM-S - 0677
 Weitlaner Retractors 130 mm
 Semi Sharp



FM-S - 0766
 Micro Needle Holders STR
 with out Catch 180 mm



FM-S - 7000
 Adson Brown Forceps
 120 mm



FM-S - 5111
 Adson Tissue Forceps
 120 mm 1x2 Tooth



FM-S - 2222
 Adson Dissecting Forceps
 120 mm

Pean Hemostatic Forceps
 FM-S - 4244 STR 140 mm
 FM-S - 4255 CVD 140 mm
 FM-S - 4222 STR 160 mm
 FM-S - 4233 CVD 160 mm
 FM-S - 4444 STR 185 mm
 FM-S - 4255 CVD 185 mm
 FM-S - 4266 STR 200 mm
 FM-S - 4277 CVD 200 mm



FM-S - 0477
 Dissecting Forceps
 Standard 140 mm

FM-S - 2390
 Dissecting Forceps
 Cushing 200 mm



FM-S - 0277
 Dissecting Forceps
 Medium 140 mm



FM-S - 4111
 Doboyek Atraumatic
 Dissecting Forceps
 150 mm



FM-S - 6711
 Tissue Forceps
 Waugh 200 mm
 1x2 Tooth



FM-S - 5577
 Dissecting Forceps
 Standard 140 mm
 1x2 Tooth



FM-S - 0088
 Sonn Miller Retractors 165 mm
 10 x 5.5 mm



FM-S - 9644
 Feilchenfid 95 mm



FM-S - 0288
 Roux Retractor 170 mm



FM-S - 6688
 Willger Curettes



FM-S - 8500
 Bone Curettes
 Double Ended



FM-S - 8466
 Bone Curettes
 Double Ended
 160 mm



Single Use Dissecting Kit 6 PCS

THANK YOU



SURGI PROVE

www.surgiprove.com



surgiprove@gmail.com



+923307020002



SURGIPROVE
SURGICAL SUPPLIERS
VETERINARY

SURGICAL INSTRUMENTS

40-276-25
Measuring Jug 2 Ltr.



40-276-26
Measuring Jug 1 Ltr.



40-276-27
Measuring Jug 1/2 Ltr.



40-276-28
Instruments Box
10" x 8" x 2"
12" x 10" x 2"
14" x 12" x 2"



40-276-29
Kidney Tray
150 mm
200 mm
240 mm
300 mm



40-276-30
Bowl
2", 3", 4", 5", 6",
8", 10", 14"

SURGICAL INSTRUMENTS



40-278-26
Barber Scissors
Curved



40-279-26
Barber Scissors
Curved with Tip



40-280-26
Trimming Scissors
Curved



40-281-26
Trimming Scissors
Curved



40-282-26
Sharp Scissors
with Plastic Handle



40-283-26
Universal Scissors



40-284-26
Barber Scissors
Straight



40-285-26
Trimming Scissors



40-286-26
Sharp Scissors 8"



40-287-26
Sharp Scissors 7"



40-288-26
Moon Scissors 7"



40-289-26
Moon Scissors
7", 8", 9"

SURGICAL INSTRUMENTS

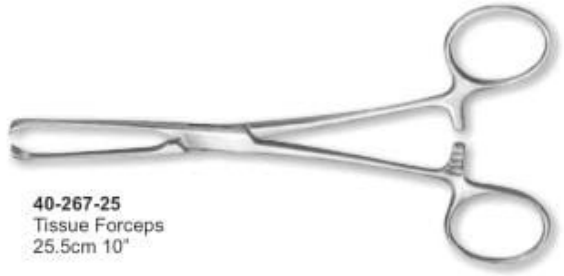

40-267-25
Tissue Forceps
25.5cm 10"

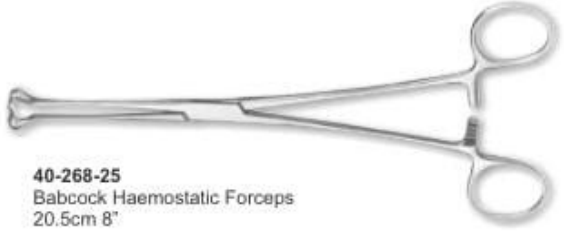

40-268-25
Babcock Haemostatic Forceps
20.5cm 8"



40-268-25
Weingart Vulsellum Forceps
24cm



40-270-25
Retractor For Caponizing
19cm



40-271-25
Seutin Plaster Shear
19cm



40-272-25
Jones
5.5cm



40-273-25
Scalpel
3



40-274-25
Scalpel
4



40-275-25
Foldable Scalpel Handle



40-277-25
Instruments Kit of 8 Pcs.

SURGICAL INSTRUMENTS



40-255-24
Kocher Forceps
with teeth
14.5cm



40-262-24
Haemostatic Forceps
25cm 9 3/4"



40-256-24
Pean (Rochester)
14.5cm



40-263-24
Haemostatic Forceps
14cm (T-Shaped)



Haemostatic Forceps
Pean
40-257-24 14.5cm 5 3/4"
40-257-24 16cm 6 1/4"



40-264-24
Foerster
Sponge Forceps
25cm 9 3/4"



40-258-24
Leriche Forceps
15.5cm



40-265-24
Haemostatic
Sponge Forceps
25cm 9 3/4"



Halsted-Mosquito
40-259-24 12.5cm str.
40-260-24 14.5cm str.
40-261-24 12.5cm cvd.
40-262-24 14.5cm cvd.



40-266-24
Backhaus Towel Forceps
16.5cm

SURGICAL INSTRUMENTS

40-243-23
Young Tongue Forceps
with Rubber Pads



40-244-23
Baby Tongue Forceps
with Rubber Pads



40-245-23
Doyen Intestinal
Clamp, 23cm



40-246-23
Crile-Wood
Needle Holder, 15cm

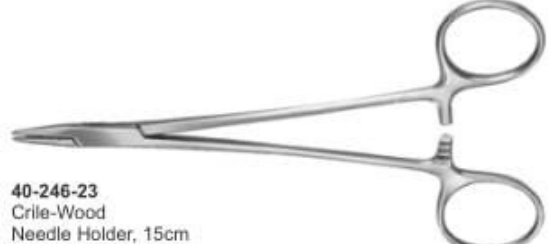

40-247-23
Gillies
16cm



40-248-23
Olsen Hegar
Needle Holder



40-249-23
Halstead Forceps
13cm

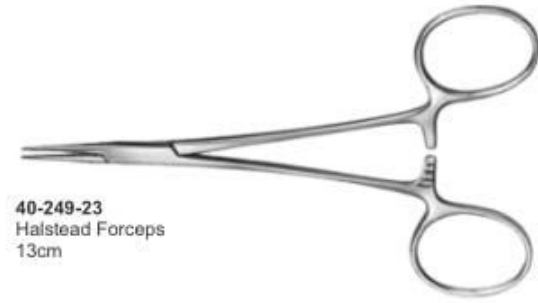

40-250-23
Hartmann Forceps, 14cm



40-252-23
Splinter Forceps
12.5cm



40-253-23
Dissecting Forceps
13cm



40-254-23
Troeltsch (Wilde)
Ear Forceps
10.5cm 4 1/8"



SURGICAL INSTRUMENTS

40-232-22
Backhaus Towel Forceps



40-233-22
Haemostatic Forceps
T-shaped, 16cm



40-234-22
Metzemaum Scissors



40-235-22
Mayo Scissors



40-237-22
Weitlaner Retractor

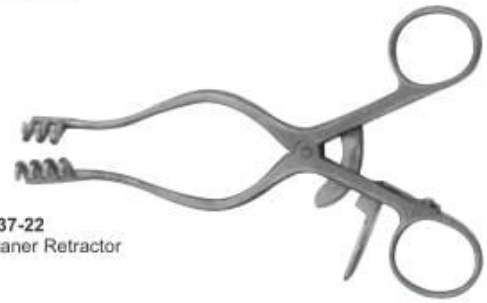

40-238-22
Forceps



40-239-22
Mathieu Needle Holder



40-240-22
Mathieu Needle
Holder Tungstene Jaws



40-241-22
Olsen Hegar Needle
Holder Tungstene Jaws

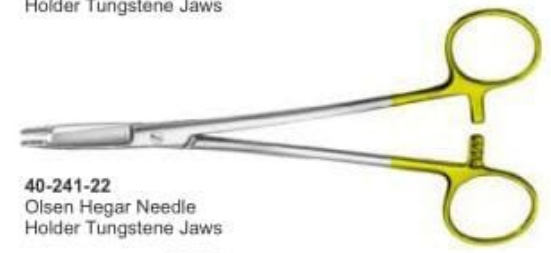

40-242-22
Gynecological Instruments



40-242-22A
Polansky Vaginal Speculum
with 3 Blades Has butterfly screws
with two blades on top.



40-242-22B
Killian Vaginal Speculum
for Dogs Has set screw and
3 1/2" blades.



SURGICAL INSTRUMENTS



40-221-21
Operating Scissors
5.5", 6", 7", 8"



40-226-21
Neurosurgical Scissors
Stullly
22.5cm 8 3/4"



40-222-21
Operating Scissors
5.5", 6", 7", 8"



40-227-21
Enterotomy Scissors
21.5cm 8 1/2"



40-224-21
Iris Scissors
10cm 4"



40-228-21
Stitch Scissors
Spencer
9cm 3 1/2"



40-225-21
Lexer-Baby
10cm 10 1/4"



40-229-21
Stitch Scissors
Spencer
13cm 5"



40-230-21
Vascular Scissors
12cm 4 3/4"

SNAKE CATCHERS



40-220-26
Snake Holder Stick
(Available in any Colours)



40-220-36
Snake Holder Stick
(Available in any Colours)



40-220-28
Snake Holder Stick
(Available in any Colours)



40-220-30
Snake Holder Stick
(Available in any Colours)



40-220-32
Snake Holder Stick
(Available in any Colours)

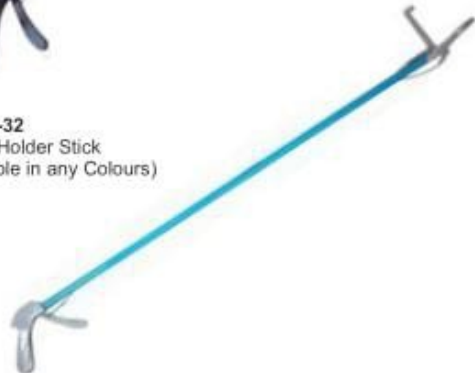

40-220-34
Snake Holder Stick
(Available in any Colours)



NAIL CUTTERS



40-211-20
Professional Toe Nail Nipper 16cm
Compound Action,
Stainless Steel (Satin finish)



40-212-20
Professional Toe Nail Nipper 16cm
Compound Action, Stainless Steel
(Satin finish)



40-213-20
Professional Toe
Nail Nipper



40-214-20
Professional Toe
Nail Nipper



40-215-20
Toe Nail Nipper 14cm
Box Joint, Double Spring
Stainless Steel (Satin finish)



40-216-20
Professional Toe Nail
Nipper 16cm Double Action,
Stainless Steel (Satin finish)



40-217-20
Professional Toe
Nail Nipper



40-218-20
Professional Toe
Nail Nipper



40-219-20
Nail Profiler (with grip)
14.5cm, Stainless Steel (Powder coated)



40-220-20
Nail Profiler 14.5cm
Stainless Steel



40-220-22



40-220-24



STOMIC TUBE & MAGNETS



40-210-24
Wolf Tooth Elevator / Extractor
They come in a set of two or can be purchased individually, each head is made of surgical stainless steel and each handle made with lightweight aluminum, both are made to precise measurements and standards of our company, heads come in two diameters 5/8" and 3/8"



40-210-26
Cow Magnet
1/2" x 3" Long
This Not-toxic, non-corrosive, cow magnet is the pinnacle of what the industry has come to expect, made of the highest grade materials, this magnet has been the choice of many dairymen and veterinarians over the years, wt 3.0 oz.



40-210-30
Stomach Flexible Tube
6 Feet



40-210-32
Saw Handle



40-210-34
Catheter (Female)



40-210-36
Catheter (male)



BALLING GUNS



40-210-20



40-210-24



40-210-22



40-210-28



40-210-26



40-210-32



40-210-30



40-196-19
Stomach Pump



40-197-19
Stomach Pump



40-198-19
Balling Gun, Upto 6 Boluses
Can Be Administrated Per Animal,
Pistol Grip Handle



40-200-19
Balling Gun with Metal Head
with or without Spring



40-201-19
Balling Gun with Rubber
Head with or without spring



40-202-19
Balling Gun with Plastic
Head with or without spring



40-203-19
Balling Gun with Metal
Head with or without spring



40-204-19
Syringe



40-205-19
Syringe



40-206-19
Syringe with Plastic Handle



40-207-19
Revolver Syringe, Heavy Duty
Syringes with Metallic Body &
Glass Barrel Available in
10ml, 30ml, 50ml



40-208-19
Revolver Syringe, Heavy Duty
Syringes with Metallic Body &
Glass Barrel Available in
10ml, 30ml, 50ml



40-209-19
Syringe



40-210-19
Revolver Syringe
Cover Leather

BALLING GUNS



HORSE DENTAL



40-188-18
Tooth Forceps



40-189-18
Scalar



40-190-18
Elevator



40-191-18
Small Elevator



40-192-18
Left Elevator
3mm Head



40-193-18
Straight Elevator
3mm Head



40-194-18
Right Elevator
3mm Head

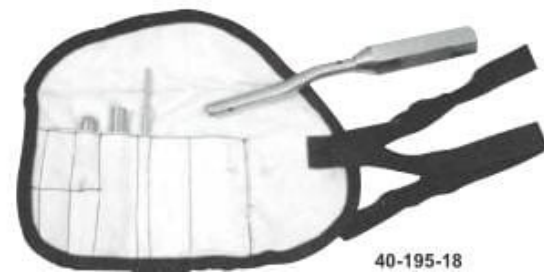

40-195-18



40-182-18
Tooth Forceps



40-183-18
Tooth Forceps



40-184-18
Single Joint
Rongeur 7" s/s



40-185-18
Compound Rongeur



40-186-18
Tooth Forceps



40-171-17
Mouth Speculum Haussmann
Model with Leather Straps,
or Nylon Straps



40-172-17
Tooth Float set



40-173-17
Reynold Style Cap
Extractors, 17" s/s



40-174-17
Simple Joint Stainless
Steel Molar Spreader



40-175-17
Simple Joint Stainless
Steel Molar Forceps



40-176-17
Cap Incisor



40-177-17
Molar Extractors,
s/s 15"



40-178-17
Incisor & Canine Cutter
s/s, 10"



40-179-17
Incisor Forceps, 10"



40-180-17
Liautard Style
Forceps 10" S.S



40-181-17
Incisor Cap and Wolf
Tooth Forceps, 7" S.S

HORSE DENTAL



MILK SUCKING PREVENTOR

40-163-16
Milk Sucking Preventor with Spring Made of Aluminium & Having 2 Models with or without Spikes



40-167-16
Spiked Swingarm Milk Sucking Preventors Made of Metal With Adjustment Nut



40-168-16
French Style Milk Sucking Preventors



40-164-16
Plastic Milk Sucking Preventor With Different Colours With Different Sizes



40-169-16

40-165-16
French Style Milk Sucking Preventors Mini, Sml, Med, Lrg



40-166-16
French Style Milk Sucking Preventors Mini, Sml, Med, Lrg



40-170-16
Mouth Speculum with leather straps



ANTI KICK INSTRUMENTS



40-155-15
Anti Kick Clamp



40-156-15
Anti Kick Clamp



40-157-15
Anti Kick Bar Spring
For Anti Kick Bar



40-158-15
Anti Kick Bar Spring
For Anti Kick Bar



40-159-15



40-160-01



40-160-02



40-160-03



40-160-04



40-160-15
Sheep Cuff

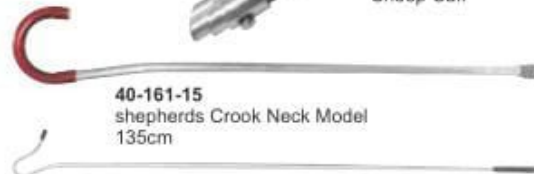

40-161-15
shepherds Crook Neck Model
135cm



40-162-15
shepherds Crook Leg Model
95cm



40-153-12



40-153-09



40-153-13



40-153-10
Tag Puncher



40-153-14
O.B Handle S.S



40-153-11



40-154-14
Eye Hook S.S

ANTI KICK FORCEPS



EAR NOTCHER



40-149-14
Tattooing Forceps
(E)



40-150-10



40-150-11



40-150-12



40-150-13



40-150-14
Trocars - A - with Plastic Handle



40-151-14
Trocars - B - S.S



40-151-14



40-152-15



40-152-16



40-152-17



40-152-18



40-152-19



40-145-13
Ear Notcher - A-type



40-140-14



40-146-14
Tattooing Forceps
(A)



40-147-14
Tattooing Forceps
(B)



40-148-14
Tattooing Forceps
(C), (D)



40-140-13
Ear Notcher S.S
Design in the Center
of the ear

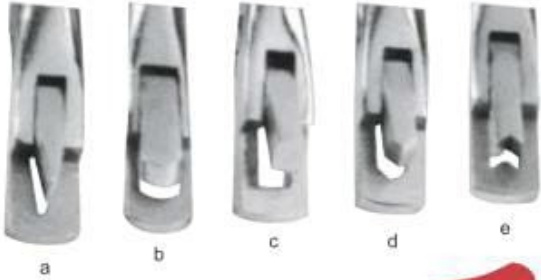

40-143-13
Tag Applicator Plier



40-144-13
Ear Notcher
with lock

EAR

NOTCHER

SNATCHERS & OBSTETRICAL



40-127-12
Pig Catcher



40-128-12
Aluminum Mini
Hog Catcher



40-129-12
Calf Puller



40-130-12
Calving Assist
Forceps S.S



40-131-12
Obstetric Forceps For
Pig About 52cm Long, S.S



40-132-12
Obstetric Chain 30", S.S or N.P



40-133-12
Obstetric Chain
60", S.S or N.P



40-134-12
Lambing Aid Plastic



40-135-12
Wire Handle



40-136-12
Wire Handle

SNATCHERS



40-116-11
Mini Hog Catcher
Rubber Grips



40-117-11
Pig Holder S.S



40-118-11
Pig Holder S.S



40-119-11
Hog Catcher with
Rubber Grips



40-120-11
Pig Catcher



40-121-11
Calf Head Snare



40-121-11



40-122-11



40-122-11



40-122-11



40-123-11
Balling Gun with Plastic Head
with or without spring



40-124-11
Calving Forceps, S.S



40-125-11
Pig Catcher S.S



40-126-11
Pig Catcher
with Plastic Handle



GROOMINGS

40-104-10
Clipper Both Sided
Thin & Wide Teeth



40-105-10
Hand sheep clipper
with wooden handle



40-106-10
Hand sheep clipper

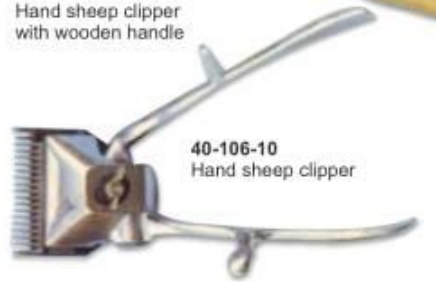

40-107-10
Hand sheep clipper



40-107-10



40-107-10



40-108-10
Hand sheep clipper



40-110-10
Aluminium Mane Comb
with Wooden Handle



40-111-10
Aluminium
Mane Comb



40-112-10
Aluminium
Mane Comb



40-113-10
Aluminium Jockey
Mane Comb



40-114-10
Sheep Shears



40-115-10
Sheep Shears



40-100-12



40-100-13



40-100-14



40-100-15



40-093-09
Hoof Picks



40-095-09
Sheep Hoof Knife



40-096-09
Cow Hoof Knife
with Wooden Handle



40-097-09
Sheep Hoof Knife



40-100-09
Rasp without Handle



40-100-09



40-100-09

Behorner



40-101-09
Rasp Barness Dehorner
with Wooden Handle



40-102-09
Rasp Barness Dehorner
with Metallic Handle and also
available in wooden handle



40-103-09
Rasp Barness Dehorner
with Metallic Handle and also
available in wooden handle

HOOF TOOLS



40-079-08
Hoof Knife, Plastic
Handle with Cap



40-080-08
Hoof Knife Wooden
Handle with Double Edges



40-081-08
Hoof Knife Wooden
Handle with Left Edge



40-082-08
Hoof Knife Wooden
Handle with Right Edge



40-083-08
Hoof Knife Wooden
Handle with Double Edges



40-084-08
Hoof Knife With
Different Blades



40-085-08
Hoof Knife Wooden
Handle with Left Edge



40-086-08
Hoof Knife Wooden
Handle with Double Edges



40-087-08
Hoof Knife Wooden
Handle with Right Edge



40-088-08
Hoof Knife Plastic
Handle with Right Edge



40-089-08
Hoof Knife Plastic
Handle with Left Edge



40-090-08
Hoof Knife Plastic
Handle with Double Edges



40-091-08
Egg But Knife

HOOF TOOLS

HOOF TOOLS



40-070-07
Sheep Hoof Cutter



40-071-07
Heavy Duty Hoof
Claw Cutter With
Interchangeable Blades.



40-067-07
Foot Rotshear with lock pin



40-068-07
Foot Rot Shear



40-068-07 A



40-068-07 A



40-073-07
Stainless Steel Hoof Scraper



40-069-07
Foot Rot Shear



40-074-07
Stainless Steel Hoof Scraper



40-075-07
Stainless Steel Hoof Scraper



HOOF/ FARROER TOOLS

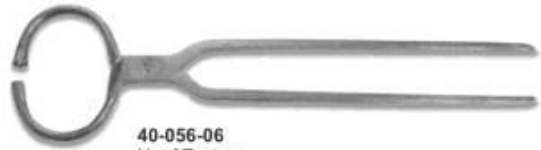

40-056-06
Hoof Tester
Round Large



40-057-06
Shoe Puller



40-058-06
Diamond Farrier
Nippers 15"



40-059-06
Shoe Puller to Grab Hold
of The Shoe Removal



40-060-06
Diamond Shoe Puller & Spreader
Round Knobs on of Handles



40-061-06
Black Steel Crocodile Plier With
Plastic Coated end (clincher)



40-062-06
Black Steel Crocodile
Plier (clincher)



40-063-06
Diamond Nail Puller



40-064-07
Nail Nipper



40-065-07
Professional Hoof Nipper
With Wide Opening



40-066-07
Diamond Farrier
Clincher



40-066-08



TEAT SLITTERS



40-055-07



40-055-08



40-055-09



40-055-10



40-055-11



40-055-12



40-055-13



40-055-14



40-055-15
Marking Ring Applicator
Plastic Made



40-055-16
Marking Ring Applicator
S.S Finish



OBSTETRIC CHAINS & MIKING TUBES



40-055-17 40-055-18 40-055-19 40-055-20

Teat Tumor Extractors



40-055-21 40-055-22 40-055-23 40-055-24

Groove Probe Directors



40-055-25 40-055-26



RING PLAYER & BULL RINGS



40-042-04
Bull Ring Stainless Steel
Sizes are 55mm and 65mm

40-043-04
Bull Ring Stainless Steel
Sizes are 55mm and 65mm



40-036-04
Bull Nose Ring
Applicator With
Vertical Opening Delivered
With A Break-off Screw



40-050-06
Hoof Puncher



40-037-04
Bull Nose Ring
Applicator For Bull Rings



40-051-06
Hoof Forceps



40-038-04
With Pig Staples
Applicator Made of Aluminium
With Adjustment Screw



40-053-06
Hoof Tester



40-039-04
Milk Sucking Preventor Plier
Available In Red Colour Also



40-054-06
Round Hoof Tester



40-041-04
Bull Ring Halter



40-055-06
Flat Hoof Tester



BULL LEADS HOLDER

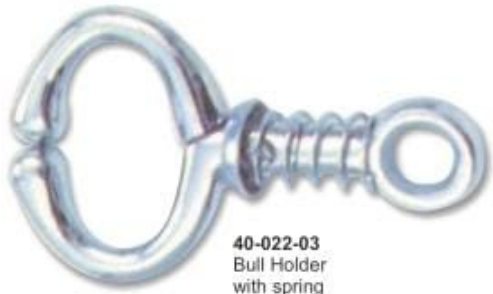

40-022-03
Bull Holder
with spring



40-023-03
Bull Holder
with spring



40-028-03
Bull Holder



40-024-03
Automatic Lock Easily
Released Bull Lead, Aluminum



40-029-03
Bull Holder with chain



40-027-03
Bull Holder Continental
Tong Pattern, 43cm



40-031-03
Krey-Schottler



BULL LEADS- HOLDER



40-015-02
Heavy Duty Bull
Holder with chain



40-012-02
Bull Holder with spring



40-016-02
Heavy Duty Bull
Holder without chain



40-013-02
Bull Holder
with Side Gripe



40-018-02
Bull Holder Harm's With
Rowel Slide



40-014-02
Heavy Duty Bull
Holder with chain



40-021-02
Bull Holder With Spring

CASTRATION FORCEPS



DD-001
Bloodless Castrator
48cm (30cm, 36cm, 40cm)
(For Bulls and Big Animals)



DD-002
Bloodless Castrator
with Cord-Stop
48cm (30cm, 36cm, 40cm)
(For Bulls and Big Animals)



DD-003
Bloodless Castrator
23cm
(for Lambs and Rabbit)



DD-003-PH



DD-006
Heavy Duty Marking
Ring Applicator



DD-007
Castrator Heavy Duty
with Pin



DD-008
De White Emasculator S.S
23cm, 30cm



DD-009
Emasculator Cut The Tail
and Crushes The Blood Vessel
19cm, 23cm, 27cm



DD-1009
Hoof Pressor
Heavy Duty

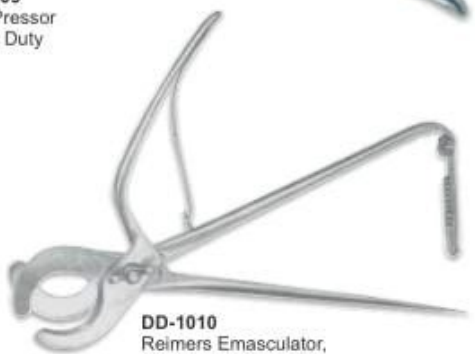

DD-1010
Reimers Emasculator,
for Horses with 3 Arms

THANK YOU



SURGI PROVE

www.surgiprove.com



surgiprove@gmail.com



+923307020002